

SAMSUNG

BESPOKE

Designed for you, by you

Installation guide

A fridge that is
stylishly unique.



Introduction

The Bespoke Fridge. So uniquely you.

Introducing the refrigerator that can stand out or blend in. With our Bespoke Refrigerator range you can now choose your preferred style, colour and finish to create the fridge of your dreams.

Tap into your 'interior designer' and bring your personal vision to life. Our Bespoke Refrigerator range comes in modular or free-standing style and is available in a range of colours and finishes, giving you an exciting blank canvas to work with.

The great thing about Bespoke is that it can grow with you. Integrate new modules when you need more fridge or freezer space for the ultimate versatility in size and style.*

Complimenting the innovations in form are the thoughtful features in function. Our Bespoke refrigerators feature our most efficient cooling technologies, with Triple Cooling™ and All-around Cooling™ that helps to keep food fresh for long. Flexible shelving, Auto-fill Water Jug** and Convertible Freezer Zones deliver convenience.

These are just some of the innovations we've added to our Bespoke range, and it only gets better from here. Welcome to your Bespoke home.

* Only available for Modular models with the stacking kit. Excludes the French Door with beverage centre model RF65A9675AP/SA.

** Automatic re-fill is only available with the French Door with Beverage Centre™, RF65A9675AP/SA and subject to the unit being plumbed.



The refrigerator that is
designed to be seen.



Contents

Introduction	03
Key features	07
Available range	09
Examples of modular configurations	16
Things to consider	22



A Bespoke Refrigerator.
Does it get any cooler?



Key features

Flexible combinations

Need more storage space? You got it.

Bespoke Refrigerators come in classic single door fridge, freezer and even four-door formats for the ultimate versatility in your kitchen. Simply integrate two or more of our models and create the fridge / freezer of your dreams.

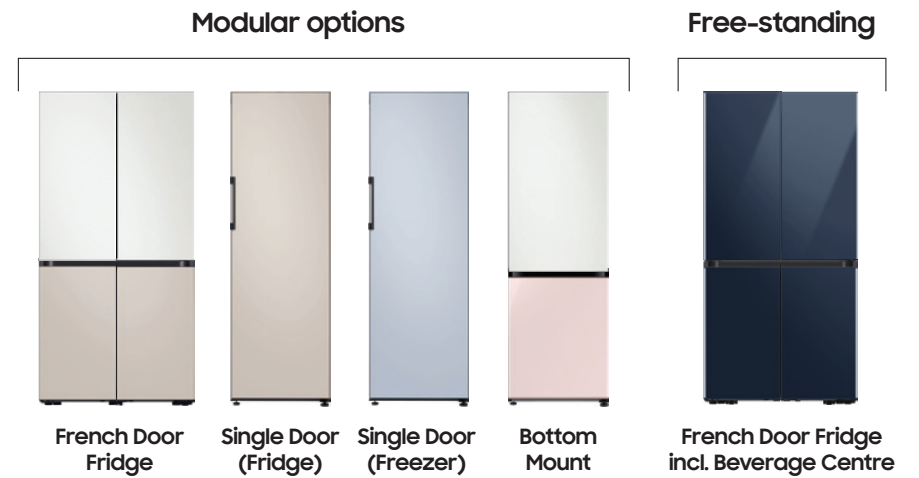

Customisable colour and finish

A fridge that is stylishly unique.

Bring your personal style to the kitchen and beyond. Available in 7 colours and 2 types of finishes, make the kitchen space your blank canvas.

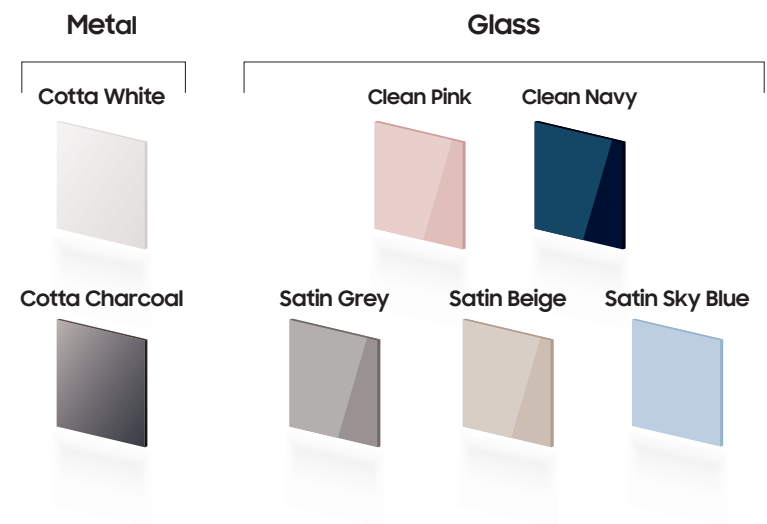

Function with form

Stocked with our top features

Enjoy the best of both worlds with our most innovative cooling technologies available across the Bespoke Refrigerator range for all your beverage and food storage needs. There's something for everyone.

Your new Bespoke refrigerator
is now a designer piece.



Available range

Bespoke Free-standing

Free-Standing units can be installed pretty much anywhere near a plug socket.

Bespoke Modular

Seamlessly integrate multiple modules to increase capacity and create the perfect fridge/freezer combo for you.



Free-standing French Door Fridge*

*Cannot be combined with Modular fridge options.



Modular French Door Fridge



Modular Bottom Mount Fridge



Modular Single Door Freezer or Fridge

Available range

Bespoke Modular Single Door Fridge

SDFX3100N/ RR39A7475AP/SA



Fridge

1. Flexible, modular design
2. Customisable door panel
3. All-around cooling
4. Humidity control box
5. Wine rack
6. Slide & fold shelf
7. Reversible door¹
8. 10 Year compressor warranty²

Freezer

1. Flexible, modular design
2. Customisable door panel
3. Convertible freezer/fridge
4. Slim ice maker
5. No frost
6. Power Freeze Function
7. Reversible door¹
8. 10 Year compressor warranty²

Physical specifications		
Gross Capacity (AU) Total	Refrigerator	387L
	Freezer	323L
Product Dimensions	Width	595 mm
	Height	1853 mm
	Depth (with door handle)	688 mm
	Depth (without door handle)	647 mm
Packaging Dimensions	Width	646 mm
	Height	1950 mm
	Depth	760 mm
Fridge Weight	Product	82 kg
	Packaging	87 kg
Freezer Weight	Product	80.5 kg
	Packaging	85.5 kg

Bespoke Modular Single Door Freezer

SDFX3500N/RZ32A7445AP/SA

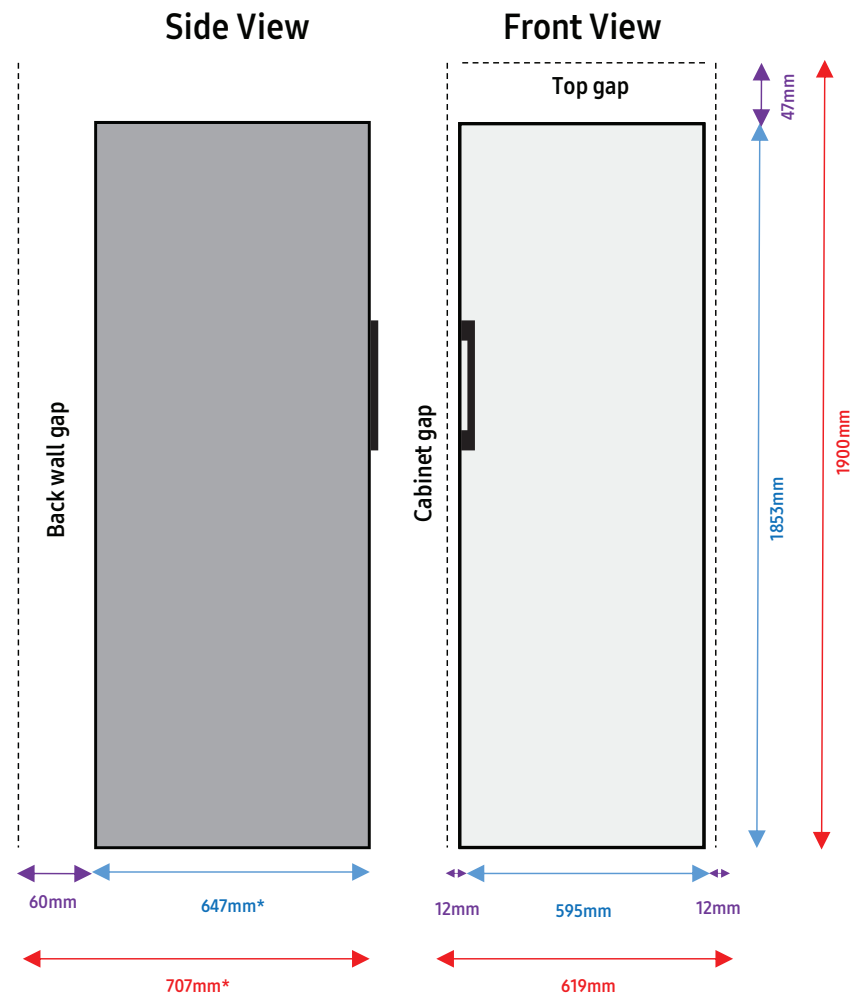

Key	
■	Product Dimensions
■	Recommended gaps
■	Recommended minimum cavity dimensions

*Without handle.

¹Single Door Fridge is right hinged and Single Door Freezer is left hinged when facing it. A Samsung or retailer technician is required to change the default direction. Additional costs may apply. Door direction must be decided at purchase.

²See warranty card or visit www.samsung.com.au for details.

Actual colour may vary. Design, specifications, and colour availability are subject to change without notice.

Non-metric weights and measurements are approximate.

Available range

SRLX4100N

Bespoke Modular Bottom Mount Fridge

RB33T3070AP/SA



1. Flexible, modular design
2. Customisable door panels
3. All-around cooling
4. Power cool / Power freeze
5. Big door bins + wine rack
6. LED lighting
7. Reversible doors*
8. 10 Year compressor warranty¹

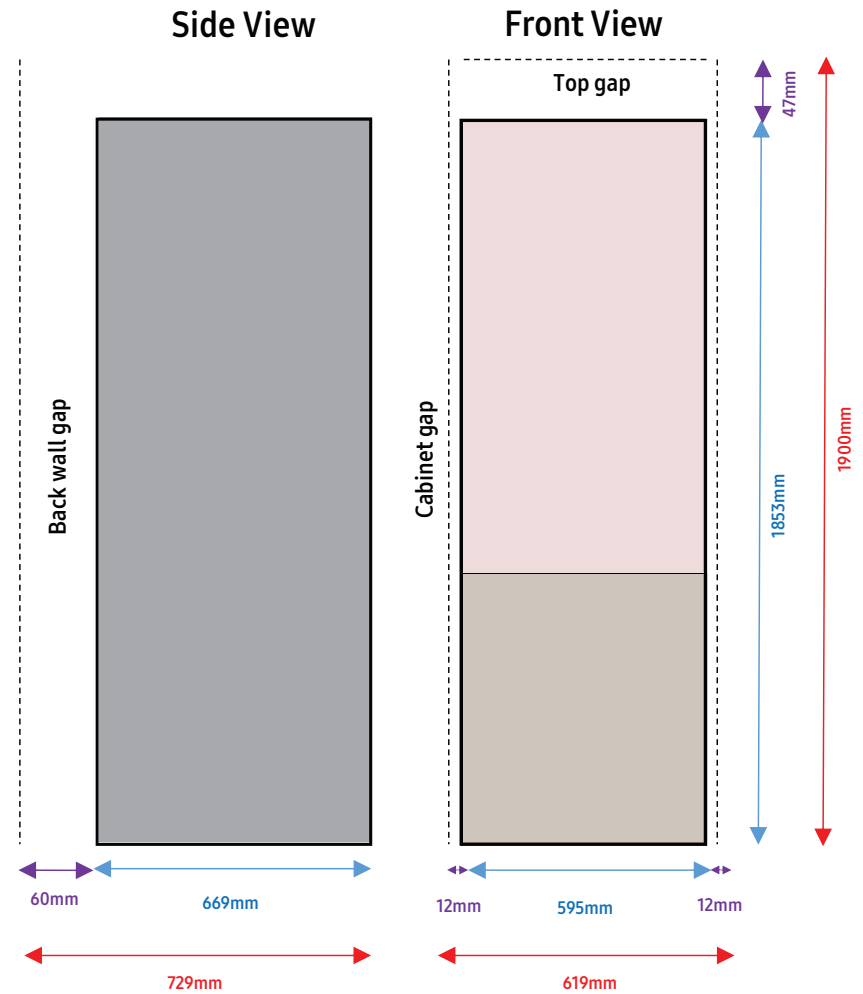

Physical specifications

Gross Capacity (AU)	Total	339L
	Refrigerator	108L
	Freezer	231L
Product Dimensions	Width	595 mm
	Height	1853 mm
	Depth (with door)	669 mm
	Depth (without door)	615 mm
Packaging Dimensions	Width	654 mm
	Height	1947 mm
	Depth	702 mm
Weight	Product	74 kg
	Packaging	79 kg

Key

- Product Dimensions
- Recommended gaps
- Recommended minimum cavity dimensions

¹See warranty card or visit www.samsung.com.au for details.

*This model is right hinged when facing it. A Samsung or retailer technician is required to change the default direction. Additional costs may apply. Door direction must be decided at purchase.

Actual colour may vary. Design, specifications, and colour availability are subject to change without notice.

Non-metric weights and measurements are approximate.

Innovation in design meets
advanced features in function.



Available range

SRFX9500N

Bespoke Modular French Door Fridge

RF60A91RIAP/SA



Side View

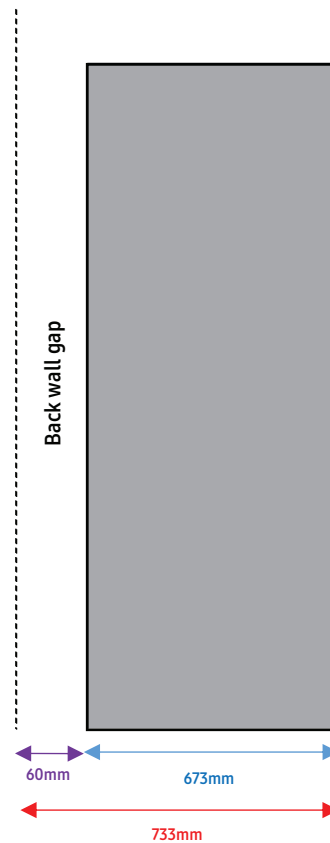

Front View

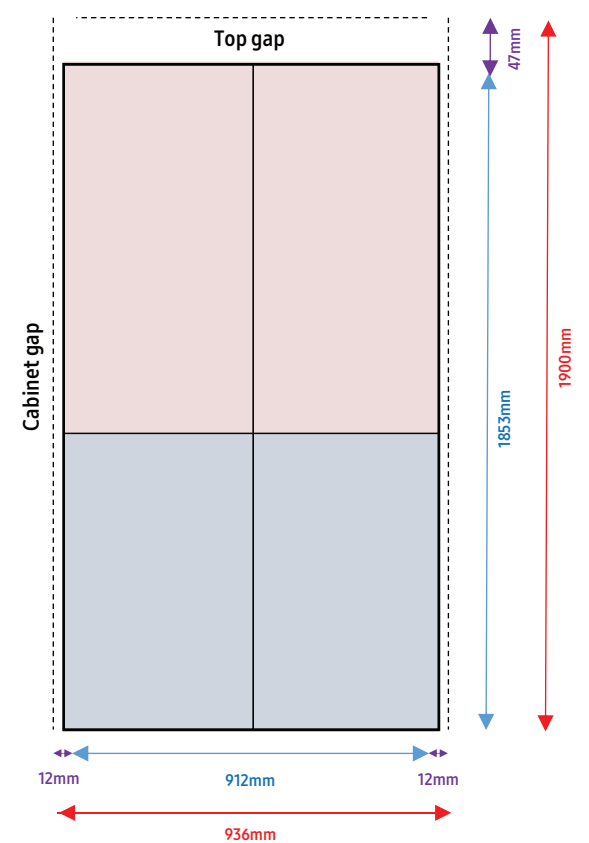

1. Flexible, modular design
2. Customisable door panels
3. Triple cooling™ + metal cooling
4. FlexZone™ + Flex Crisper™
5. Non-plumbed auto ice maker
6. UV deodorising filter
7. LED Lighting
8. Wi-Fi enabled
9. 10 Year compressor warranty¹

Physical specifications

Gross Capacity (AU)	Total	596L
	Refrigerator	381L
	Freezer	215L
Product Dimensions	Width	912 mm
	Height	1853 mm
	Depth (with door)	673 mm
	Depth (without door)	610 mm
Packaging Dimensions	Width	972 mm
	Height	1995 mm
	Depth	776 mm
Weight	Product	132 kg
	Packaging	142 kg
Accessories	Water Filter Model	HAF-QIN

Key

- Product Dimensions
- Recommended gaps
- Recommended minimum cavity dimensions

¹See warranty card or visit www.samsung.com.au for details.

Actual colour may vary. Design, specifications, and colour availability are subject to change without notice.

Non-metric weights and measurements are approximate.

It's your choice.
You decide the style,
colours and finish.



Available range

SRFX9550N

Free-standing French Door Fridge with Beverage Centre™

RF65A9675AP/SA



1. Customisable door panels
2. Beverage centre™ with auto-fill water jug
3. Triple cooling™ + metal cooling
4. Plumbed dual ice maker
5. FlexZone™
6. Power cool function
7. LED lighting
8. Wi-Fi enabled
9. 10 Year compressor warranty¹

Physical specifications		
Gross Capacity (AU)	Total	647L
	Refrigerator	397L
	Freezer	250L
Product Dimensions	Width	912 mm
	Height	1853 mm
	Depth (with door)	731 mm
	Depth (without door)	610 mm
	Packaging Dimensions	Width
Packaging Dimensions	Height	1995 mm
	Depth	776 mm
	Weight	Product
Packaging		149 kg
Accessories	Water Filter Model	HAF-QIN

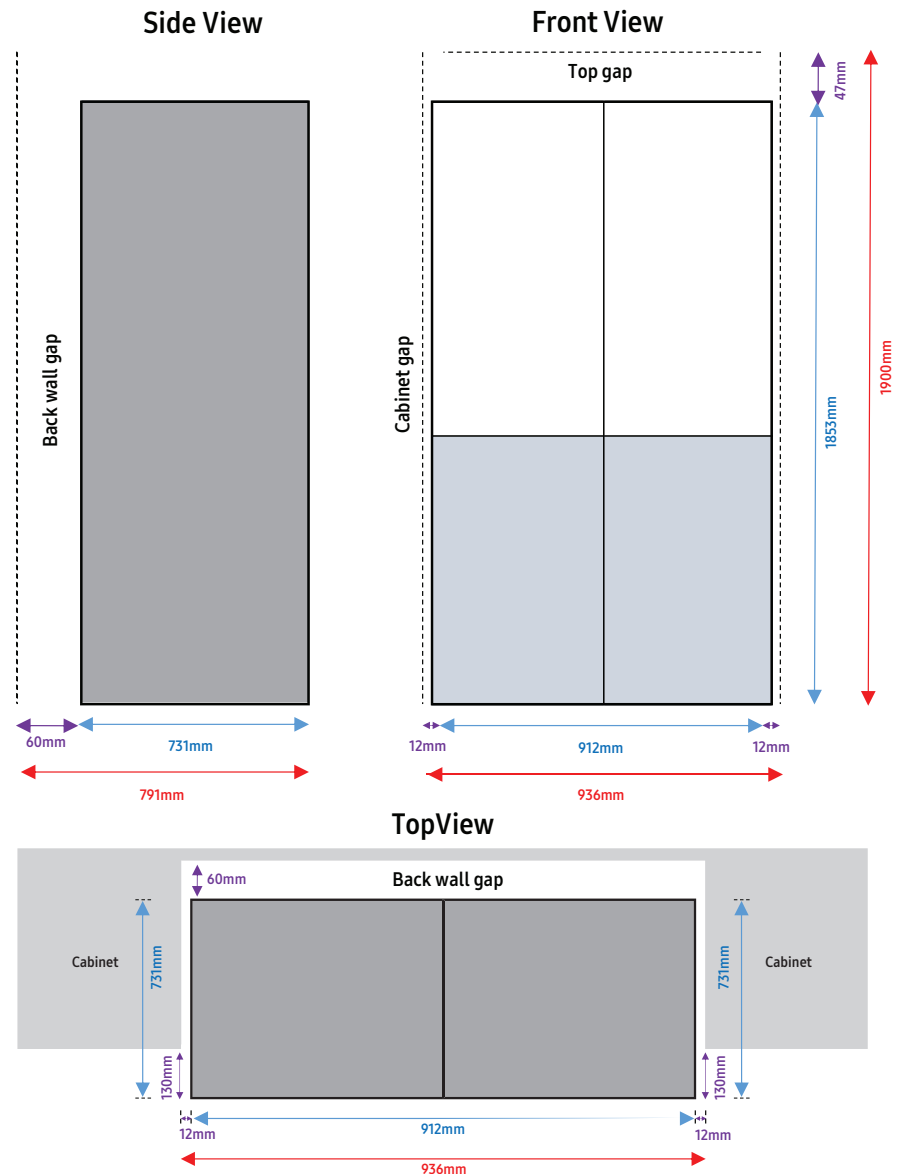

Doors for this model need to sit 130mm outside the fridge cavity to allow for opening space.

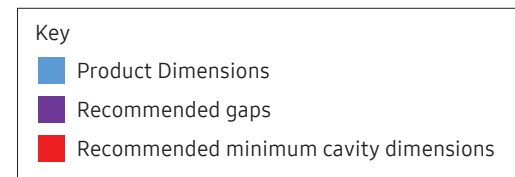

¹See warranty card or visit www.samsung.com.au for details.

NOTE: This product cannot be combined with other products.

Actual colour may vary. Design, specifications, and colour availability are subject to change without notice.

Non-metric weights and measurements are approximate.

Examples of modular configurations

NOTE: the French Door Fridge (673mm) is deeper than the Single Door (647mm).
These are the most commonly expected combinations, not all possible combinations

Modular French Door Fridge + Single Door Fridge or Freezer

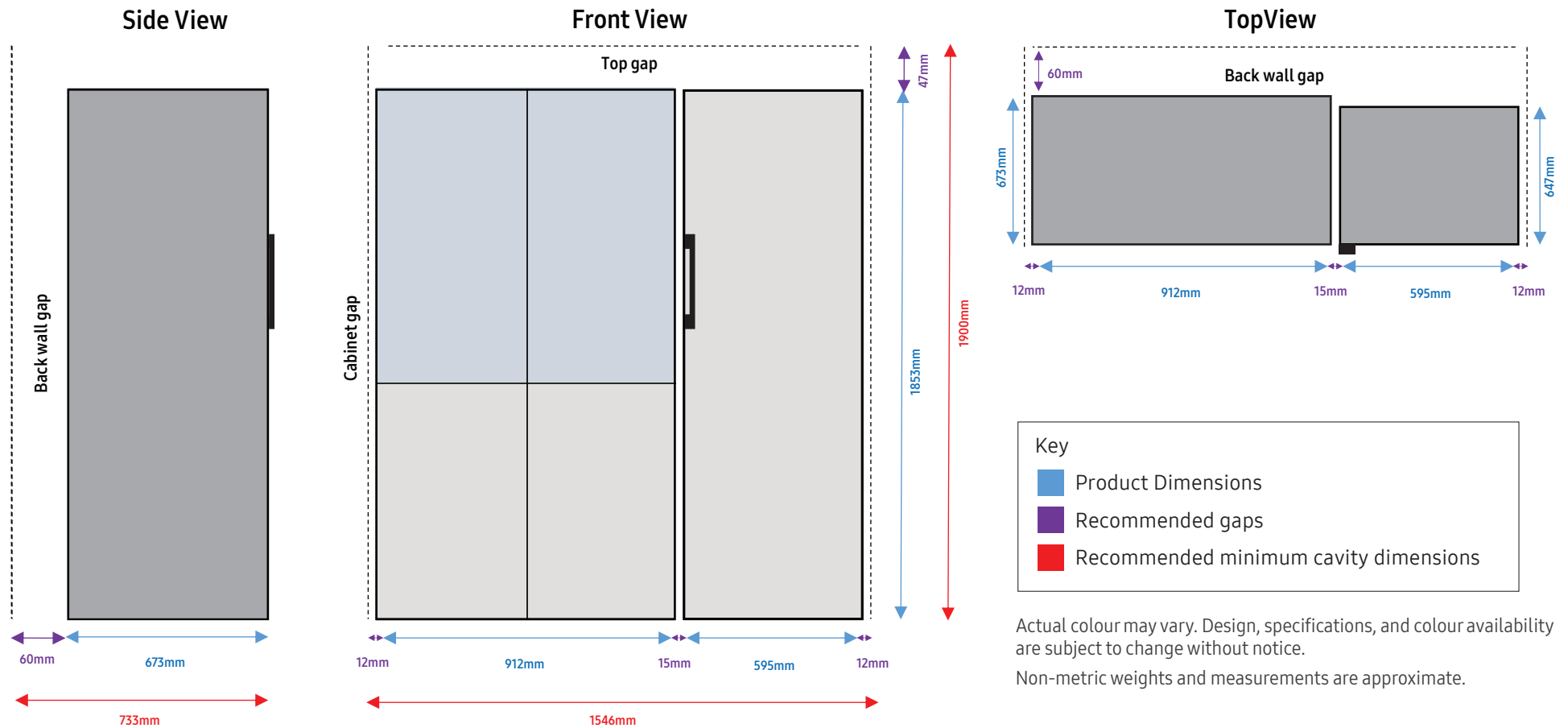

Physical specifications

Recommended distance from back wall	60 mm
Recommended gap from sides of the cabinet	12 mm
Recommended gap between refrigerator units	15 mm
Recommended gap from the top of the fridge to the cabinet	47 mm



Examples of modular configurations

The Bottom Mount Fridge (669mm) is deeper than the Single Door (647mm)
 These are the most commonly expected combinations, not all possible combinations

Modular Bottom Mount Fridge + Single Door Fridge or Freezer

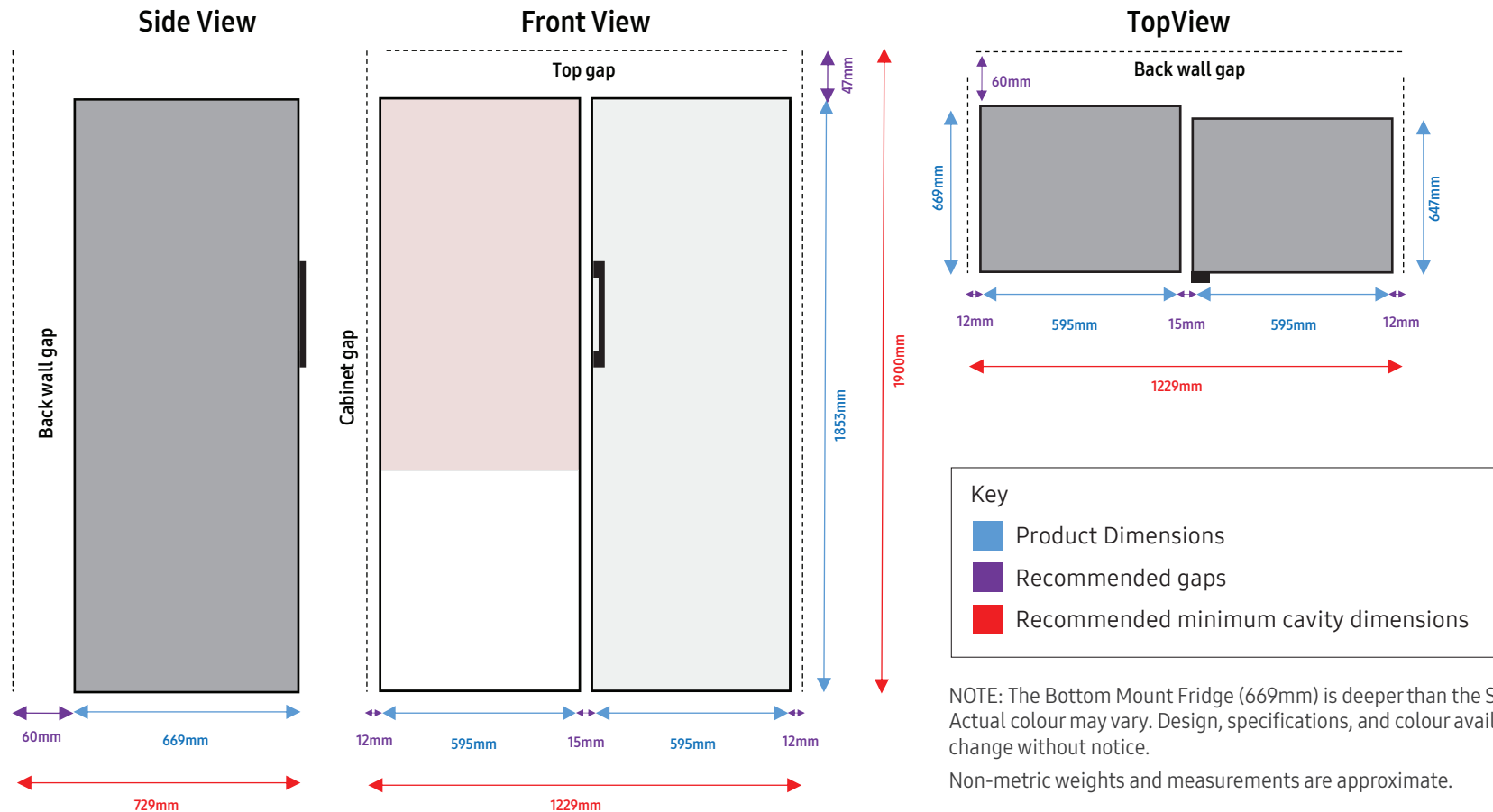

Physical specifications

Recommended distance from back wall	60 mm
Recommended gap from sides of the cabinet	12 mm
Recommended gap between refrigerator units	15 mm
Recommended gap from the top of the fridge to the cabinet	47 mm



The best style of refrigerator
...Is your style

Examples of modular configurations

The Bottom Mount Fridge (669mm) is deeper than the Single Door (647mm). These are the most commonly expected combinations, not all possible combinations.

Modular Bottom Mount Fridge + 2 Single Door Units

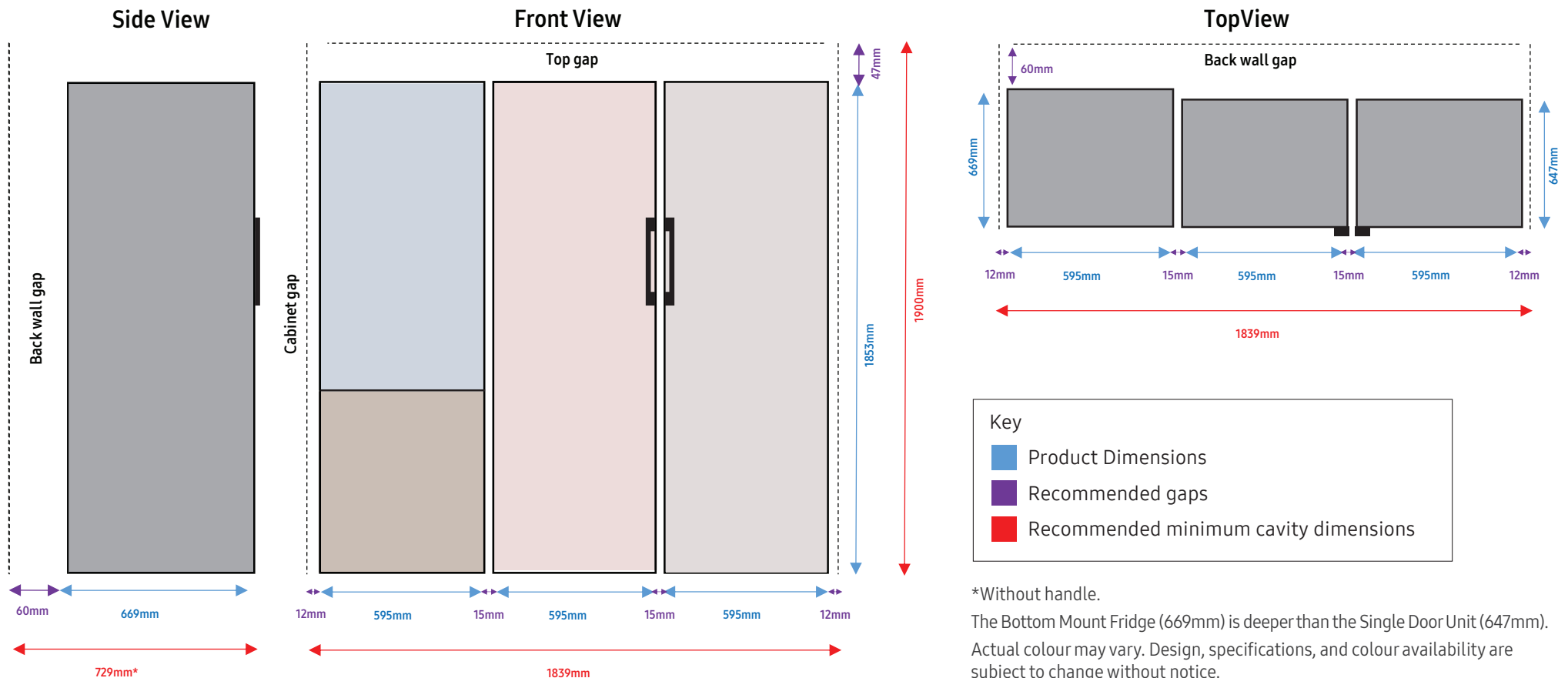

*Without handle.

The Bottom Mount Fridge (669mm) is deeper than the Single Door Unit (647mm).

Actual colour may vary. Design, specifications, and colour availability are subject to change without notice.

Non-metric weights and measurements are approximate.

Physical specifications

Recommended distance from back wall	60 mm
Recommended gap from sides of the cabinet	12 mm
Recommended gap between refrigerator units	15 mm
Recommended gap from the top of the fridge to the cabinet	47 mm



Examples of modular configurations

Modular Single Door Fridge + Single Door Freezer

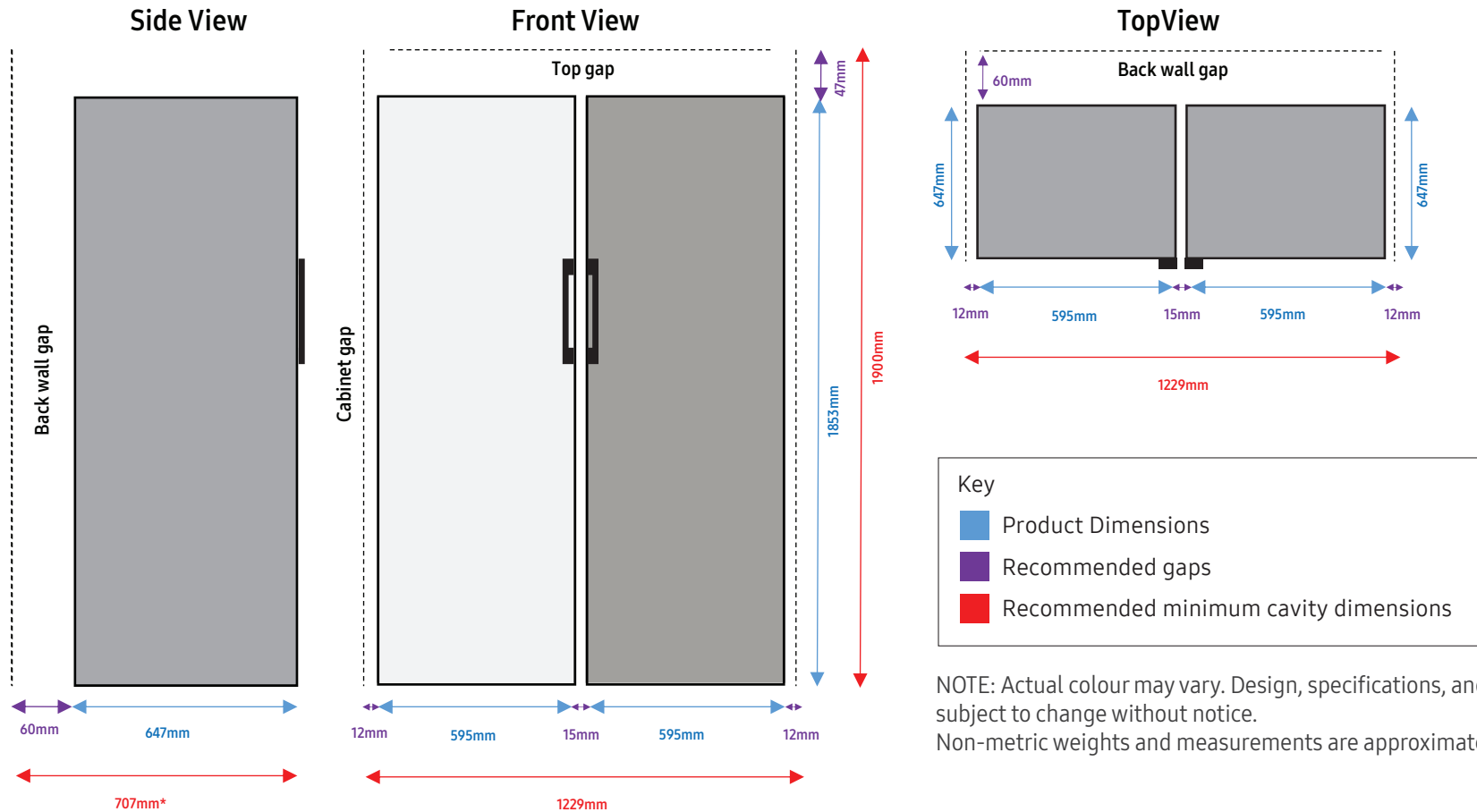

Physical specifications

Recommended distance from back wall	60 mm
Recommended gap from sides of the cabinet	12 mm
Recommended gap between refrigerator units	15 mm
Recommended gap from the top of the fridge to the cabinet	47 mm



Examples of modular configurations

Modular Single Door Fridge x 2 + 1 Single Door Freezer

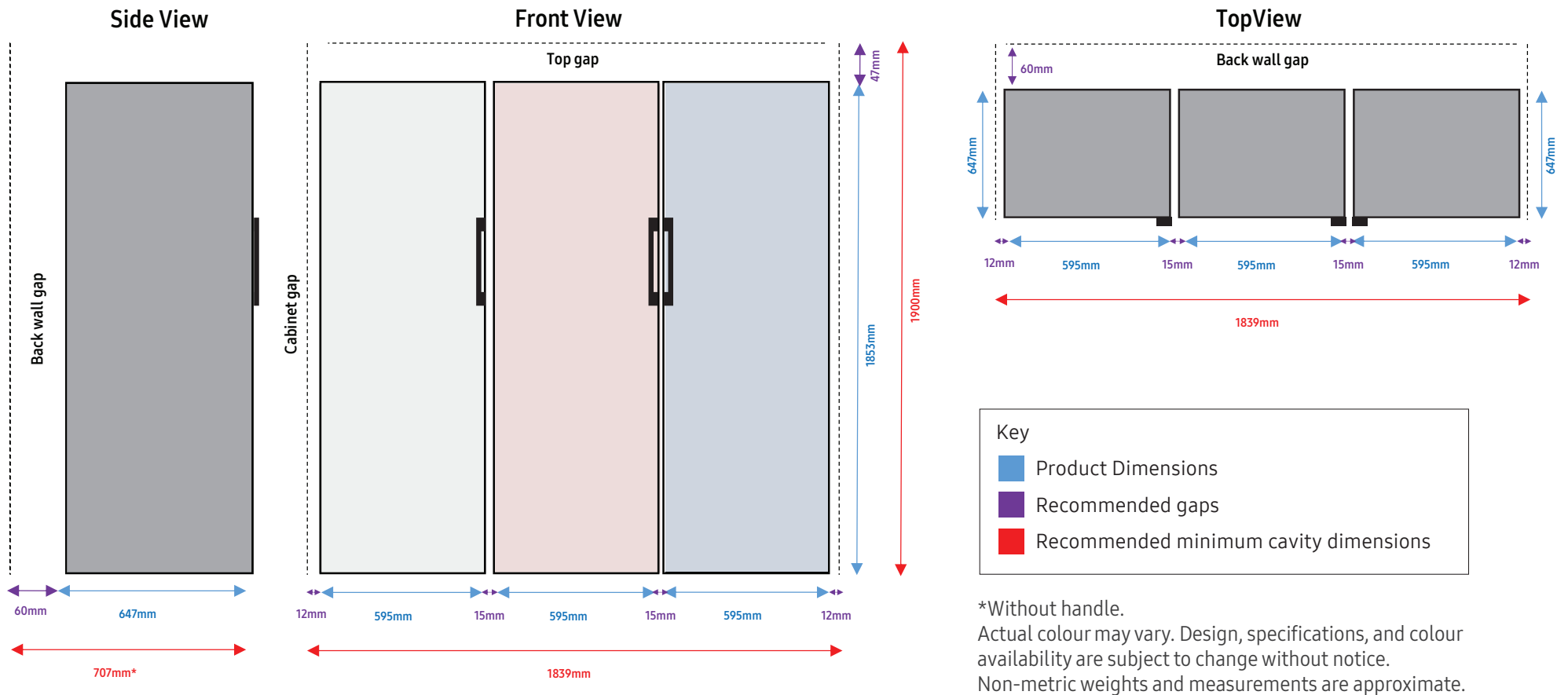

Physical specifications

Recommended distance from back wall	60 mm
Recommended gap from sides of the cabinet	12 mm
Recommended gap between refrigerator units	15 mm
Recommended gap from the top of the fridge to the cabinet	47 mm



Things to consider

1. Direction in which the fridge doors open if two or more modular units are being combined.
2. Combination of fridge units from the modular range. These cannot be combined with the Free-standing French Door Fridge.
3. The recommended gap between outer edges of the fridge units and the cabinet is 12mm.
4. Modular Single Door Fridge and Freezer come with an external 'bar' handle, all others have recessed handles.
5. If combining multiple modular units, please consider the power socket and if there's enough provision units.
6. A Pairing Kit provides a seamless join when installing two or more Bespoke Modular units. This is included in your product delivery and will be handled by a qualified installer at the time of set up and installation.

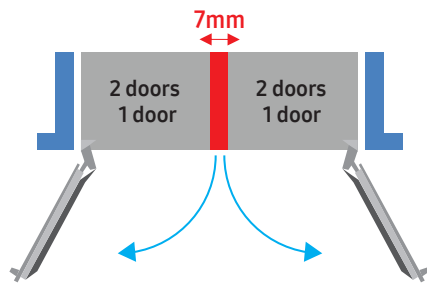

If the doors open in opposite directions.

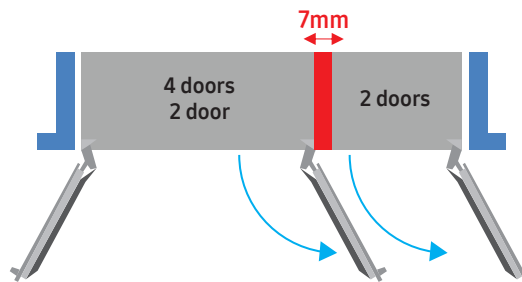

If the doors open in the same direction
(not assembled with a 1-door unit).

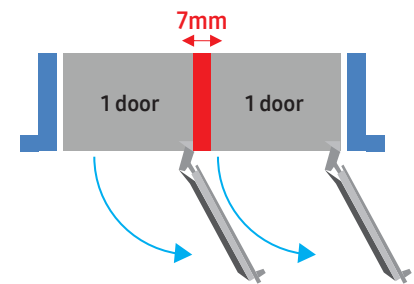

If the doors open in the same direction
(when 1-door units are assembled together).

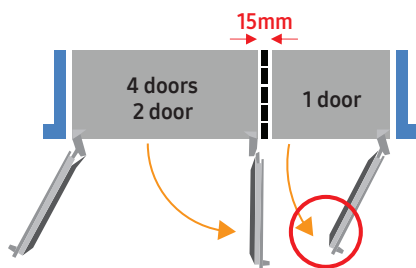

Another product located in the direction
of 1-door handle assembly.

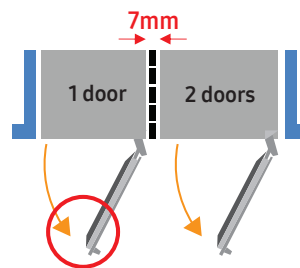

Another product located in the opposite
direction of 1-door handle assembly.

Things to consider

Here are some examples of door directions that require more than 15mm gap between fridges. Fridge doors opening into each other means more gap will be required to allow for door clearance. This will ultimately impact the overall look for your Custom Fridge Design.

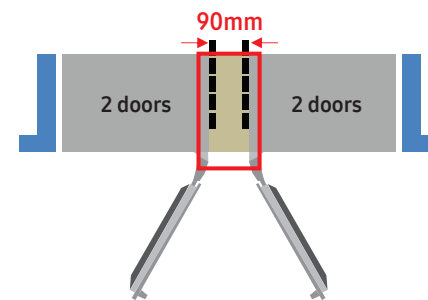
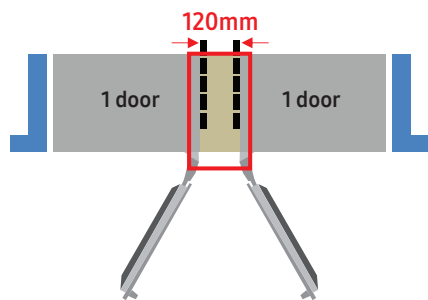
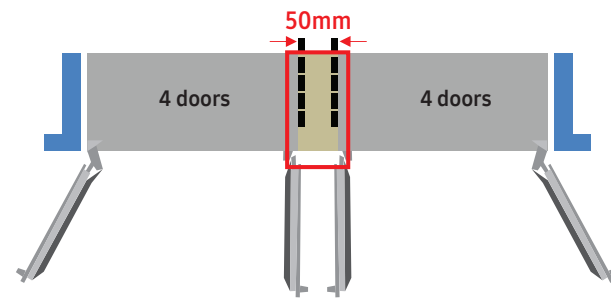
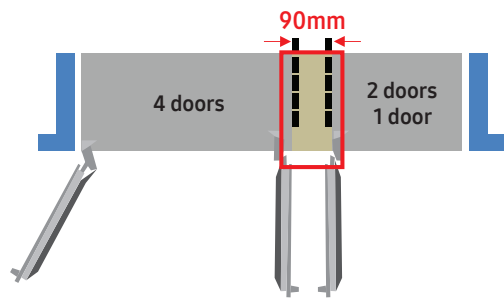



SAMSUNG

Customer Support

For any product or service related queries for Bespoke Refrigerator, please call
Samsung Customer Support on 1300 362 603 / 8am – 8pm, 7 days