

**SAMSUNG**

SM-G960W  
SM-G965W

# User Manual

# Table of Contents

## Basics

- 4 Read me first
- 6 Device overheating situations and solutions
- 10 Device layout and functions
- 16 Battery
- 21 SIM or USIM card (nano-SIM card)
- 24 Memory card (microSD card)
- 28 Turning the device on and off
- 29 Initial setup
- 32 Samsung account
- 34 Transferring data from your previous device
- 36 Understanding the screen
- 49 Notification panel
- 51 Entering text

## Apps and features

- 54 Installing or uninstalling apps
- 56 Bixby
- 82 Phone
- 87 Contacts
- 91 Messages
- 94 Internet
- 96 Email
- 97 Camera
- 128 Gallery
- 134 Always On Display
- 136 Edge screen
- 143 Multi window
- 149 Samsung Pay
- 152 Samsung Gear
- 153 Samsung Members
- 154 Samsung Notes
- 155 Calendar
- 156 Samsung Health
- 163 Voice Recorder
- 165 My Files
- 165 Clock
- 167 Calculator
- 167 Game Launcher
- 170 SmartThings
- 174 Sharing content
- 175 Samsung DeX
- 186 Connecting to an external display
- 187 Google apps

## Settings

- 190 Introduction
- 190 Connections
  - 191 Wi-Fi
  - 194 Bluetooth
  - 196 Data saver
  - 197 NFC and payment
  - 199 Mobile Hotspot and Tethering
  - 201 More connection settings
- 204 Sounds and vibration
  - 205 Dolby Atmos (surround sound)
- 205 Notifications
- 206 Display
  - 207 Blue light filter
  - 208 Changing the screen mode or adjusting the display colour
  - 209 Screen resolution
  - 209 Screensaver
- 210 Wallpapers and themes
- 210 Advanced features
  - 212 Dual Messenger
- 213 Device maintenance
- 216 Apps
- 216 Lock screen and security
  - 218 Smart Lock
  - 218 Intelligent Scan
  - 221 Face recognition
  - 223 Iris recognition
  - 228 Fingerprint recognition
  - 231 Samsung Pass
  - 235 Secure Folder

- 239 Cloud and accounts
  - 240 Samsung Cloud
  - 242 Smart Switch
- 245 Google
- 246 Accessibility
- 246 General management
- 247 Software update
- 248 User manual
- 248 About phone

## Appendix

- 249 Accessibility
- 267 Troubleshooting
- 274 Replace the battery

## Health and Safety

# Basics

## Read me first

Please read this manual before using the device to ensure safe and proper use.

- Descriptions are based on the device's default settings.
- Some content may differ from your device depending on the region, service provider, model specifications, or device's software.
- Content (high quality content) that requires high CPU and RAM usage will affect the overall performance of the device. Apps related to the content may not work properly depending on the device's specifications and the environment that it is used in.
- Samsung is not liable for performance issues caused by apps supplied by providers other than Samsung.
- Samsung is not liable for performance issues or incompatibilities caused by edited registry settings or modified operating system software. Attempting to customize the operating system may cause the device or apps to work improperly.
- Software, sound sources, wallpapers, images, and other media provided with this device are licensed for limited use. Extracting and using these materials for commercial or other purposes is an infringement of copyright laws. Users are entirely responsible for illegal use of media.
- You may incur additional charges for data services, such as messaging, uploading and downloading, auto-syncing, or using location services, depending on your data plan. For large data transfers, it is recommended to use the Wi-Fi feature.
- Default apps that come with the device are subject to updates and may no longer be supported without prior notice. If you have questions about an app provided with the device, contact a Samsung Service Centre. For user-installed apps, contact service providers.
- Modifying the device's operating system or installing software from unofficial sources may result in device malfunctions and data corruption or loss. These actions are violations of your Samsung licence agreement and will void your warranty.

## Maintaining water and dust resistance

Your device supports water- and dust-resistance. Follow these tips carefully to maintain the water- and dust-resistance of your device. Failure to do so may result in damage to your device.

- Do not immerse the device in fresh water deeper than 1.5 m or keep it submerged for more than 30 minutes. If you immerse the device in any liquid other than fresh water, such as salt water, ionized water, or an alcoholic beverage, liquid will enter the device faster.
- Do not expose the device to **water moving with force**.
- If the device is exposed to fresh water, dry it thoroughly with a clean, soft cloth. If the device is exposed to other liquids, such as salt water, ionized water, or an alcoholic beverage, rinse it with fresh water and dry it thoroughly with a clean, soft cloth. If you do not follow these instructions, the device's performance and appearance may be affected.
- **If the device has been immersed in water or the microphone or speaker is wet**, sound may not be heard clearly during a call. After wiping the device with a dry cloth, dry it thoroughly before using it.
- The touchscreen and other features may not work properly **if the device is used in water**.
- **If the device is dropped or receives an impact**, the water- and dust-resistant features of the device may be damaged.
- **Your device has been tested in a controlled environment and certified to be water- and dust-resistant in specific situations (meets requirements of classification IP68 as described by the international standard IEC 60529-Degrees of Protection provided by Enclosures [IP Code]; test conditions: 15-35 °C, 86-106 kPa, fresh water, 1.5 metre, 30 minutes). Despite this classification, it is still possible for your device to be damaged in certain situations.**

## Instructional icons



**Warning:** situations that could cause injury to yourself or others



**Caution:** situations that could cause damage to your device or other equipment



**Notice:** notes, usage tips, or additional information

## Device overheating situations and solutions

### When the device heats up while charging the battery

While charging, the device and the charger may become hot. During wireless charging or fast charging, the device may feel hotter to the touch. This does not affect the device's lifespan or performance and is in the device's normal range of operation. If the battery becomes too hot, the charger may stop charging.

#### Do the following when the device heats up:

- Disconnect the charger from the device and close any running apps. Wait for the device to cool down and then begin charging the device again.
- If the lower part of the device overheats, it could be because the connected USB cable is damaged. Replace the damaged USB cable with a new Samsung-approved one.
- When using a wireless charger, do not place foreign materials, such as metal objects, magnets, and magnetic stripe cards, between the device and the wireless charger.



The wireless charging or fast charging feature is only available on supported models.

## When the device heats up during use

When you use features or apps that require more power or use them for extended periods, your device may temporarily heat up due to increased battery consumption. Close any running apps and do not use the device for a while.

The following are examples of situations in which the device may overheat. Depending on the functions and apps you use, these examples may not apply to your model.

- During the initial setup after purchase or when restoring data
- When downloading large files
- When using apps that require more power or using apps for extended periods
  - When playing high-quality games for extended periods
  - When recording videos for extended periods
  - When streaming videos while using the maximum brightness setting
  - When connecting to a TV
- While multitasking (or, when running many apps in the background)
  - When using Multi window
  - When updating or installing apps while recording videos
  - When downloading large files during a video call
  - When recording videos while using a navigation app
- When using large amount of data for syncing with the cloud, email, or other accounts
- When using a navigation app in a car while the device is placed in direct sunlight
- When using the mobile hotspot and tethering feature
- When using the device in areas with weak signals or no reception
- When charging the battery with a damaged USB cable
- When the device's multipurpose jack is damaged or exposed to foreign materials, such as liquid, dust, metal powder, or pencil lead
- When you are roaming

### **Do the following when the device heats up:**

- Keep the device updated with the latest software.
- Conflicts between running apps may cause the device to heat up. Restart the device.
- Deactivate the Wi-Fi, GPS, and Bluetooth features when not using them.
- Close apps that increase battery consumption or that run in the background when not in use.
- Delete unnecessary files or unused apps.
- Decrease the screen brightness.
- If the device overheats or feels hot for a prolonged period, do not use it for a while. If the device continues to overheat, contact a Samsung Service Centre.

### **Device limitations when the device overheats**

When the device heats up, the features and performance may be limited or the device may turn off to cool down. The feature is only available on supported models.

- If the device becomes hotter than usual, a device overheating message will appear. To lower the device's temperature, the screen brightness and the performance speed will be limited and battery charging will stop. Running apps will be closed and you will only be able to make emergency calls until the device cools down.
- If the device overheats or feels hot for a prolonged period, a power off message will appear. Turn off the device, and wait until it cools down.



## Precautions for operating environment

Your device may heat up due to the environment in the following conditions. Use caution to avoid shortening the battery's lifespan, damaging the device, or causing a fire.

- Do not store your device in very cold or very hot temperatures.
- Do not expose your device to direct sunlight for extended periods.
- Do not use or store your device for extended periods in very hot areas, such as inside a car in the summertime.
- Do not place the device in any areas that may overheat, such as on an electric heating mat.
- Do not store your device near or in heaters, microwaves, hot cooking equipment, or high pressure containers.
- Never use a damaged charger or battery.

# Device layout and functions

## Package contents

Refer to the quick start guide for package contents.



- The items supplied with the device and any available accessories may vary, depending on the region or service provider.
- The supplied items are designed only for this device and may not be compatible with other devices.
- Appearances and specifications are subject to change without prior notice.
- You can purchase additional accessories from your local Samsung retailer. Make sure they are compatible with the device before purchase.
- Use only Samsung-approved accessories. Using unapproved accessories may cause performance problems and malfunctions that are not covered by the warranty.
- Availability of all accessories is subject to change depending entirely on manufacturing companies. For more information about available accessories, refer to the Samsung website.

## Device layout

### ► Galaxy S9 models:

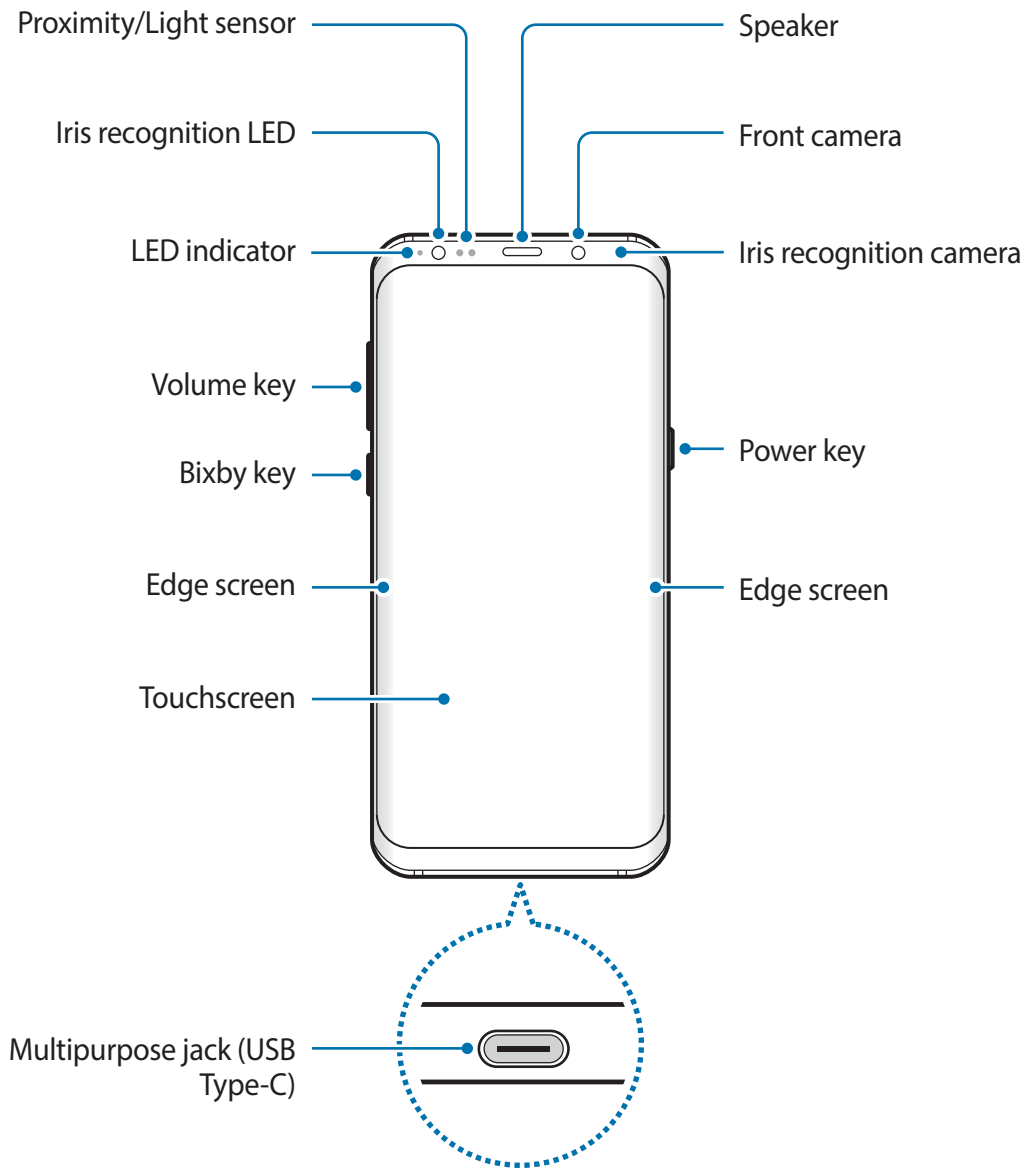

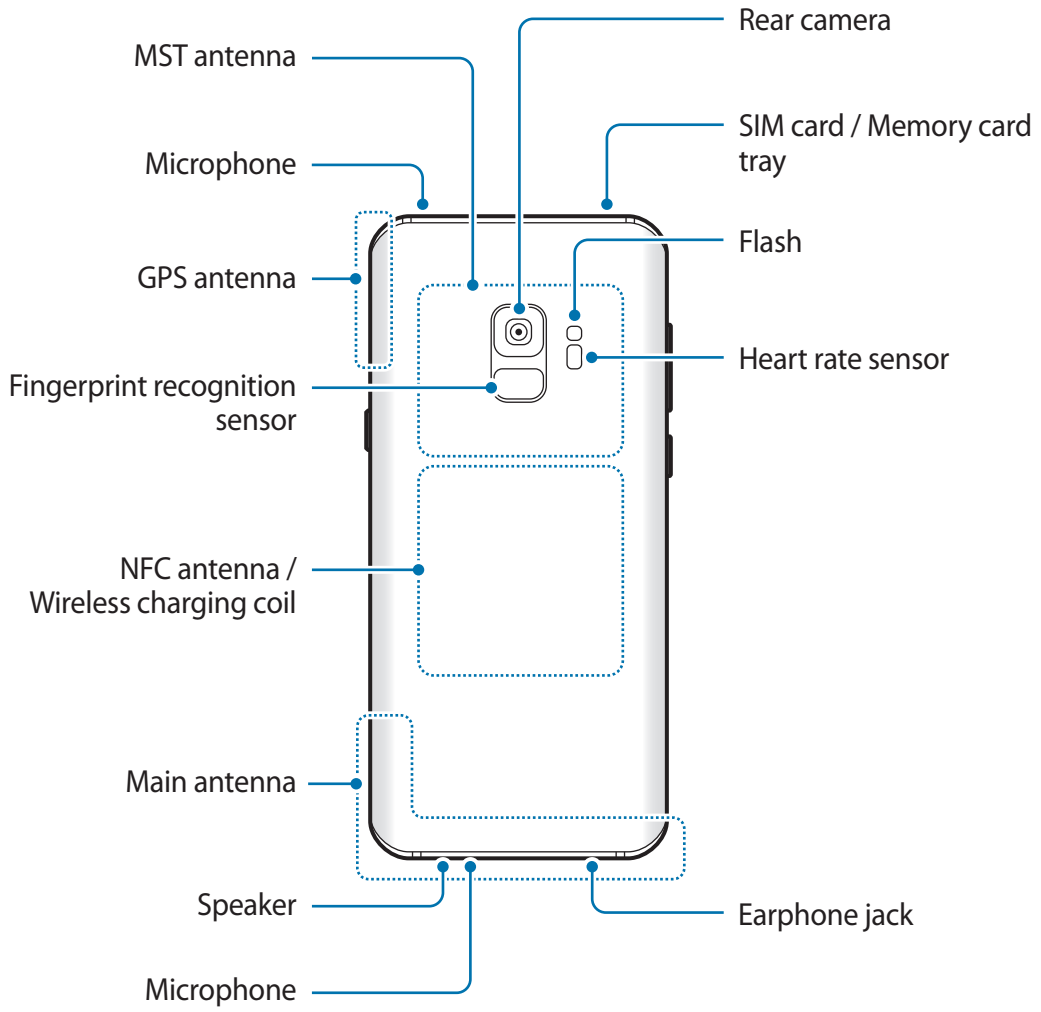

► **Galaxy S9+ models:**

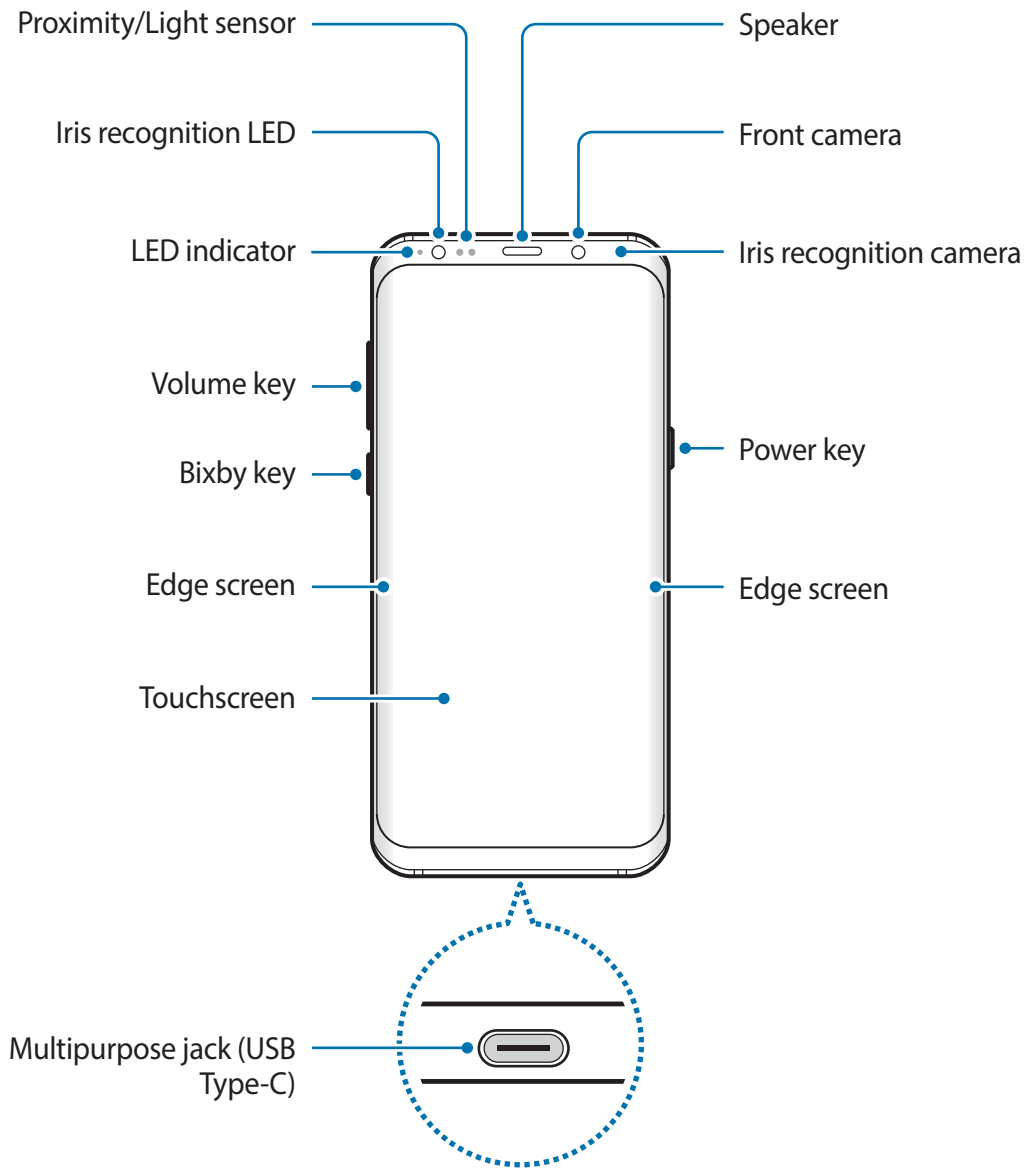

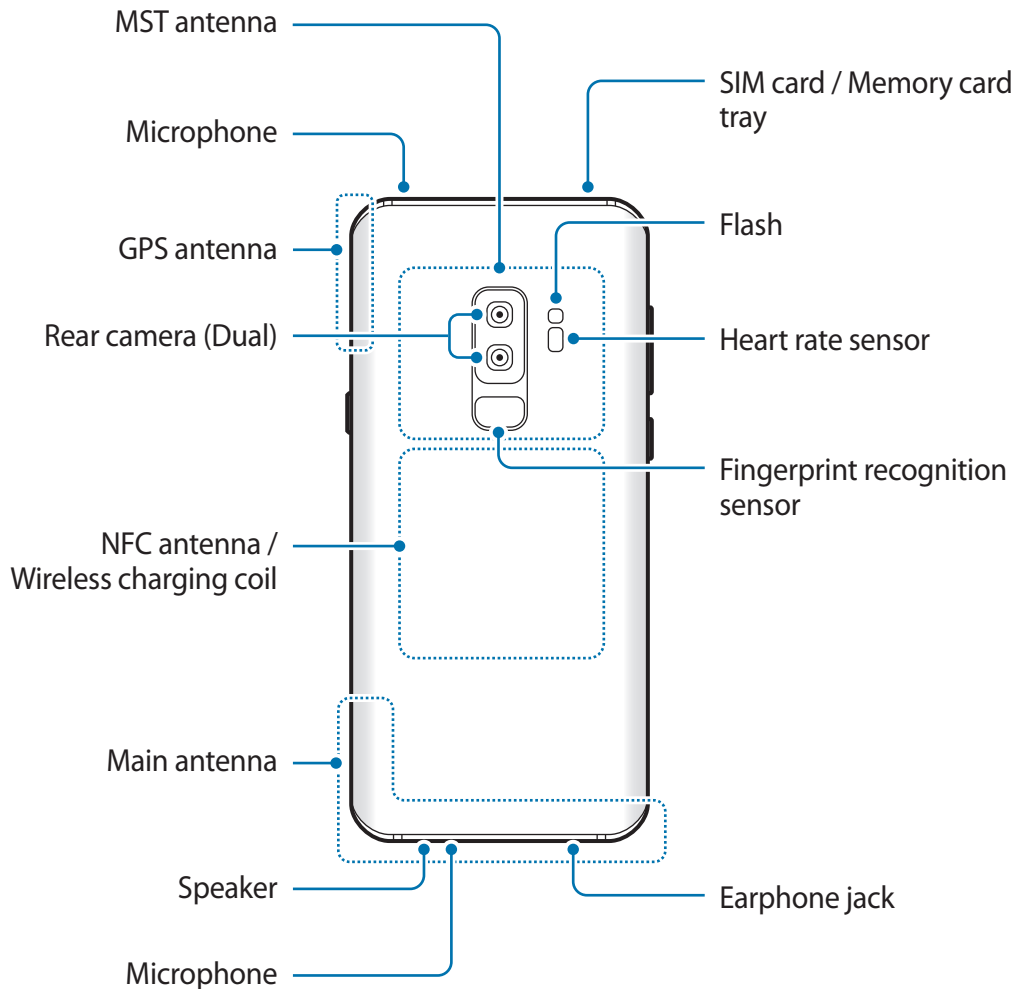

When using the speakers, such as when playing media files or using speakerphone, do not place the device close to your ears.



- Connectivity problems and battery drain may occur in the following situations:
  - If you attach metallic stickers on the antenna area of the device
  - If you attach a device cover made with metallic material to the device
  - If you cover the device's antenna area with your hands or other objects while using certain features, such as calls or the mobile data connection
- Using a Samsung-approved screen protector is recommended. Unapproved screen protectors may cause the sensors to malfunction.
- Do not cover the proximity/light sensor area with screen accessories, such as a screen protector or stickers. Doing so may cause the sensor to malfunction.
- The colours on the Edge screen may look different depending on your viewing position.

## Hard keys

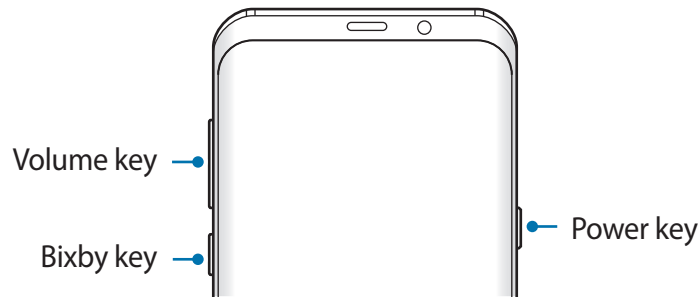

| Key    | Function   |
|--------|--|
| Power  | <ul style="list-style-type: none"> <li>• Press and hold to turn the device on or off.</li> <li>• Press to turn on or lock the screen.</li> </ul>   |
| Bixby  | <ul style="list-style-type: none"> <li>• Press to open Bixby Home. Refer to <a href="#">Bixby</a> for more information.</li> <li>• Press and hold to launch Bixby Voice. Refer to <a href="#">Bixby Voice</a> for more information.</li> </ul> |
| Volume | <ul style="list-style-type: none"> <li>• Press to adjust the device volume.</li> </ul>   |

## Soft buttons

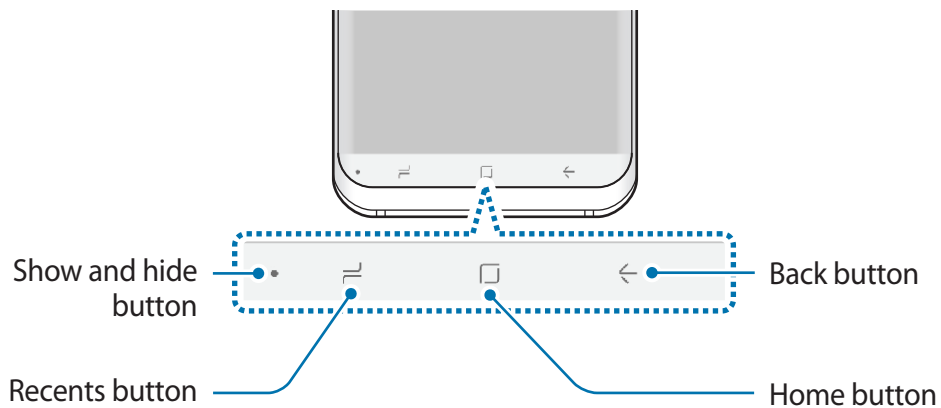

When you turn on the device, the soft buttons will appear at the bottom of the screen. The soft buttons are set to the Recents button, Home button, and Back button by default. Refer to [Navigation bar \(soft buttons\)](#) for more information.

# Battery

## Charging the battery

Charge the battery before using it for the first time or when it has been unused for extended periods.



Use only Samsung-approved chargers, batteries, and cables. Unapproved chargers or cables can cause the battery to explode or damage the device.



- Connecting the charger improperly may cause serious damage to the device. Any damage caused by misuse is not covered by the warranty.
- Use only the USB Type-C cable supplied with the device. The device may be damaged if you use a Micro USB cable.



To save energy, unplug the charger when not in use. The charger does not have a power switch, so you must unplug the charger from the electric socket when not in use to avoid wasting power. The charger should remain close to the electric socket and easily accessible while charging.

- 1 Connect the USB cable to the USB power adapter.
- 2 Plug the USB cable into the device's multipurpose jack.

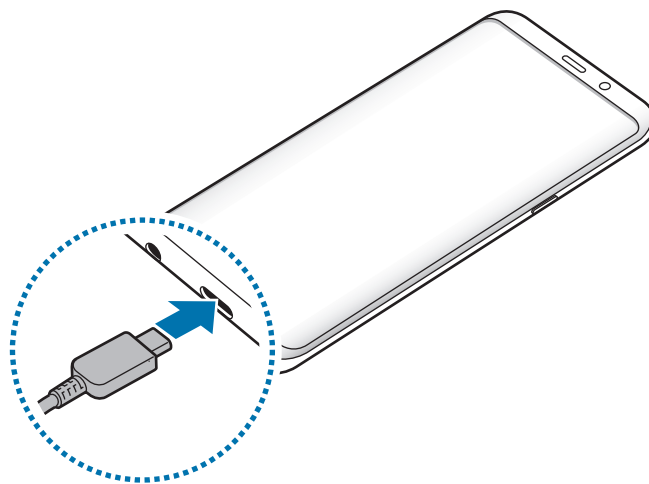



- 3 Plug the USB power adapter into an electric socket.
- 4 After fully charging, disconnect the charger from the device. Then, unplug the charger from the electric socket.

## Charging other devices

Use the USB connector (USB Type-C) to charge another mobile device with your device's battery.

Plug the USB connector (USB Type-C) into your device's multipurpose jack, and connect your device and the other device via the other device's USB cable.

When charging starts, the battery charging icon will appear on the other device's screen.

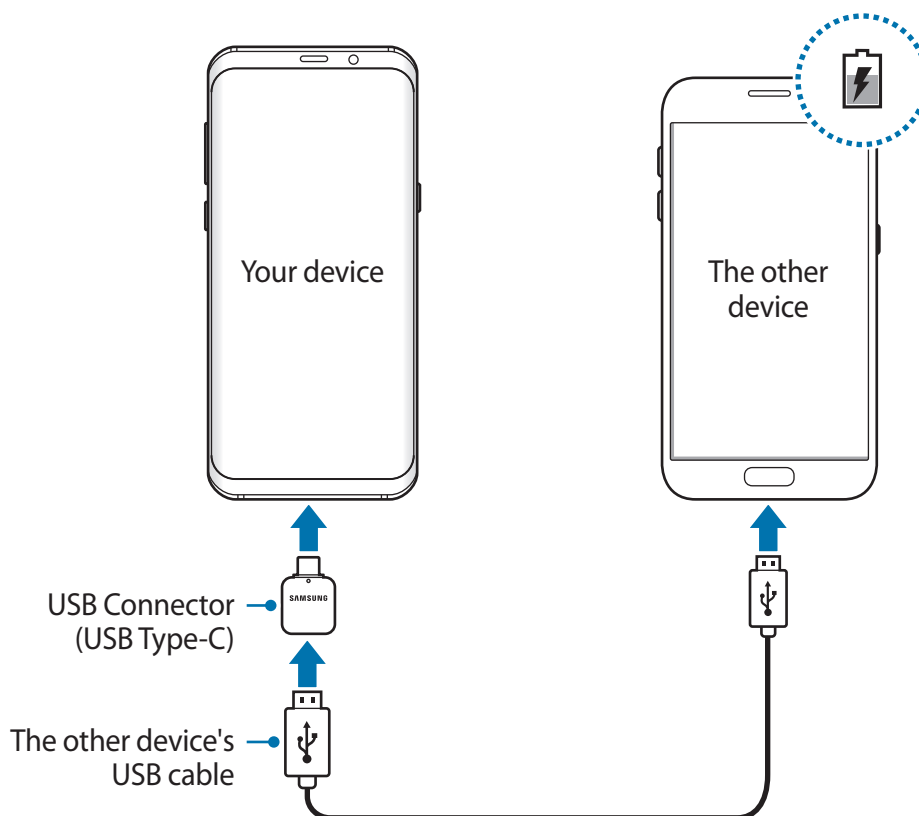

The app selection pop-up window that appears on your device is for data transfer. Do not select an app from the pop-up window.

## Reducing the battery consumption

Your device provides various options that help you conserve battery power.

- Optimize the device using the device maintenance feature.
- When you are not using the device, turn off the screen by pressing the Power key.
- Activate power saving mode.
- Close unnecessary apps.
- Deactivate the Bluetooth feature when not in use.
- Deactivate the Wi-Fi feature when not in use.
- Deactivate auto-syncing of apps that need to be synced.
- Decrease the backlight time.
- Decrease the screen brightness.

## Battery charging tips and precautions

- When the battery power is low, the battery icon appears empty.
- If the battery is completely discharged, the device cannot be turned on immediately when the charger is connected. Allow a depleted battery to charge for a few minutes before turning on the device.
- If you use multiple apps at once, network apps, or apps that need a connection to another device, the battery will drain quickly. To avoid losing power during a data transfer, always use these apps after fully charging the battery.
- Using a power source other than the charger, such as a computer, may result in a slower charging speed due to a lower electric current.
- The device can be used while it is charging, but it may take longer to fully charge the battery.
- If the device receives an unstable power supply while charging, the touchscreen may not function. If this happens, unplug the charger from the device.

- While charging, the device and the charger may heat up. This is normal and should not affect the device's lifespan or performance. If the battery gets hotter than usual, the charger may stop charging.
- If you charge the device while the multipurpose jack is wet, the device may be damaged. Thoroughly dry the multipurpose jack before charging the device.
- If the device is not charging properly, take the device and the charger to a Samsung Service Centre.

## Fast charging

The device has a built-in fast charging feature. You can charge the battery more quickly while the device or its screen is turned off.

### Increasing the charging speed

To increase the charging speed, turn the device or its screen off when you charge the battery. While charging the battery when the device is turned off, the ⚡ icon appears on the screen.

If the fast charging feature is not activated, launch the **Settings** app, tap **Device maintenance** → **Battery** →  → **Advanced settings**, and then tap the **Fast cable charging** switch to activate it.



- You cannot use the built-in fast charging feature when you charge the battery using a standard battery charger.
- If the device heats up or the ambient air temperature rises, the charging speed may decrease automatically. This is a normal operating condition to prevent damage to the device.

## Wireless charging

The device has a built-in wireless charging coil. You can charge the battery using a wireless charger (sold separately).

### Fast wireless charging

You can charge your device faster using the fast wireless charging feature. To use this feature, you must use a charger and components that support the fast wireless charging feature.

If the fast wireless charging feature is not activated, launch the **Settings** app, tap **Device maintenance** → **Battery** →  → **Advanced settings**, and then tap the **Fast wireless charging** switch to activate it.



- The on/off option will be added in your device's settings menu when you first place it on the charger.
- A fan inside the charger may produce noise during fast wireless charging.

### Charging the battery

- 1 Place the centre of the device's back on the centre of the wireless charger.

The estimated charging time will appear on the screen. The actual charging time may vary depending on the charging conditions.

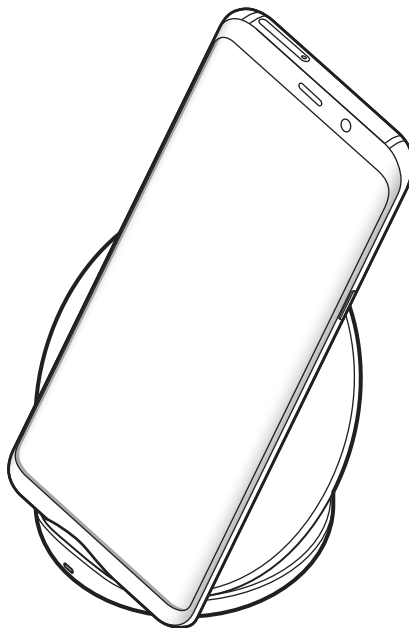

2 After fully charging, disconnect the device from the wireless charger.



### Precautions for wireless charging

- Do not place the device on the wireless charger with a credit card or radio-frequency identification (RFID) card (such as a transportation card or a key card) placed between the back of the device and the device cover.
- Do not place the device on the wireless charger when conductive materials, such as metal objects and magnets, are placed between the device and the wireless charger.

The device may not charge properly or may overheat, or the device and the cards may be damaged.



- If you use the wireless charger in areas with weak network signals, you may lose network reception.
- Use Samsung-approved wireless chargers. If you use other wireless chargers, the battery may not charge properly.

## SIM or USIM card (nano-SIM card)

### Installing the SIM or USIM card

Insert the SIM or USIM card provided by the mobile telephone service provider.



Use caution not to lose or let others use the SIM or USIM card. Samsung is not responsible for any damages or inconveniences caused by lost or stolen cards.



Some LTE services may not be available depending on the service provider. For more information about service availability, contact your service provider.

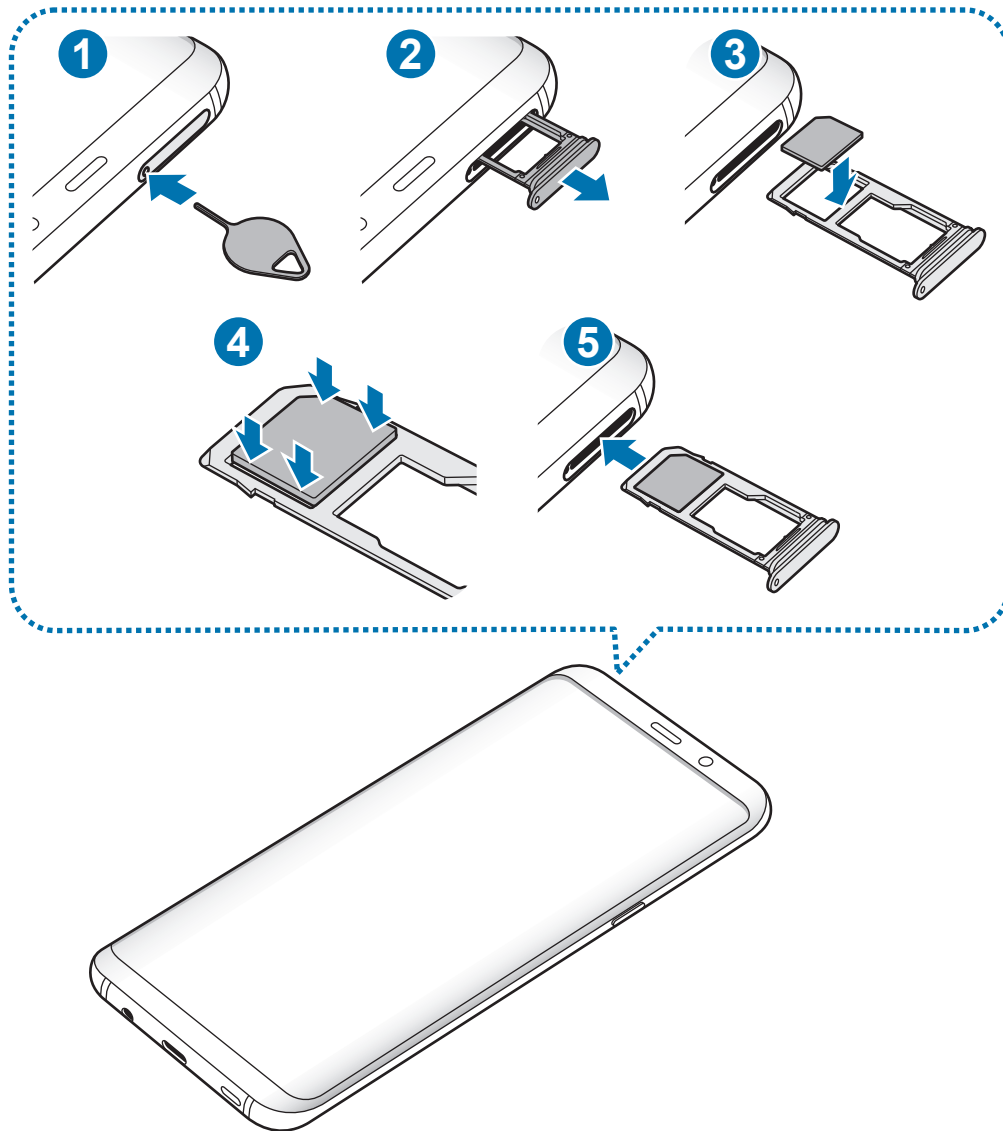

1 Insert the ejection pin into the hole on the tray to loosen the tray.

 Ensure that the ejection pin is perpendicular to the hole. Otherwise, the device may be damaged.

2 Pull out the tray gently from the tray slot.

3 Place the SIM or USIM card on the tray 1 with the gold-coloured contacts facing downwards.

4 Gently press the SIM or USIM card into the tray to secure it.

 If the card is not fixed firmly into the tray, the SIM card may leave or fall out of the tray.

5 Insert the tray back into the tray slot.



- If you insert the tray into your device while the tray is wet, your device may be damaged. Always make sure the tray is dry.
- Fully insert the tray into the tray slot to prevent liquid from entering your device.

## Correct card installation

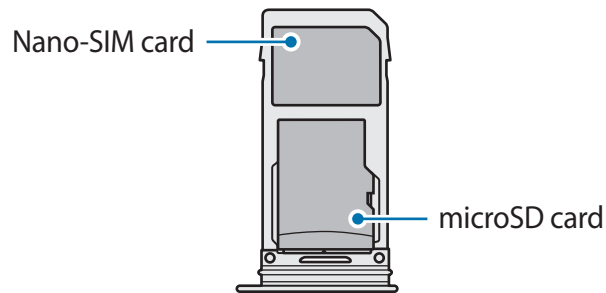

- Use only a nano-SIM card.

## Removing the SIM or USIM card

- 1 Insert the ejection pin into the hole on the tray to loosen the tray.
- 2 Pull out the tray gently from the tray slot.
- 3 Remove the SIM or USIM card.
- 4 Insert the tray back into the tray slot.

## Memory card (microSD card)

### Installing a memory card

Your device's memory card capacity may vary from other models and some memory cards may not be compatible with your device, depending on the memory card manufacturer and type. To view your device's maximum memory card capacity, refer to the Samsung website.



- Some memory cards may not be fully compatible with the device. Using an incompatible card may damage the device or the memory card, or corrupt the data stored in it.
- Use caution to insert the memory card right-side up.



- The device supports the FAT and the exFAT file systems for memory cards. When inserting a card formatted in a different file system, the device will ask to reformat the card or will not recognize the card. To use the memory card, you must format it. If your device cannot format or recognize the memory card, contact the memory card manufacturer or a Samsung Service Centre.
- Frequent writing and erasing of data shortens the lifespan of memory cards.
- When inserting a memory card into the device, the memory card's file directory appears in the **My Files** → **SD card** folder.



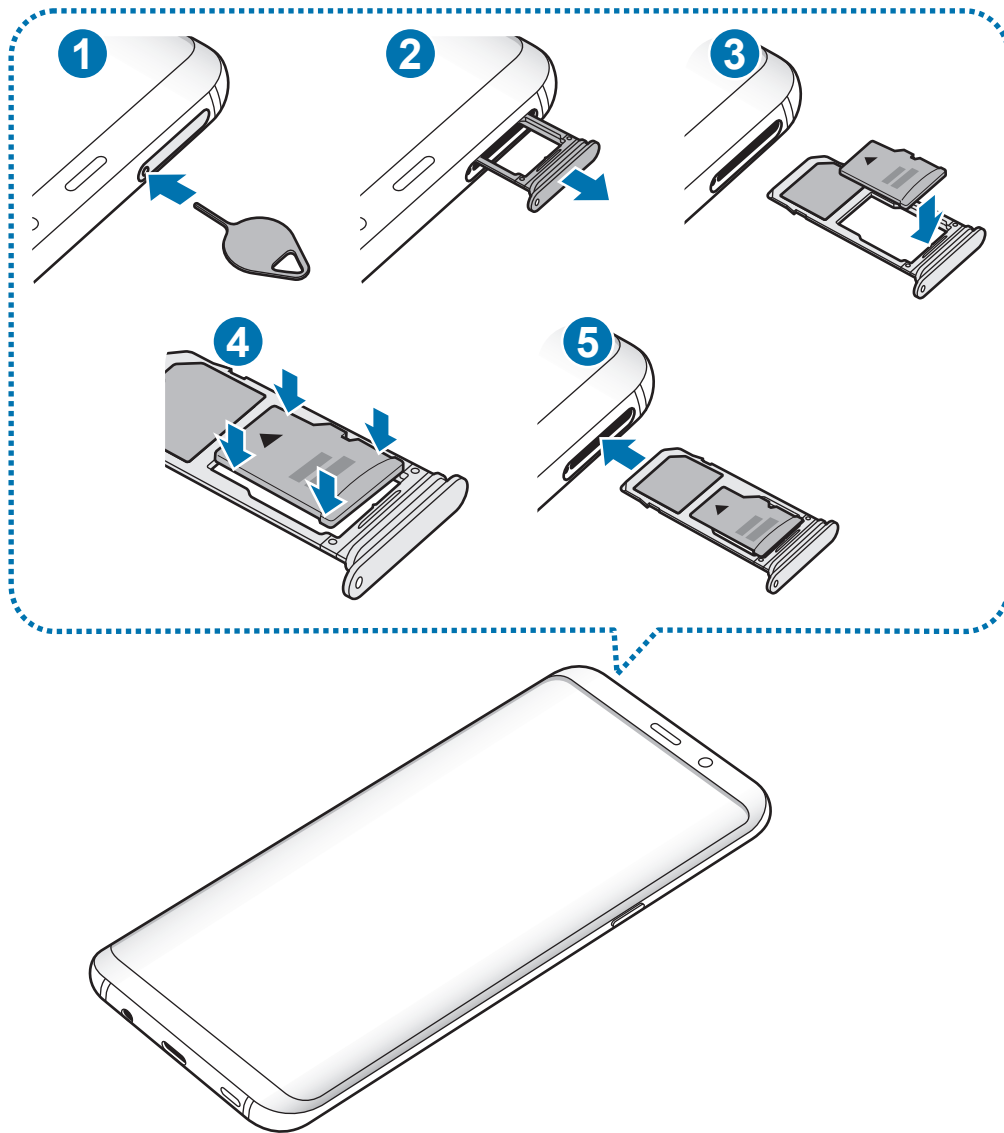

**1** Insert the ejection pin into the hole on the tray to loosen the tray.

**!** Ensure that the ejection pin is perpendicular to the hole. Otherwise, the device may be damaged.

**2** Pull out the tray gently from the tray slot.

**!** When you remove the tray from the device, the mobile data connection will be disabled.

- 3 Place a memory card on the tray 2 with the gold-coloured contacts facing downwards.

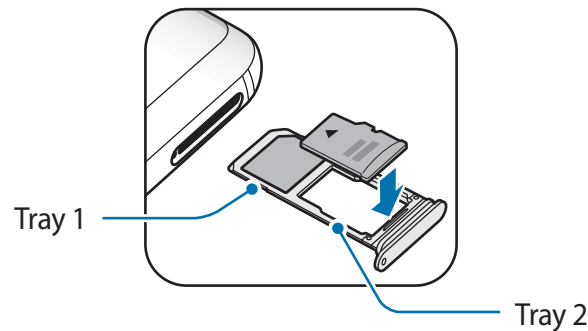

- 4 Gently press the memory card into the tray to secure it.

 If the card is not fixed firmly into the tray, the memory card may leave or fall out of the tray.

- 5 Insert the tray back into the tray slot.

-  • If you insert the tray into your device while the tray is wet, your device may be damaged. Always make sure the tray is dry.
- Fully insert the tray into the tray slot to prevent liquid from entering your device.

## Removing the memory card

Before removing the memory card, first unmount it for safe removal.

Launch the **Settings** app and tap **Device maintenance** → **Storage** →  → **Storage settings** → **SD card** → **UNMOUNT**.

- 1 Insert the ejection pin into the hole on the tray to loosen the tray.

- 2 Pull out the tray gently from the tray slot.

3 Remove the memory card.

4 Insert the tray back into the tray slot.



Do not remove external storage, such as a memory card or USB storage, while the device is transferring or accessing information, or right after transferring data. Doing so can cause data to be corrupted or lost or cause damage to the external storage or device. Samsung is not responsible for losses, including loss of data, resulting from the misuse of external storage devices.

## Formatting the memory card

A memory card formatted on a computer may not be compatible with the device. Format the memory card on the device.

Launch the **Settings** app and tap **Device maintenance** → **Storage** →  → **Storage settings** → **SD card** → **Format**.



Before formatting the memory card, remember to make backup copies of all important data stored in the memory card. The manufacturer's warranty does not cover loss of data resulting from user actions.

## Turning the device on and off

Press and hold the Power key for a few seconds to turn on the device.

When you turn on your device for the first time or after performing a data reset, follow the on-screen instructions to set up your device.

To turn off the device, press and hold the Power key, and then tap **Power off**.



Follow all posted warnings and directions from authorized personnel in areas where the use of wireless devices is restricted, such as airplanes and hospitals.

## Restarting the device

If your device is frozen and unresponsive, press and hold the Power key and the Volume Down key simultaneously for more than 7 seconds to restart it.

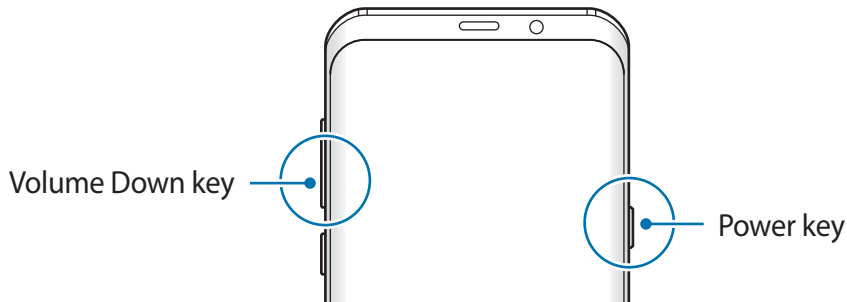

## Emergency mode

You can switch the device to emergency mode to reduce battery consumption. Some apps and functions will be restricted. In emergency mode, you can make an emergency call, send your current location information to others, sound an emergency alarm, and more.

### Activating emergency mode

To activate emergency mode, press and hold the Power key, and then tap **Emergency mode**.



The usage time left shows the time remaining before the battery power runs out. Usage time left may vary depending on your device settings and operating conditions.

### Deactivating emergency mode

To deactivate emergency mode, tap **Turn off Emergency mode**. Alternatively, press and hold the Power key, and then tap **Emergency mode**.

## Initial setup

When you turn on your device for the first time or after performing a data reset, follow the on-screen instructions to set up your device.



- The initial setup procedures may vary depending on the device's software and your region.
- You can set up your device with Bixby Voice depending on the selected device language.

1 Turn on the device.

2 Select your preferred device language and select (→).

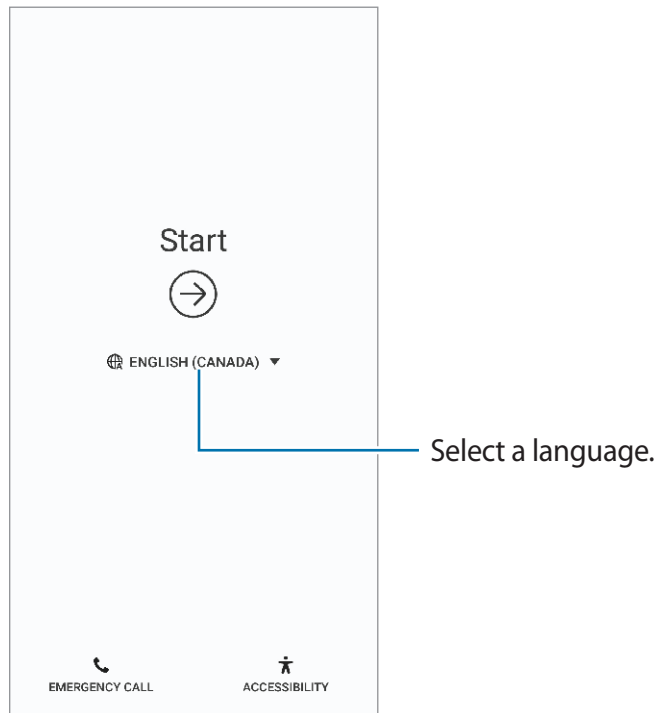

3 Select a Wi-Fi network and connect to it.



If you do not connect to a Wi-Fi network, you may not be able to set up some device features during the initial setup.

4 Follow the on-screen instructions to complete the initial setup.

5 Set a screen lock method to protect your device. You can protect your personal information by preventing others from accessing your device. To set the screen lock method later, tap **No, thank you**.

- 6 Sign in to your Samsung account. You can enjoy Samsung services and keep your data up to date and secure across all of your devices. Refer to [Samsung account](#) for more information.

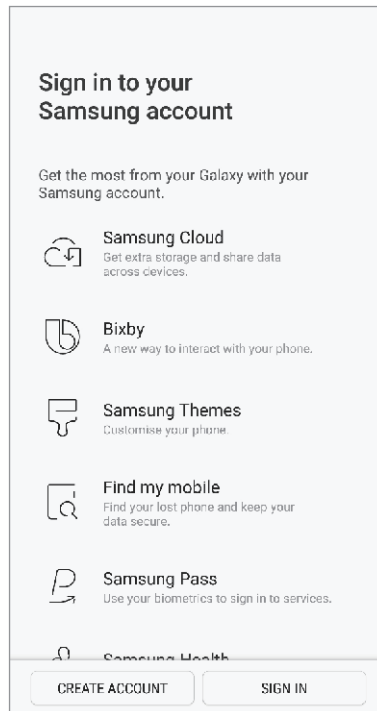

- 7 Get your content from Samsung Cloud or a previous device. Refer to [Transferring data from your previous device](#) for more information.



- 8 Select features you want to use and complete the initial setup. The Home screen will appear.

# Samsung account

## Introduction

Your Samsung account is an integrated account service that allows you to use a variety of Samsung services provided by mobile devices, TVs, and the Samsung website. Once your Samsung account has been registered, you can keep your data up to date and secure across your Samsung devices with Samsung Cloud, track and control your lost or stolen device, see tips and tricks from Samsung Members, and more.

Create your Samsung account with your email address.

To check the list of services that can be used with your Samsung account, visit [account.samsung.com](https://account.samsung.com). For more information on Samsung accounts, launch the **Settings** app and tap **Cloud and accounts** → **Accounts** → **Samsung account** →  → **Help**.

## Registering your Samsung account

### Registering a new Samsung account

If you do not have a Samsung account, you should create one.

- 1 Launch the **Settings** app and tap **Cloud and accounts** → **Accounts** → **Add account**.
- 2 Tap **Samsung account** → **CREATE ACCOUNT**.
- 3 Follow the on-screen instructions to complete creating your account.

### Registering an existing Samsung account

If you already have a Samsung account, register it to the device.

- 1 Launch the **Settings** app and tap **Cloud and accounts** → **Accounts** → **Add account**.
- 2 Tap **Samsung account** → **SIGN IN**.



**3** Enter your email address and password, and then tap **SIGN IN**.

If you forget your account information, tap **Find ID** or **Reset password**. You can find your account information when you enter the required information.

If you want to verify your Samsung account password via your biometric data, such as fingerprints or irises, tap **Verify your identity with biometrics instead of password using Samsung Pass**. Refer to [Samsung Pass](#) for more information.

**4** Read and agree to the terms and conditions and tap **AGREE**.

**5** Tap **DONE** to finish registering your Samsung account.

## Removing your Samsung account

When you remove your registered Samsung account from the device, your data, such as contacts or events, will also be removed.

**1** Launch the **Settings** app and tap **Cloud and accounts** → **Accounts**.

**2** Tap **Samsung account** →  → **Remove account**.

**3** Tap **REMOVE**, enter your Samsung account password, and then tap **REMOVE ACCOUNT**.

## Transferring data from your previous device

You can restore your data, such as images, contacts, messages, and apps from Samsung Cloud. You can also copy them from your previous device via Smart Switch.



- This feature may not be supported on some devices or computers.
- Limitations apply. Visit [www.samsung.com/smartswitch](http://www.samsung.com/smartswitch) for details. Samsung takes copyright seriously. Only transfer content that you own or have the right to transfer.

The following content is about the data restoration features available during the initial setup procedures. For more information about Samsung Cloud or Smart Switch, refer to [Samsung Cloud](#) or [Smart Switch](#).



### Restoring data from your previous device (Smart Switch)

You can connect your previous device to your device with a USB connector (USB Type-C) and a USB cable to easily and quickly transfer data.

- 1 During the initial setup, when the data restoration screen appears, tap **From your old device** → **NEXT**.
- 2 Plug the USB connector (USB Type-C) into the multipurpose jack of your device.

- 3 Connect your device and the previous device using the previous device's USB cable.

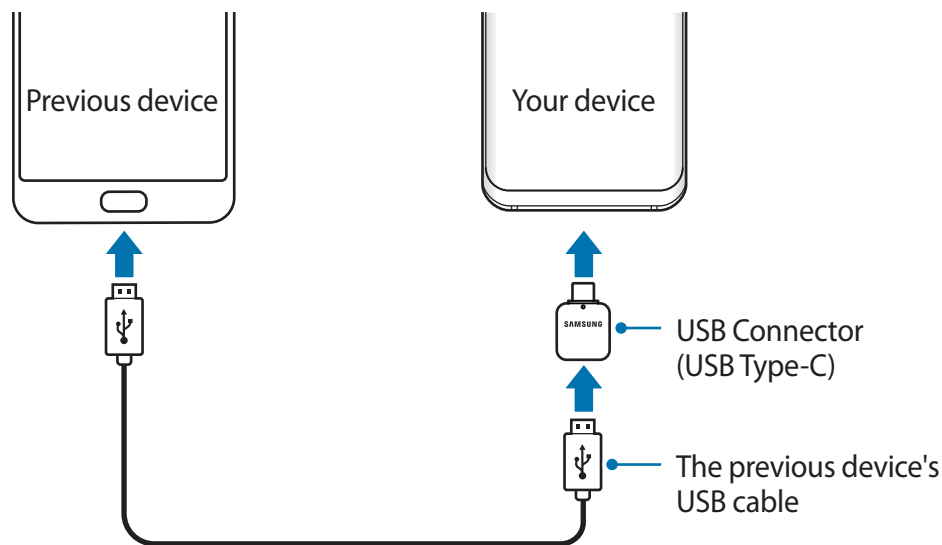

- 4 In the previous device, tap **ALLOW**.

- 5 Follow the on-screen instructions to transfer data from the previous device.

 Do not disconnect the USB cable or USB connector (USB Type-C) from the device when you are transferring files. Doing so may cause data loss or device damage.

 Transferring data increases the battery power consumption of your device. Ensure that your device is sufficiently charged before transferring data. If the battery power is low, data transfer may be interrupted.

## Restoring data from Samsung Cloud

You can restore data you backed up from your previous device to Samsung Cloud.

- 1 During the initial setup, when the data restoration screen appears, tap **From Samsung Cloud** → **NEXT**.
- 2 Tap ▼ under **BACKUP DEVICE** and select your previous device.
- 3 Tick the data types you want to restore and tap **RESTORE**.

# Understanding the screen

## Controlling the touchscreen



- Do not allow the touchscreen to come into contact with other electrical devices. Electrostatic discharges can cause the touchscreen to malfunction.
- To avoid damaging the touchscreen, do not tap it with anything sharp or apply excessive pressure to it with your fingertips.
- Leaving the touchscreen idle for extended periods may result in afterimages (screen burn-in) or ghosting. Turn off the touchscreen when you do not use the device.



- The device may not recognize touch inputs close to the edges of the screen, which are outside of the touch input area.
- It is recommended to use fingers when you use the touchscreen.

### Tapping

Tap the screen.

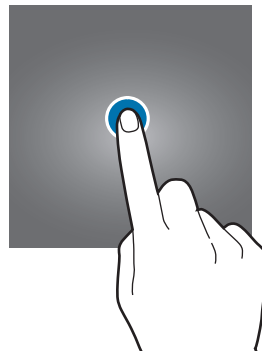

### Tapping and holding

Tap and hold the screen for approximately 2 seconds.

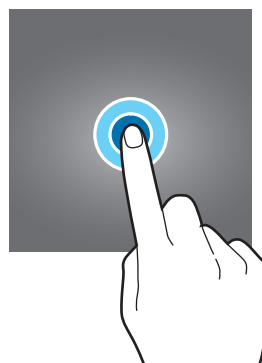

## Dragging

Tap and hold an item and drag it to the target position.

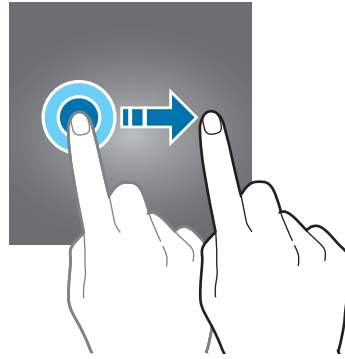

## Double-tapping

Double-tap the screen.



## Swiping

Swipe upwards, downwards, to the left, or to the right.

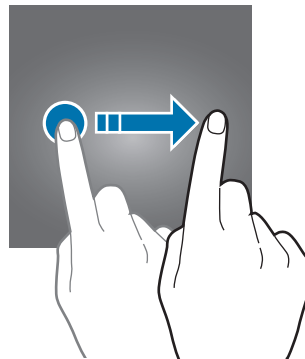

## Spreading and pinching

Spread two fingers apart or pinch on the screen.

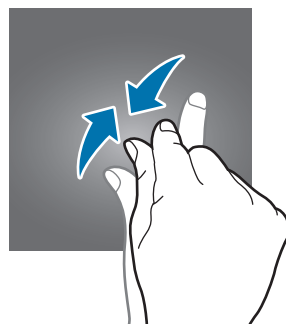
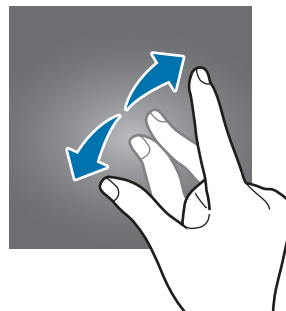

## Navigation bar (soft buttons)

When you turn on the device, the soft buttons will appear on the navigation bar at the bottom of the screen. The soft buttons are set to the Recents button, Home button, and Back button by default. The functions of the buttons can change according to the app currently being used or usage environment.

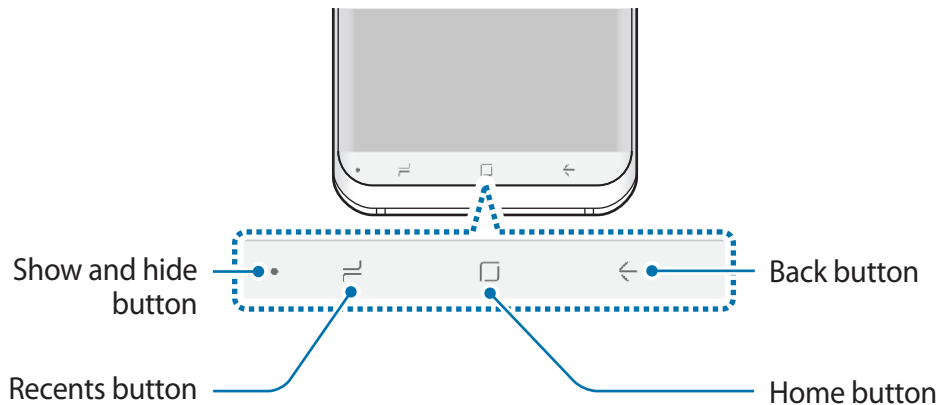

| Button | Function   |
|--------|--|
| ●      | <b>Show and hide</b> <ul style="list-style-type: none"> <li>• Double-tap to pin or hide the navigation bar.</li> </ul>   |
| ⌋      | <b>Recents</b> <ul style="list-style-type: none"> <li>• Tap to open the list of recent apps.</li> </ul>  |
| □      | <b>Home</b> <ul style="list-style-type: none"> <li>• Tap to return to the Home screen.</li> <li>• Tap and hold to launch the <b>Google Assistant</b> app.</li> </ul> |
| ←      | <b>Back</b> <ul style="list-style-type: none"> <li>• Tap to return to the previous screen.</li> </ul>  |

### Displaying or hiding the navigation bar

Using the Show and hide button at the left side of the navigation bar, you can set the navigation bar to be hidden or pinned on the screen when you use apps or features. The navigation bar is pinned by default.

If you want to view files or use apps in full screen, double-tap the Show and hide button to hide the navigation bar.

To show the navigation bar again, drag upwards from the bottom of the screen.



- On certain screens, such as the Home screen, the navigation bar will always be displayed and the Show and hide button will not appear.
- Even after you pin the navigation bar, it can be hidden while using some apps or features, such as a video player.

## Turning on the screen using the Home button

Hard press the Home button or the Home button area to turn on the screen.

On the Always On Display, you can also turn on the screen by double-tapping the Home button.

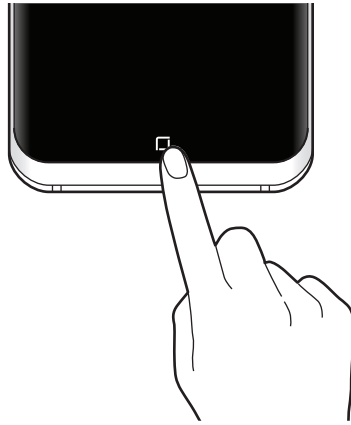

## Setting the navigation bar

Launch the **Settings** app, tap **Display** → **Navigation bar**, and then select an option.

- **Show and hide button:** Add a button to hide or pin the navigation bar. You can set whether or not to display the button for each app.
- **BACKGROUND COLOUR:** Change the navigation bar's background colour.
- **Hard press Home button:** Set the device to return to the Home screen when you hard press the Home button. You can also adjust the amount of pressure needed to use the Home button when hard pressing it.
- **Unlock with Home button:** Set the device to unlock the screen without swiping on the locked screen when you hard press the Home button. This feature is available when **Hard press Home button** is activated.
- **Button layout:** Change the order of the buttons on the navigation bar.

## Home screen and Apps screen

The Home screen is the starting point for accessing all of the device's features. It displays widgets, shortcuts to apps, and more.

The Apps screen displays icons for all apps, including newly installed apps.



The screen may appear differently depending on the region or service provider.

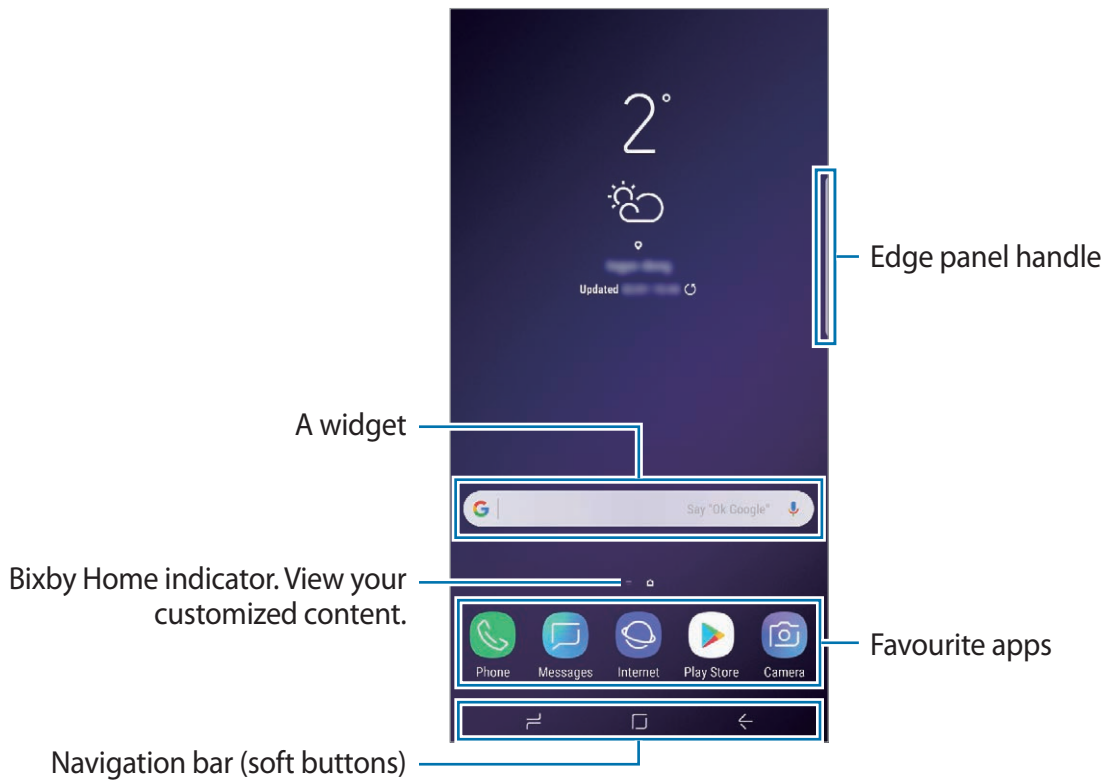



## Switching between Home and Apps screens

On the Home screen, swipe upwards or downwards to open the Apps screen.

To return to the Home screen, swipe upwards or downwards on the Apps screen. Alternatively, tap the Home button or the Back button.



If you add the Apps button on the Home screen, you can open the Apps screen by tapping the button. On the Home screen, tap and hold an empty area and tap **Home screen settings** → **Apps button** → **Show Apps button** → **APPLY**. The Apps button will be added at the bottom of the Home screen.

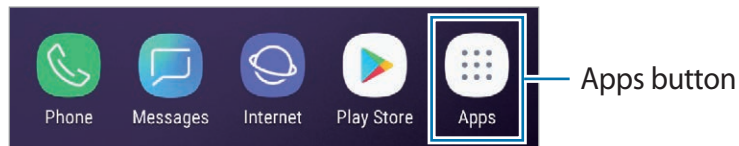

## Display the screen in landscape mode

On the Home screen, tap and hold an empty area, tap **Home screen settings**, and then tap the **Portrait mode only** switch to deactivate it.

Rotate the device until it is horizontal to view the screen in landscape mode.

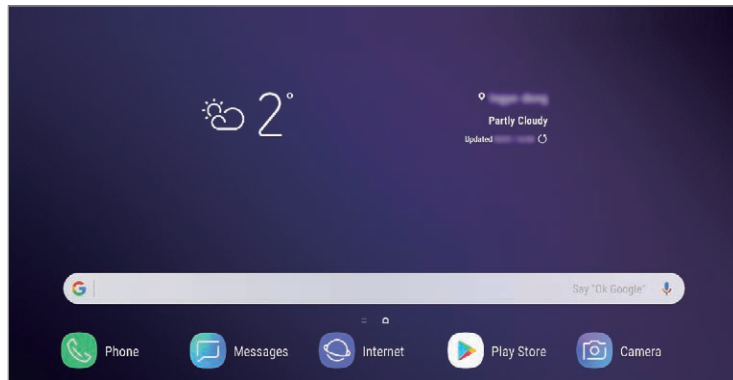

## Moving items

Tap and hold an item, and then drag it to a new location. To move the item to another panel, drag it to the side of the screen.

To add a shortcut to an app on the Home screen, tap and hold an item on the Apps screen, and then drag it to the top of the screen. A shortcut to the app will be added on the Home screen.

You can also move frequently used apps to the shortcuts area at the bottom of the Home screen.

## Creating folders

Create folders and gather similar apps to quickly access and launch apps.

1 On the Home screen or the Apps screen, tap and hold an app, and then drag it over another app.

2 Drop the app when a folder frame appears around the apps.

A new folder containing the selected apps will be created. Tap **Enter folder name** and enter a folder name.

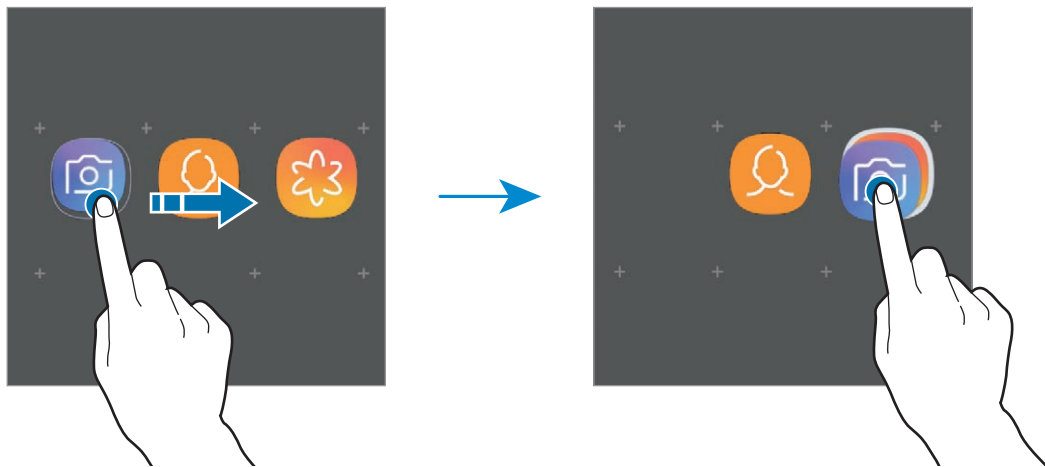

- **Adding more apps**

Tap **ADD APPS** on the folder. Tick the apps to add and tap **ADD**. You can also add an app by dragging it to the folder.

- **Moving apps from a folder**

Tap and hold an app to drag it to a new location.

- **Deleting a folder**

Tap and hold a folder, and then tap **Delete folder**. Only the folder will be deleted. The folder's apps will be relocated to the Apps screen.

## Editing the Home screen

On the Home screen, tap and hold an empty area, or pinch your fingers together to access the editing options. You can set the wallpaper, add widgets, and more. You can also add, delete, or rearrange Home screen panels.

- Adding panels: Swipe to the left, and then tap +.
- Moving panels: Tap and hold a panel preview, and then drag it to a new location.
- Deleting panels: Tap 🗑️ on the panel.



- **Wallpapers:** Change the wallpaper settings for the Home screen and the locked screen.
- **Themes:** Change the device's theme. Visual elements of the interface, such as colours, icons, and wallpapers, will change depending on the selected theme.
- **Widgets:** Widgets are small apps that launch specific app functions to provide information and convenient access on your Home screen. Tap and hold a widget, and then drag it to the Home screen. The widget will be added on the Home screen.
- **Home screen settings:** Change the size of the grid to display more or fewer items on the Home screen and more.

## Displaying all apps on the Home screen

Without using a separate Apps screen, you can set the device to display all apps on the Home screen. On the Home screen, tap and hold an empty area, and then tap

**Home screen settings** → **Home screen layout** → **Home screen only** → **APPLY**.

You can now access all your apps by swiping to the left on the Home screen.



## Indicator icons

Indicator icons appear on the status bar at the top of the screen. The icons listed in the table below are most common.



The status bar may not appear at the top of the screen in some apps. To display the status bar, drag down from the top of the screen.

| Icon | Meaning                                    |
|------|--|
|      | No signal                                  |
|      | Signal strength                            |
|      | Roaming (outside of normal service area)   |
|      | GPRS network connected                     |
|      | EDGE network connected                     |
|      | UMTS network connected                     |
|      | HSDPA network connected                    |
|      | HSPA+ network connected                    |
|      | LTE network connected (LTE-enabled models) |
|      | Wi-Fi connected                            |
|      | Bluetooth feature activated                |
|      | Location services being used               |
|      | Call in progress                           |
|      | Missed call                                |
|      | New text or multimedia message             |
|      | Alarm activated                            |
|      | Mute mode activated                        |
|      | Vibration mode activated                   |
|      | Flight mode activated                      |

| Icon  | Meaning                            |
|---|------------------------------------|
|  | Error occurred or caution required |
|  | Battery charging                   |
|  | Battery power level                |

## Lock screen

Pressing the Power key turns off the screen and locks it. Also, the screen turns off and automatically locks if the device is not used for a specified period.

To unlock the screen, swipe in any direction when the screen turns on.

If the screen is off, press the Power key or hard press the Home button or the Home button area to turn on the screen.



Locked screen

## Changing the screen lock method

To change the screen lock method, launch the **Settings** app, tap **Lock screen and security** → **Screen lock type**, and then select a method.

When you set a pattern, PIN, password, face, iris, or fingerprint for the screen lock method, you can protect your personal information by preventing others from accessing your device. After setting the screen lock method, the device will require an unlock code whenever unlocking it.

- **Swipe:** Swipe in any direction on the screen to unlock it.
- **Pattern:** Draw a pattern with four or more dots to unlock the screen.
- **PIN:** Enter a PIN with at least four numbers to unlock the screen.
- **Password:** Enter a password with at least four characters, numbers, or symbols to unlock the screen.
- **None:** Do not set a screen lock method.
- **Intelligent Scan:** Register both your face and irises to the device to unlock the screen more conveniently. Refer to [Intelligent Scan](#) for more information.
- **Face:** Register your face to unlock the screen. Refer to [Face recognition](#) for more information.
- **Iris:** Register your irises to unlock the screen. Refer to [Iris recognition](#) for more information.
- **Fingerprints:** Register your fingerprints to unlock the screen. Refer to [Fingerprint recognition](#) for more information.



You can set your device to perform a factory data reset if you enter the unlock code incorrectly several times in a row and reach the attempt limit. Launch the **Settings** app, tap **Lock screen and security** → **Secure lock settings**, unlock the screen using the preset screen lock method, and then tap the **Auto factory reset** switch to activate it.

## Screen capture

Capture a screenshot while using the device and write on, draw on, crop, or share the captured screen. You can capture the current screen and scrollable area.

### Capturing a screenshot

Use the following methods to capture a screenshot. Captured screenshots will be saved in **Gallery**.

- **Key capture:** Press and hold the Volume Down key and the Power key simultaneously.
- **Swipe capture:** Swipe your hand to the left or right across the screen.



- It is not possible to capture a screenshot while using some apps and features.
- If capturing a screenshot by swiping is not activated, launch the **Settings** app, tap **Advanced features**, and then tap the **Palm swipe to capture** switch to activate it.

After capturing a screenshot, use the following options on the toolbar at the bottom of the screen:

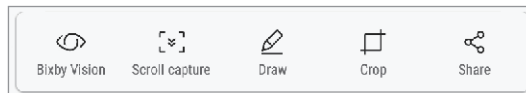

**Bixby Vision:** Recognize content using Bixby Vision and search for relevant information.

- **Scroll capture:** Capture the current content and the hidden content on an elongated page, such as a webpage. When you tap **Scroll capture**, the screen will automatically scroll down and more content will be captured.
- **Draw:** Write or draw on the screenshot.
- **Crop:** Crop a portion from the screenshot. The cropped area will be saved in **Gallery**.
- **Share:** Share the screenshot with others.



If the options are not visible on the captured screen, launch the **Settings** app, tap **Advanced features**, and then tap the **Smart capture** switch to activate it.



# Notification panel

When you receive new notifications, such as messages or missed calls, indicator icons appear on the status bar. To see more information about the icons, open the notification panel and view the details.

To open the notification panel, drag the status bar downwards. To close the notification panel, swipe upwards on the screen.

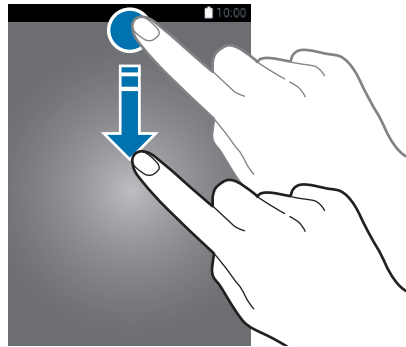

You can open the notification panel, even on the locked screen.

You can use the following functions on the notification panel.

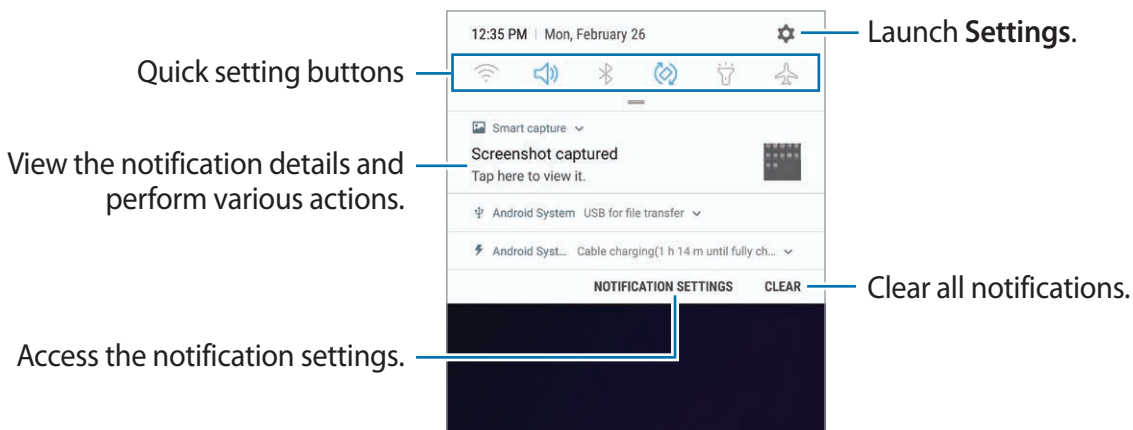

## Using quick setting buttons

Tap quick setting buttons to activate certain features. Swipe downwards on the notification panel to view more buttons.

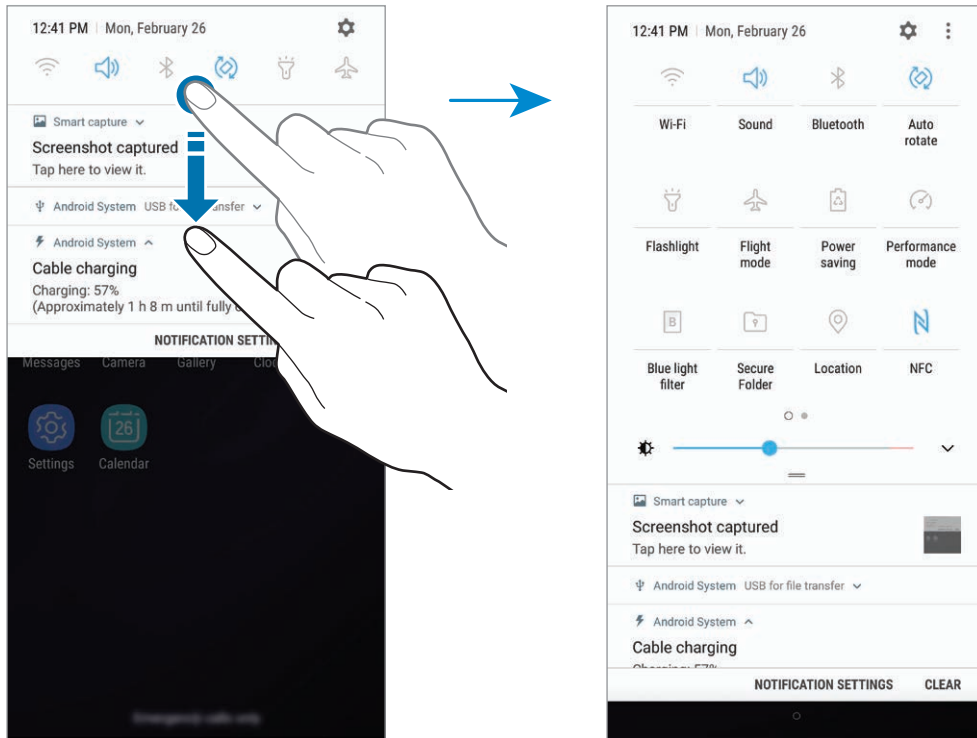

To change feature settings, tap the text under each button. To view more detailed settings, tap and hold a button.

To rearrange buttons, tap  → **Button order**, tap and hold a button, and then drag it to another location.

# Entering text

## Keyboard layout

A keyboard appears automatically when you enter text to send messages, create notes, and more.



- When the keyboard is opened for the first time, the keyboard setup screen will appear. Set the input language, keyboard type, and keyboard settings and then tap **START**.
- Text entry is not supported in some languages. To enter text, you must change the input language to one of the supported languages.

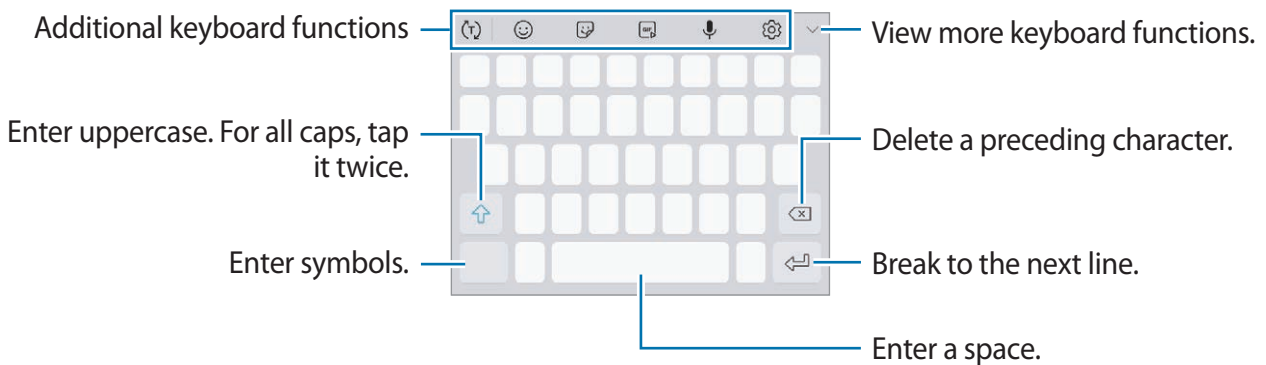

## Changing the input language

Tap  → **Languages and types** → **MANAGE INPUT LANGUAGES**, and then select the languages to use. When you select two or more languages, you can switch between the input languages by swiping to the left or right on the space key.





## Changing the keyboard

To change the keyboard type, tap  → **Languages and types**, select a language, and then select the keyboard type you want.









On a **3x4 keyboard**, a key has three or four characters. To enter a character, tap the corresponding key repeatedly until the desired character appears.

## Additional keyboard functions



- : Predict words based on your input and show word suggestions. To return to the keyboard functions list, tap .
- : Enter emoticons.
- : Enter stickers. You can also enter My Emoji stickers that look like you. Refer to [My Emoji](#) for more information.
- : Attach animated GIFs.



This feature may not be available depending on the region or service provider.





- : Enter text by voice.
- : Change the keyboard settings.
-  → : Add an item from the clipboard.
-  → : Change the keyboard for one-handed operation.

## Copying and pasting

- 1 Tap and hold over text.
- 2 Drag  or  to select the desired text, or tap **Select all** to select all text.
- 3 Tap **Copy** or **Cut**.  
The selected text is copied to the clipboard.
- 4 Tap and hold where the text is to be inserted and tap **Paste**.  
To paste text that you have previously copied, tap **Clipboard** and select the text.

## Dictionary

Look up definitions for words while using certain features, such as when browsing webpages.

- 1 Tap and hold over a word that you want to look up.  
If the word you want to look up is not selected, drag  or  to select the desired text.
- 2 Tap **Dictionary** on the options list.  
If a dictionary is not preinstalled on the device, tap **Move to Manage dictionaries** →  next to a dictionary to download it.
- 3 View the definition in the dictionary pop-up window.  
To switch to the full screen view, tap . Tap the definition on the screen to view more definitions. In the detailed view, tap  to add the word to your favourite words list or tap **Search Web** to use the word as a search term.

# Apps and features

## Installing or uninstalling apps

### Galaxy Apps

Purchase and download apps. You can download apps that are specialized for Samsung Galaxy devices.

Open the **Samsung** folder and launch the **Galaxy Apps** app.



This app may not be available depending on the region or service provider.

### Installing apps

Browse apps by category or tap the search field to search for a keyword.

Select an app to view information about it. To download free apps, tap **INSTALL**. To purchase and download apps where charges apply, tap the price and follow the on-screen instructions.



To change the auto update settings, tap  → **Settings** → **Auto update apps**, and then select an option.

### Play Store

Purchase and download apps.

Launch the **Play Store** app.

### Installing apps

Browse apps by category or search for apps by keyword.

Select an app to view information about it. To download free apps, tap **INSTALL**. To purchase and download apps where charges apply, tap the price and follow the on-screen instructions.



To change the auto update settings, tap  → **Settings** → **Auto-update apps**, and then select an option.

## Managing apps

### Uninstalling or disabling apps

Tap and hold an app and select an option.

- **Disable:** Disable selected default apps that cannot be uninstalled from the device.
- **Uninstall:** Uninstall downloaded apps.

### Enabling apps

Launch the **Settings** app, tap **Apps** → ▼ → **Disabled**, select an app, and then tap **ENABLE**.

### Setting app permissions

For some apps to operate properly, they may need permission to access or use information on your device. When you open an app, a pop-up window may appear and request access to certain features or information. Tap **ALLOW** on the pop-up window to grant permissions to the app.

To view your app permission settings, launch the **Settings** app and tap **Apps**. Select an app and tap **Permissions**. You can view the app's permissions list and change its permissions.

To view or change app permission settings by permission category, launch the **Settings** app and tap **Apps** → ⋮ → **App permissions**. Select an item and tap the switches next to apps to grant permissions.



If you do not grant permissions to apps, the basic features of the apps may not function properly.

# Bixby

## Introduction

Bixby is a new interface that can communicate with you and it provides services that help you to use your smartphone more conveniently.

- **Bixby Home:** You can view recommended services and information that Bixby provides by analyzing your usage patterns and your routine.
- **Bixby Voice:** You can use voice commands to request what you want with Bixby Voice.
- **Bixby Vision:** You can easily search for relevant information about objects or locations using the Bixby Vision features.
- **Reminder:** You can create reminders to schedule to-do items or to view content later.



- To use the Bixby feature, your device must be connected to a Wi-Fi or mobile network.
- To use the Bixby feature, you must register and sign in to your Samsung account.



Press the Bixby key to open Bixby Home. To close Bixby Home, press the key again.

Press and hold the Bixby key to launch Bixby Voice immediately. While pressing and holding the Bixby key, say what you want to Bixby Voice and then release your finger from the key. Bixby Voice will perform what you request.

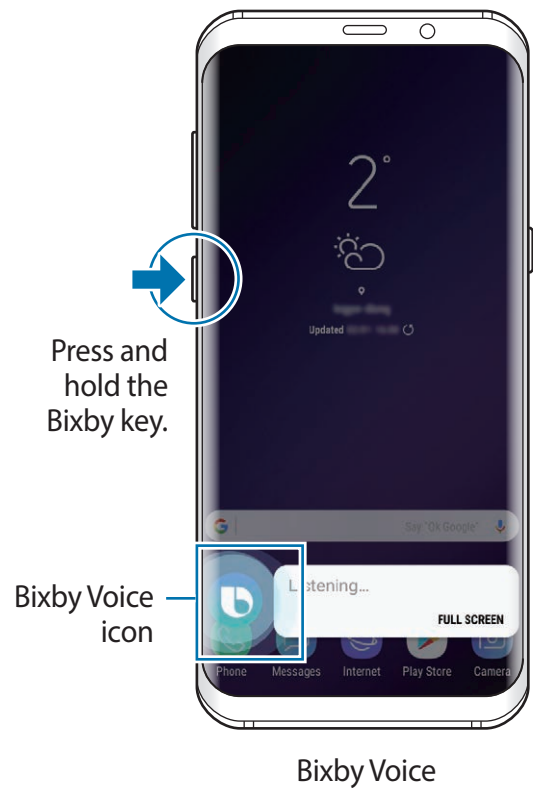
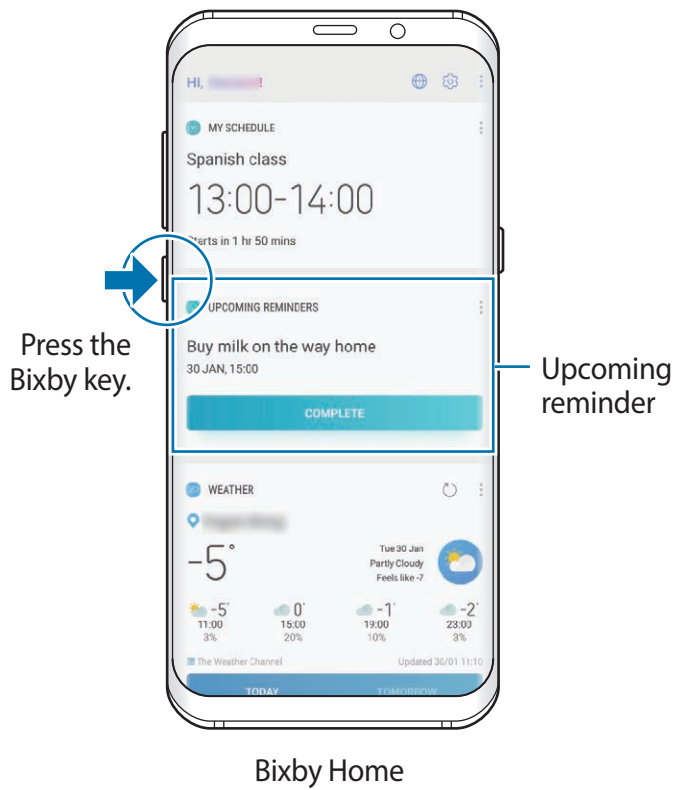

Available Bixby services may differ depending on the region or service provider.

## Starting Bixby

When you launch Bixby for the first time, the Bixby intro page will appear. You must register and sign in to your Samsung account according to the on-screen instructions and agree to the terms and conditions.

- 1 Press the Bixby key.

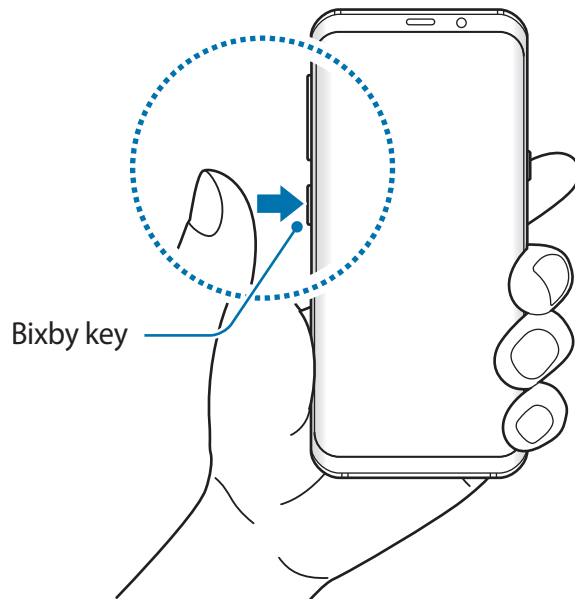

- 2 Check the Bixby intro page and tap **NEXT**.
- 3 Tap **SIGN IN** and follow the on-screen instructions to sign in to your Samsung account.



If you are already signed in, this step will not appear.

- 4 Read and agree to the terms and conditions and tap **NEXT**.
- 5 Select the language to communicate with Bixby Voice and tap **CONFIRM**.
- 6 Follow the on-screen instructions to complete the Bixby Voice setup.

## Bixby Home

On the Bixby Home screen, you can view recommended services and information that Bixby provides by analysing your usage patterns and your routine.

### Opening Bixby Home

1 Press the Bixby key. Alternatively, swipe to the right on the Home screen.  
The Bixby Home screen will appear.

2 Swipe upwards or downwards to view recommended content.

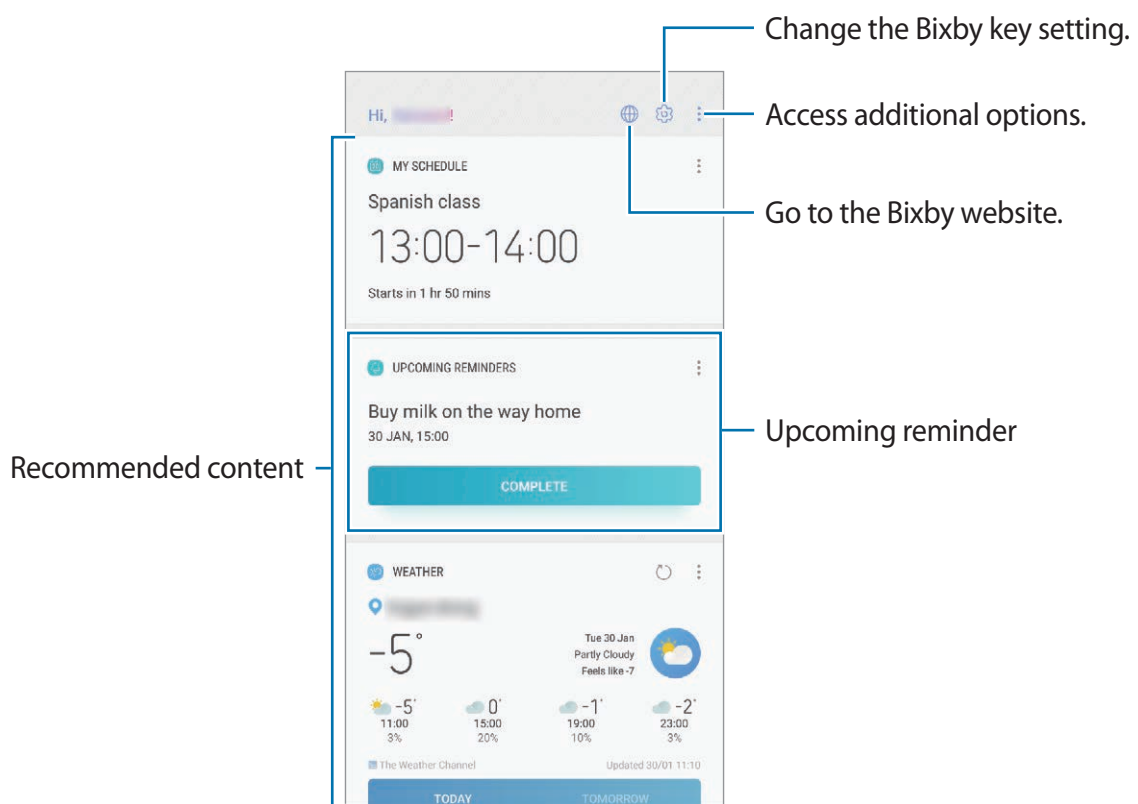

3 To close Bixby Home, press the Bixby key again. Alternatively, swipe to the left on the screen.

## Using recommended content on Bixby Home





When you open Bixby Home, you can view the content that is frequently updated as Bixby cards. Swipe upwards or downwards to view the Bixby cards.

For example, on the way to the office in the morning, you can view your day's schedule and play your favourite music on the Bixby Home screen. In the evening, you can view alarms, check your daily activity, and view your friends' feeds.



The content and order of the cards update automatically at a specified interval. To manually update cards, swipe downwards on the screen.

### Editing Bixby cards list

- To pin a card to the top of the Bixby Home screen, tap  → **Pin to top**. To unpin a card, tap  → **Unpin**.
- To hide a card from the list, tap  → **Hide for now**.
- To stop displaying a card on the list, tap  → **Don't show again**.

### Selecting apps to show as Bixby cards

Add or delete apps to show as cards on the Bixby Home screen.

On the Bixby Home screen, tap  → **Settings** → **Apps** and tap the switches next to items to add or delete them.



If an app is not installed on the device, you must install it to use it. On the Bixby Home screen, tap  → **Settings** → **Apps** and then tap **DOWNLOAD** beside an app to download it.

## Bixby Voice

Bixby Voice is a voice service that helps you use the device more conveniently.

You can talk to Bixby Voice or type text. Bixby Voice will launch a function you request or show the information you want. It also learns your usage patterns and environments. The more it learns about you, the more precisely it will understand you.



- To use Bixby Voice, your device must be connected to a Wi-Fi or mobile network.
- To use Bixby Voice, you must register and sign in to your Samsung account.

## Launching Bixby Voice

### Launching Bixby Voice with the Bixby key

When you press and hold the Bixby key, Bixby Voice will launch and start listening.

While pressing and holding the Bixby key, say what you want to Bixby Voice, and then release your finger from the key.



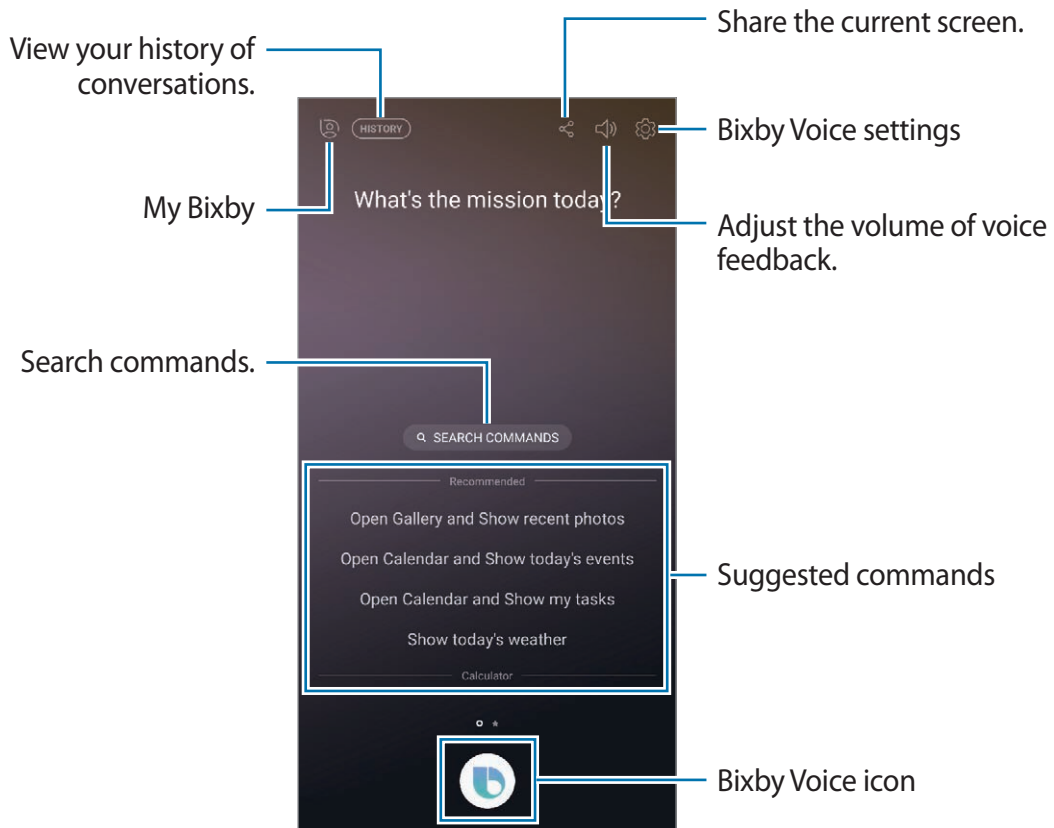

When you tap **FULL SCREEN**, the Bixby Voice full screen will appear. On the Bixby Voice full screen, you can use the following features.



## Launching Bixby Voice using your voice

You can start a conversation without pressing and holding the Bixby button. Register your voice so that Bixby Voice will launch when you say "Hi Bixby".

- 1 On the Bixby Home screen, tap  → **Settings** → **Voice wake-up** and tap the switch to activate it.
- 2 Tap  and follow the on-screen instructions to complete the setup.  
Now you can say "Hi Bixby", and when the device emits a sound, say what you want.

## Using Bixby Voice

When you say what you want to Bixby Voice, Bixby Voice will display your speech as on-screen text and launch corresponding functions or show the information you requested.

For example, if you say "Show me today's weather", then the weather information will appear on the Bixby Voice screen.

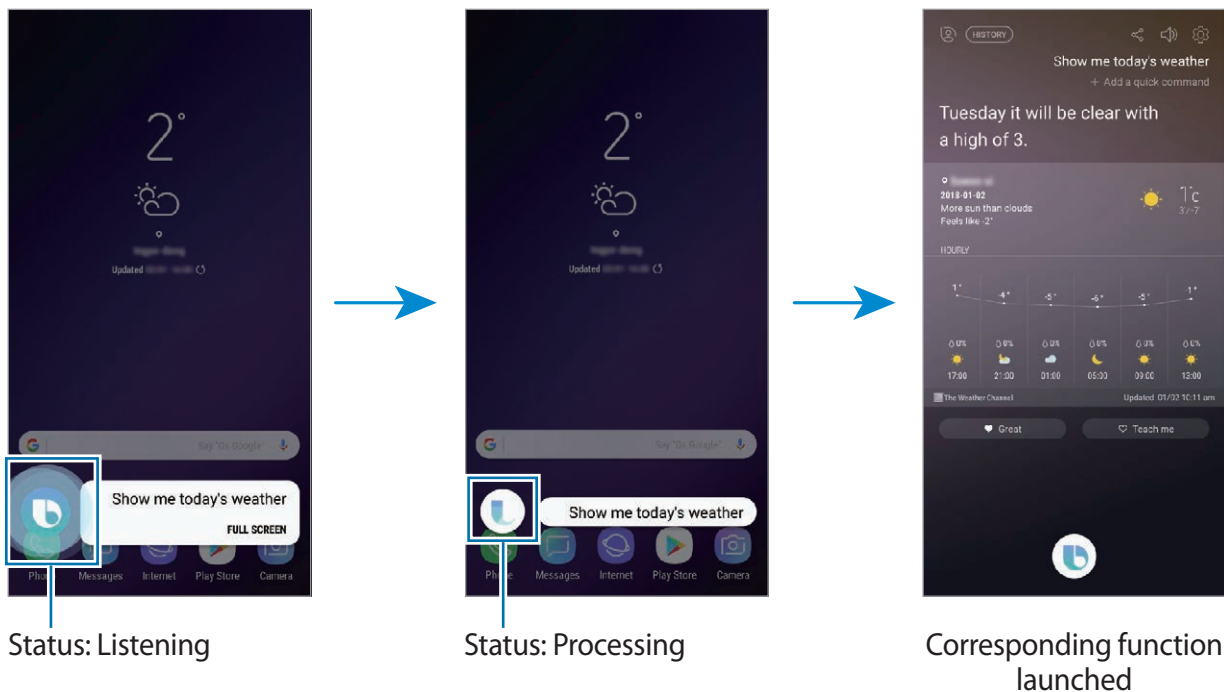

If Bixby Voice is on standby (🔇), it cannot listen to your voice. Tap the standby status icon (🔇) and say your request again when the icon changes to the listening status icon (🗣️).

## Status icons

The Bixby Voice icon will change according to Bixby Voice's current status as follow:



Bixby Voice is listening. Say your request.





Bixby Voice is processing your request.



Bixby Voice is on standby. To talk to Bixby Voice, tap this icon and say your request when the icon changes to the listening status icon.

## Getting follow-up questions

Bixby Voice will ask follow-up questions when they are needed to understand your request.

If you just say "Send text", then Bixby Voice will ask who you want to send a text to. Say the name of the recipient. If Bixby Voice is on standby () , tap  and say the name of the recipient.

## Closing Bixby Voice

To stop using Bixby Voice, tap the Back button.



## Viewing supported apps and commands

To view Bixby Voice supported apps and various ways to use Bixby Voice, open Bixby Home and tap  → **Voice apps and services**. You can view the suggested commands of how to use each app. To use an app, say the suggested command to Bixby Voice.

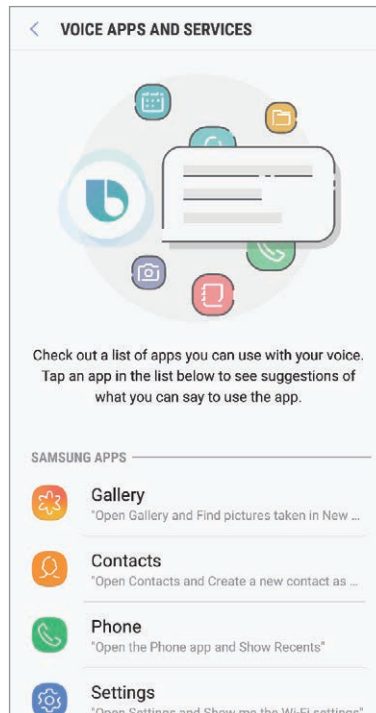

## Deactivating Bixby Voice

You can deactivate Bixby Voice from launching even when you press and hold the Bixby key or say “Hi Bixby”.

On the Bixby Home screen, tap  → **Settings** and tap the **Bixby Voice** switch to deactivate it.

## Bixby Voice usages

### Launching apps or functions

Launch apps or functions quickly using Bixby Voice.

Say your request including the app or feature name to help Bixby Voice execute your request more accurately.

- 1 Press and hold the Bixby key, say “Call mom”, and then release your finger from the Bixby key.
- 2 Bixby will now make a call to the contact saved as mom and you can begin your conversation.

### Browsing the Internet

Say “Search for nearby libraries on the Internet” to Bixby Voice.

The **Internet** app will show the results. Check the results.

### Checking your tasks

Say “Show me my tasks” to Bixby Voice.

The **Calendar** app will launch and it will show your task list.

### Viewing your travel photos

Say “Open Gallery and find photos taken in New York” to Bixby Voice.

The **Gallery** app will launch and it will show you the photos taken in New York.

### Recording voice

Say “Open Voice Recorder and start recording” to Bixby Voice.

The **Voice Recorder** app will launch and it will start recording.

### Viewing your step count records

Say “Show me my step count for today” to Bixby Voice.

The **Samsung Health** app will launch and it will show you the steps tracker.

## Using quick commands

You can add quick commands so that you can say commands more quickly and easily. You can also launch multiple commands together by adding them to a quick command.

### Adding your own quick commands

- 1 On the Bixby Home screen, tap  → **My Bixby** → **Quick commands**.
- 2 Tap **ADD** → **Add quick command**.

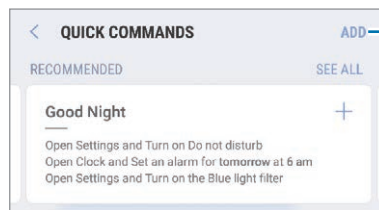

Add your own quick commands.

- 3 Tap , say a quick command to add, and then tap **SAVE**.
- 4 Tap **Add Bixby command** and select **Select from history** or **Search all commands**.
- 5 Select a command that Bixby Voice will perform.

If the command contains information to edit, such as time or a name, you can edit them by tapping .

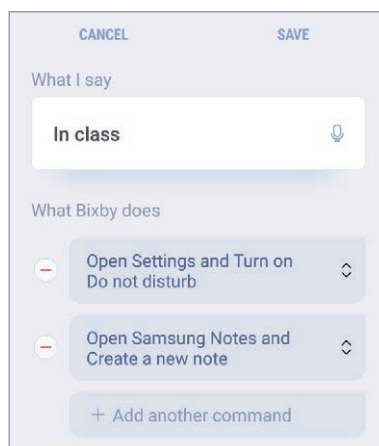

To add additional commands, tap **Add another command**.



- 6 Tap **SAVE**.

## Adding recommended quick commands

You can add recommended quick commands to your quick commands.

On the Bixby Home screen, tap  → **My Bixby** → **Quick commands**. Swipe to the left or right on a recommended quick command and tap  on the command you want.

## Launching commands using quick commands

Press and hold the Bixby key, say a quick command, and then release your finger from the Bixby key.

The commands you set to the quick command will launch.

## Making custom responses

Make your chats with Bixby Voice unique with custom responses.

### Adding custom responses

- 1 On the Bixby Home screen, tap  → **My Bixby** → **Custom chat**.
- 2 Tap **ADD** and enter what you say and what Bixby Voice will answer.

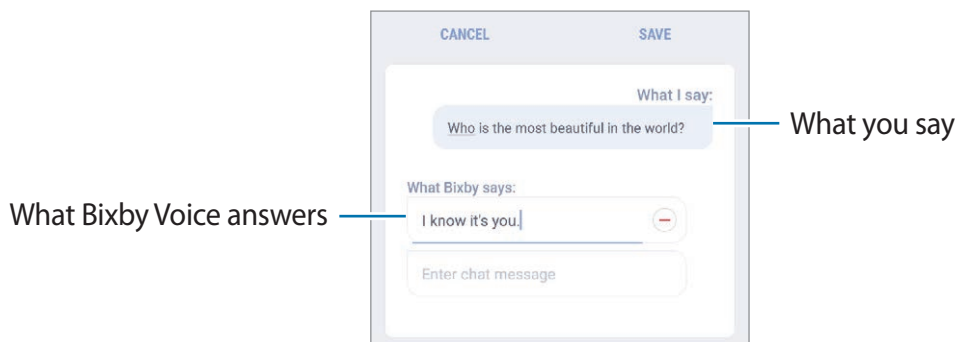

- 3 Tap **SAVE**.

When you say the custom chat line, Bixby Voice will answer with the response you saved.

## Additional Bixby Voice functions

### Checking supported languages

Bixby Voice is only available in some languages, and certain features may not be available depending on your region. To see the list of supported languages, open Bixby Home, and then tap  → **Settings** → **Language and speaking style** → **Languages**.

### Using dictation mode

Use dictation mode when it is hard to type.

In the text input field, press and hold the Bixby key and say “Write down” followed by what you want to enter.

Your spoken words will be converted to on-screen text.



You can also set Bixby Voice to start dictation mode when you press and hold the Bixby key while the Samsung keyboard is open. To use this feature, open the Bixby Home screen, tap  → **Settings**, and then tap the **Dictation on keyboard** switch to activate it.

### Sending feedback to Bixby Voice

To help Bixby Voice understand you better, give feedback to Bixby Voice on what it has done for you.

Tap  when Bixby Voice completes your request.

Tap  when Bixby Voice fails to complete your request or an error occurs..

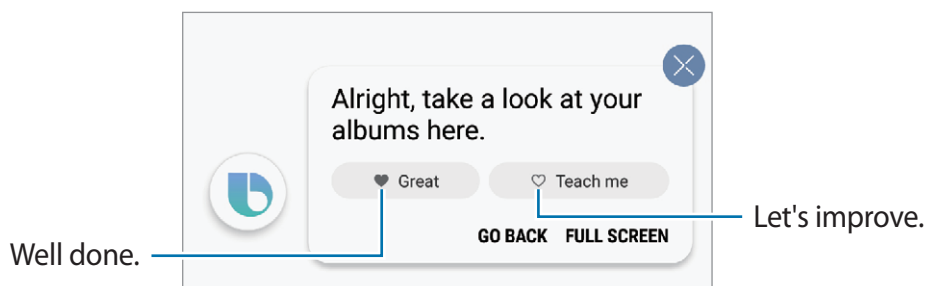



## Unlocking the screen by voice

You can unlock the screen by saying your voice password to Bixby Voice.



- Your device can be unlocked by someone else who says the correct password.
- Voice password is less secure than Pattern, PIN, or Password.

### Setting a voice password

- 1 On the Bixby Home screen, tap  → **Settings** → **Unlock with voice password**.
- 2 Unlock the screen using the preset screen lock method.  
If you have not set a screen lock method, create one.
- 3 Read the on-screen instructions and tap **CONTINUE**.
- 4 Tap  and say your voice password.
- 5 Follow the on-screen instructions to complete the setup.

### Unlocking the screen with your voice password

If you speak to Bixby Voice while the screen is locked, Bixby Voice will ask you to say your voice password. Say your voice password to unlock the screen.

## Waking up Bixby Voice while using the speaker

You can wake up Bixby Voice by saying “Hi Bixby” even when the speaker plays alarms, ringtone, or media.

On the Bixby Home, tap  → **Settings** → **Voice wake-up** and tap the **Use when phone speaker playing** switch to activate it.

## Using earphones or a Bluetooth headset

Connect earphones or a Bluetooth headset to the device when your voice is not heard clearly via the built-in microphone due to noisy environments. Press and hold the Call button on earphones or a Bluetooth headset to launch Bixby Voice and say your request to the microphone.



This feature may not be available or its method of use may vary depending on the earphones and Bluetooth headset.

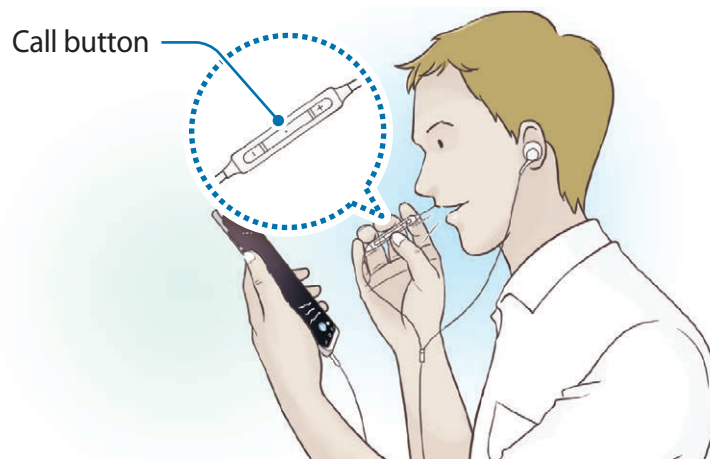

## Bixby Vision

Bixby Vision is a service that provides information, such as similar images, location, translated text, and QR codes. Bixby Vision recognises objects quickly and intuitively even when you do not know its name.



Use the following Bixby Vision features.



- To use this feature, the device must be connected to a Wi-Fi or mobile network.
- To use this feature, you must register and sign in to your Samsung account.
- The available features and search results may vary depending on the region or service provider.
- This feature may not be available or you may not get correct search results depending on the image size, format, or resolution.
- Samsung is not responsible for the product information provided by Bixby Vision.



## Launching Bixby Vision



- 1 Launch Bixby Vision using one of these methods.
  - In the **Camera** app, select the **AUTO** mode and tap .
  - In the **Gallery** app, select an image and tap .
  - In the **Internet** app, tap and hold an image and tap **Bixby Vision**.
  - Capture a screen and select **Bixby Vision** on the toolbar.
  - If you added the Bixby Vision app icon to the Home screen, launch the **Bixby Vision** app.
- 2 Select the feature you want.
- 3 Keep the object within the screen to recognise it.

When the object is recognised, related information will appear on the screen.

## Experiencing virtual makeup

Try various makeup products on your face in real time and search for the products' information. You can find various colours and styles that suit to you.

- 1 Launch the **Camera** app and launch Bixby Vision.

Alternatively, launch the **Bixby Vision** app.
  - 2 Select  and face the front camera lens.
  - 3 Select a makeup product to try on your face.
  - 4 Tap .
- The information about the product will appear.

## Translating or extracting text

Recognize and show the translated text on the screen. You can also extract text from a document or text file.

For example, if you want to know what a sign says while travelling abroad, use the Bixby Vision features. The device will translate the sign's text into the language you select.

- 1 When you have a desired image or object, launch Bixby Vision.

2 Select  and keep the text within the screen to recognize it.

The translated text will appear on the screen.

- To extract text, tap . You can share or save the extracted text.
- To change the source or target language, tap the language settings panel at the top of the screen.

## Searching for similar images

Search for images similar to the recognized object online. You can view various images with properties similar to the object, such as colour or shape.

For example, if you want to know the title of a photo or image, use the Bixby Vision features. The device will search for and show you related information or images with similar characteristics.

1 When you have a desired image or object, launch Bixby Vision.

2 Select  and keep the object within the screen to recognize it.

3 Tap .

The similar images will appear.

## Searching for nearby places

Search for landmarks or information about nearby places by recognizing your current location.

For example, if you want to search for cafes near a landmark, use the Bixby Vision features. The device will search for and show you nearby cafes.

1 When you have a desired landmark or place, launch Bixby Vision.

2 Select  and keep the landmark or place within the screen to recognize it.

You can view basic information about nearby places.

When you move your device, nearby places in the direction where the camera is facing will appear on the screen.



If you are using Bixby Vision with the camera, you can view your current location and weather information. To view your current location on the map, point the camera towards the ground. To view the current weather information, point the camera towards the sky.

### 3 Tap .

The device will show information of nearby places.

## Searching for wine information

Detect the information from a wine label and search for information on the wine.

For example, if you find your favourite wine or want to know more about a wine, use the Bixby Vision features.

1 When you have a desired image or object, launch Bixby Vision.

2 Select  and keep the wine label within the screen to recognize it.

3 Tap .

The information about the wine label will appear.

## Reading QR codes

Recognize QR codes and view a variety of information, such as websites, photos, videos, maps, and business cards.

1 When you have a desired image or object, launch Bixby Vision.

2 Select  and keep the QR code within the screen to recognize it.

The information connected to the QR code will appear.

## Reminder

Create reminders to schedule to-do items or to view content later. You will receive notifications at the preset time or location for each reminder.



- To receive more accurate notifications, connect to a Wi-Fi or mobile network.
- To fully use this feature, you must register and sign in to your Samsung account.
- To use location reminders, the GPS feature must be activated.

## Starting Reminder

You can start Reminder from Bixby Home.

- 1 Press the Bixby key. Alternatively, swipe to the right on the Home screen. The Bixby Home screen will appear.
- 2 Tap **GET STARTED** on the **UPCOMING REMINDERS** card. The Reminder intro page will appear.

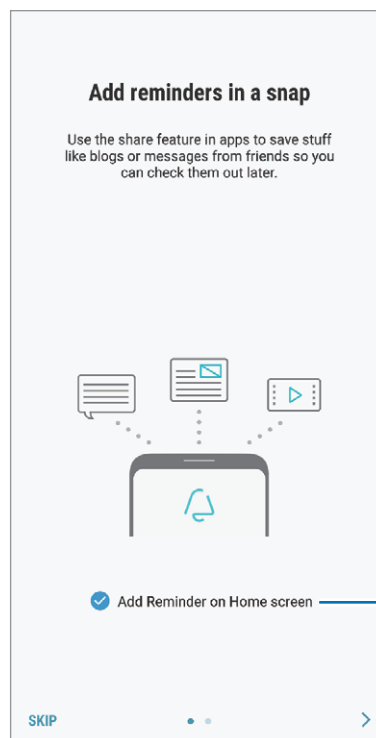
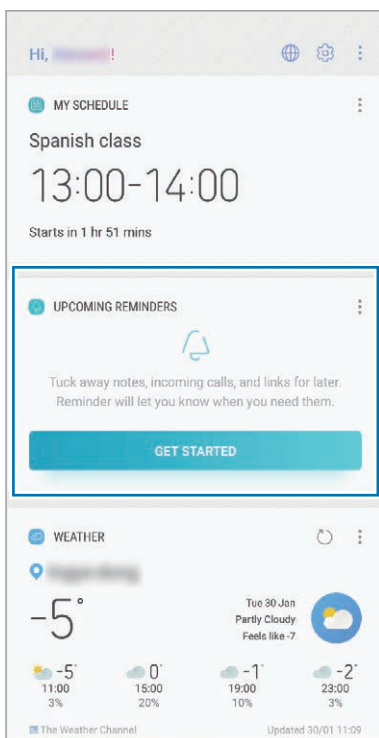

Add the app icon to the Home screen.

### 3 Tap **START**.

If the **Add Reminder on Home screen** option is ticked, you can launch the **Reminder** app (🔔) from the Home screen.

## Creating reminders

Create reminders with various methods. Reminder will alert you if you create a reminder with a specified time or location setting. You can also save various content, such as a single memo or webpage address, and view it later.

For example, create a reminder to alert you to 'Water the flowers when I get home.'

1 Launch the **Reminder** app.

2 Tap **Write a reminder** and enter 'Water the flowers.'

3 Tap **Set conditions** → **Pick a place** and set the location to home.

4 Tap **WHEN I ARRIVE AT** → **DONE**.

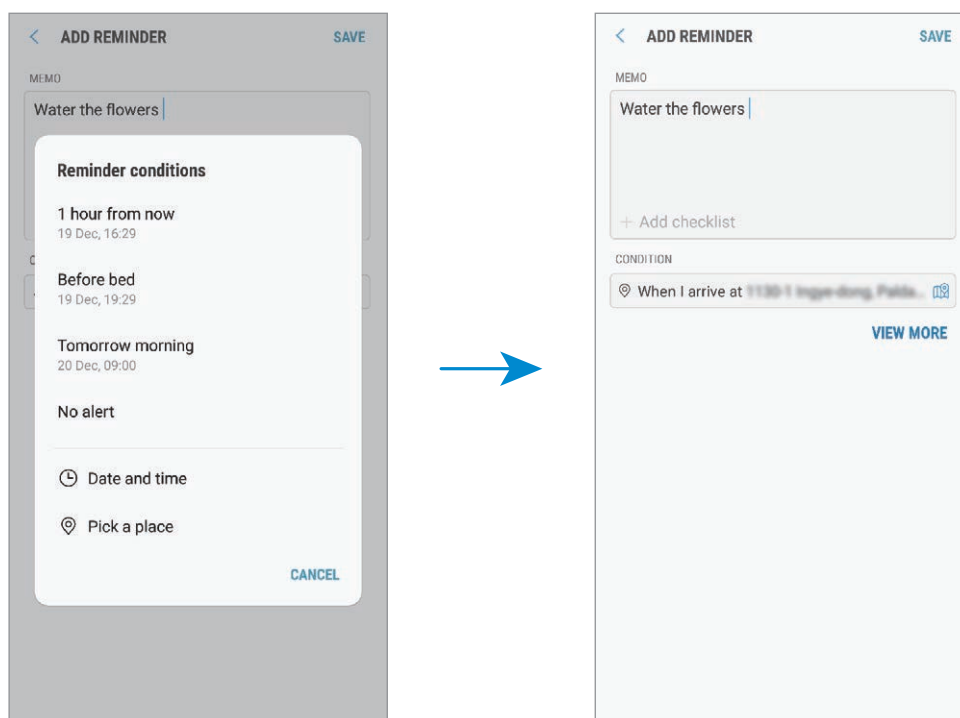

5 Tap **SAVE** to save the reminder.

When you arrive at home, the 'Water the flowers' notification will appear.

## Creating reminders with Bixby Voice

Press and hold the Bixby key and say “Remind me to water the flowers when I get home”.

Bixby Voice will save what you said as a reminder.

## Checking reminder notifications

At the preset time or location, a notification pop-up window will appear. Tap **COMPLETE** or **SNOOZE**.

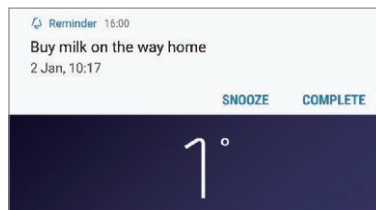

## Viewing the reminders list

Launch the **Reminder** app to view your reminders list. To view reminder details, select a reminder.

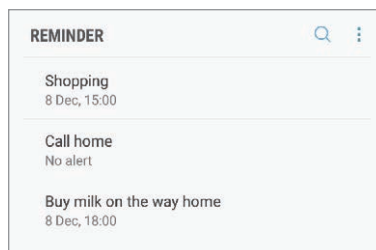

## Setting reminder details

Add or edit reminder details, such as frequency, date and time, or location.

- 1 Select a reminder to edit and tap **EDIT**. Alternatively, swipe right on a reminder and tap **Edit**.
- 2 Edit the conditions and tap **SAVE**.

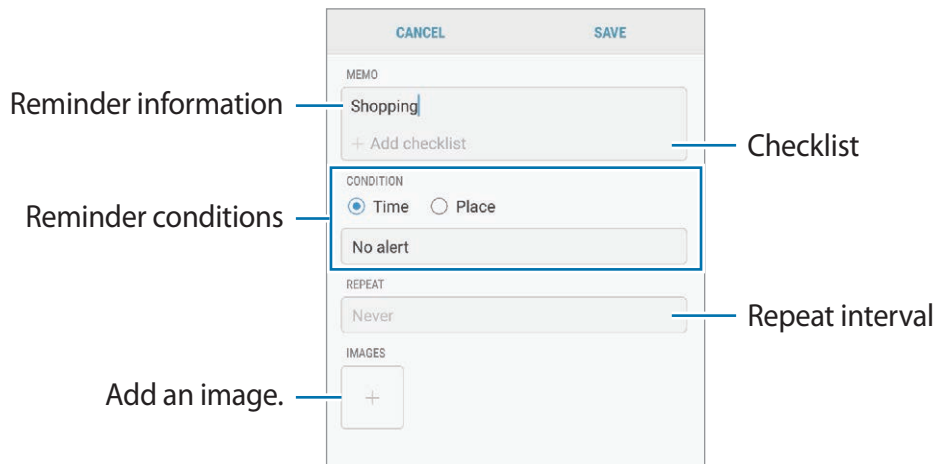

## Completing reminders

Mark reminders that you do not need to be reminded of as complete.

On the reminders list, select a reminder and tap **COMPLETE**. Alternatively, swipe to the left on a reminder.

## Restoring reminders

Restore reminders that have been completed.

- 1 On the reminders list, tap  → **Completed** → **EDIT**.
- 2 Tick items to restore and tap **RESTORE**.

Reminders will be added to the reminders list and you will be reminded at the preset times.

## Deleting reminders

To delete a reminder, swipe right on a reminder and tap **Delete**. To delete multiple reminders, tap and hold a reminder, tick reminders to delete, and then tap **DELETE**.

## Customizing Bixby settings

On the Bixby Home screen, tap  → **Settings**.

- **Samsung account:** View your Samsung account information.
- **HOME CARDS**
  - **Apps:** Select apps to show as cards on the Bixby Home screen.
  - **Show on Lock screen:** Select apps to show as cards when opening Bixby Home on the locked screen.
- **VOICE**
  - **Bixby Voice:** Activate or deactivate Bixby Voice. If you deactivate Bixby Voice, Bixby Voice will not launch when you press and hold the Bixby key or say the voice wake-up command.
  - **Background colour:** Change the background colour of the Bixby Voice full screen. As you earn more Bixby experience to level up, you can use more colours.
  - **Language and speaking style:** Set the language to communicate with Bixby Voice and set the style of voice feedback. The selected language is applied only when you talk with Bixby Voice.
  - **Voice feedback:** Activate or deactivate voice feedback from Bixby Voice.
  - **Feedback style:** Set Bixby Voice to respond in short statements or in a more conversational style.
  - **Voice wake-up:** Set Bixby Voice to wake up when it hears you say “Hi Bixby”. You can also change the settings for the voice wake-up feature.
  - **Unlock with voice password:** Set the device to unlock by saying your voice password to Bixby Voice.



- Your device can be unlocked by someone else who says the correct password.
- Voice password is less secure than Pattern, PIN, or Password.



- **Enhanced voice recognition:** Set Bixby Voice to improve voice recognition based on your pronunciation. Record your pronunciation to help Bixby Voice understand you better.



This feature may not be available depending on the language you set to communicate with Bixby Voice.

- **Dictation on keyboard:** Set Bixby Voice to start dictation mode when you press and hold the Bixby key while the Samsung keyboard is open.
  - **Read aloud in high quality:** Set Bixby Voice to read messages aloud in high quality audio.
  - **Bixby XP animation:** Set whether to show an animation when you earn Bixby XP.
  - **Ranking:** View your ranking among Bixby Voice users. Your ranking is based on how much Bixby experience you have earned in the last 30 days.
  - **Voice apps and services:** View Bixby Voice supported apps and each app's suggested commands.
  - **Bixby Labs:** View apps and voice commands that Bixby Voice is experimenting with at Bixby Labs. If you install the apps the Bixby Labs recommends, you can experience Bixby Voice in more apps.
  - **Auto-update 3rd party app plugin:** Set the device to automatically update plugins Bixby uses to control third party apps.
- **GENERAL**
    - **Bixby key:** Set whether to open Bixby Home when you press the Bixby key.
    - **Auto-update Bixby:** Set the device to update Bixby software automatically even when using your mobile network.



You can incur additional charges when using this feature.



- **Notifications:** Set to receive notifications about Bixby Home cards, marketing information, and more.
- **Privacy:** Set to use Bixby's interactive and customized services to enhance your experience. You can also delete Bixby interaction data.
- **About Bixby:** View the Bixby version and legal information.

# Phone

## Introduction

Make or answer voice and video calls.

## Making calls

- 1 Launch the **Phone** app and enter a phone number.  
If the keypad does not appear on the screen, tap  to open the keypad.
- 2 Tap  to make a voice call.

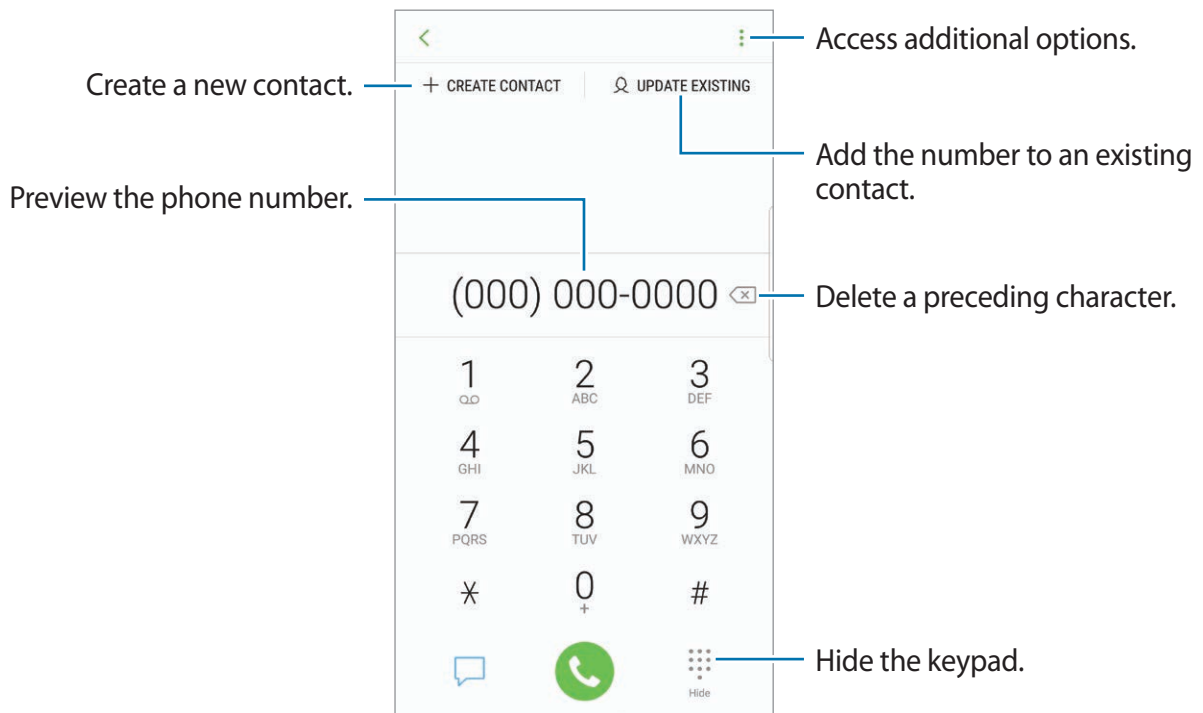

## Making calls from call logs or contacts list

Tap **RECENTS** or **CONTACTS**, and then swipe to the right on a contact or a phone number to make a call.

If this feature is deactivated, launch the **Settings** app, tap **Advanced features**, and then tap the **Swipe to call or send messages** switch to activate it.

## Using speed dial

Set speed dial numbers to quickly make calls.

To set a number to speed dial, tap **CONTACTS** →  → **Speed dial**, select a speed dial number, and then add a phone number.



To make a call, tap and hold a speed dial number on the keypad. For speed dial numbers 10 and up, tap the first digit(s) of the number, and then tap and hold the last digit.

For example, if you set the number **123** as a speed dial number, tap **1**, tap **2**, and then tap and hold **3**.

## Making calls from the locked screen

On the locked screen, drag  outside the circle.

## Making an international call

- 1 Tap  to open the keypad if the keypad does not appear on the screen.
- 2 Tap and hold **0** until the + sign appears.
- 3 Enter the country code, area code, and phone number, and then tap .

## Receiving calls



### Answering a call

When a call comes in, drag  outside the large circle.

### Rejecting a call

When a call comes in, drag  outside the large circle.

To send a message when rejecting an incoming call, drag the **SEND MESSAGE** bar upwards. You can send a text message or a sticker to reject a call. If **Add reminder** is selected, a reminder will be saved to alert you of the rejected call one hour later.

To create various rejection messages, launch the **Phone** app, tap  → **Settings** → **Quick decline messages**, enter a message, and then tap .

### Missed calls

If a call is missed, the  icon appears on the status bar. Open the notification panel to view the list of missed calls. Alternatively, launch the **Phone** app and tap **RECENTS** to view missed calls.

## Blocking phone numbers

Block calls from specific numbers added to your block list.

1 Launch the **Phone** app and tap  → **Settings** → **Block numbers**.

2 Tap , select contacts, and then tap **DONE**.

To manually enter a number, tap **Enter phone number**, enter a phone number, and then tap .

When blocked numbers try to contact you, you will not receive notifications. The calls will be logged in the call log.



You can also block incoming calls from people that do not show their caller ID. Tap the **Block unknown callers** switch to activate the feature.



## Options during calls



If the area around the rear camera and the fingerprint recognition sensor is covered, unwanted noises may incur during a call. Remove accessories, such as a screen protector or stickers, around the rear camera area.

### During a voice call

The following actions are available:

- : Access additional options.
- **Add call:** Dial a second call. The first call will be put on hold. When you end the second call, the first call will be resumed.
- **Extra volume:** Increase the volume.
- **Bluetooth:** Switch to a Bluetooth headset if it is connected to the device.
- **Speaker:** Activate or deactivate the speakerphone. When using the speakerphone, keep the device away from your ears.
- **Mute:** Turn off the microphone so that the other party cannot hear you.
- **Keypad / Hide:** Open or close the keypad.
- : End the current call.

## Adding a phone number to Contact

### Adding a phone number to Contacts from the keypad

- 1 Launch the **Phone** app.
- 2 Enter the number.  
If the keypad does not appear on the screen, tap  to open the keypad.
- 3 Tap **CREATE CONTACT** to create a new contact, or tap **UPDATE EXISTING** to add the number to an existing contact.

### Adding a phone number to Contacts from the calls list

- 1 Launch the **Phone** app and tap **RECENTS**.
- 2 Tap a caller's image, or tap a phone number → **Details**.
- 3 Tap **Create contact** to create a new contact, or tap **Update existing** to add the number to an existing contact.

## Adding a tag to a phone number

You can add tags to numbers without saving them to Contact. This allows you to view the caller's information when they call without having them listed in Contact.

- 1 Launch the **Phone** app and tap **RECENTS**.
- 2 Tap a phone number → **Details**.
- 3 Tap **Add tag**, enter a tag, and then tap **DONE**.  
When a call comes from that number, the tag will show under the number.

# Contacts

## Introduction

Create new contacts or manage contacts on the device.

## Adding contacts

### Creating a new contact

- 1 Launch the **Contacts** app, tap , and then select a storage location.
- 2 Enter contact information.

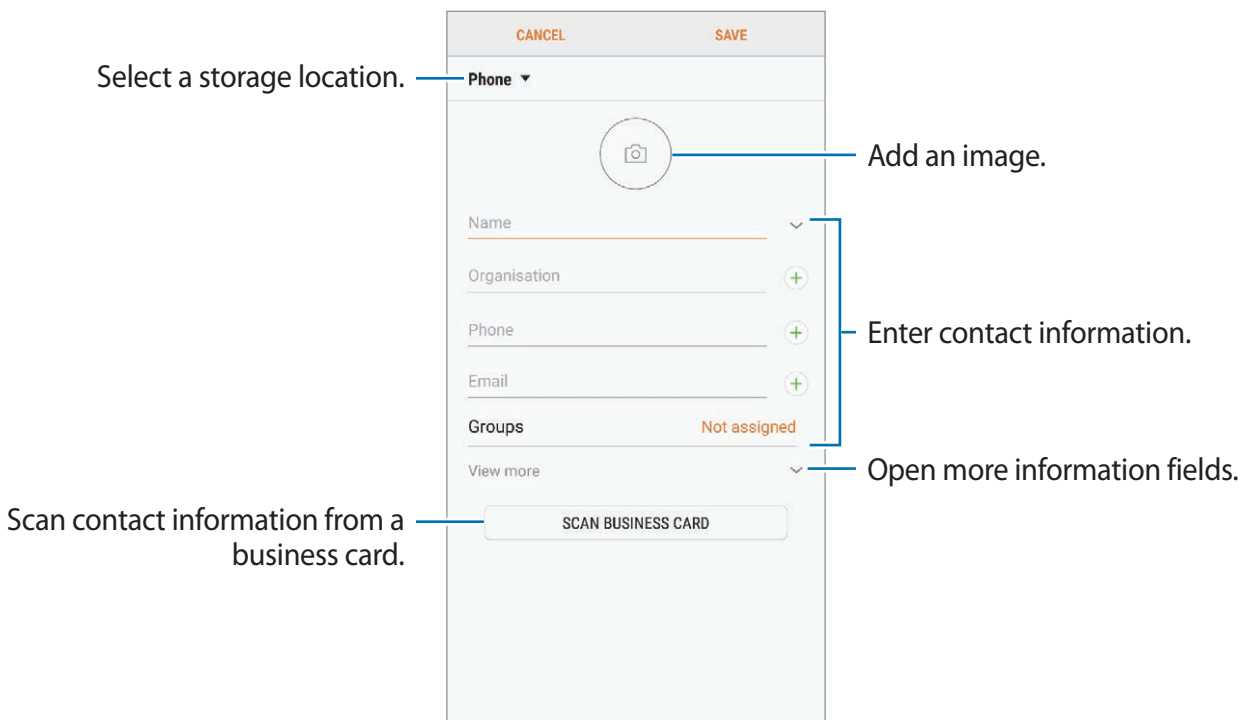

 Depending on the selected storage location, the types of information you can save may vary.

- 3 Tap **SAVE**.

## Importing contacts

Add contacts by importing them from other storages to your device.

- 1 Launch the **Contacts** app and tap  → **Manage contacts** → **Import/Export contacts** → **IMPORT**.
- 2 Select a storage location to import contacts from.
- 3 Tick VCF files or contacts to import and tap **DONE**.
- 4 Select a storage location to save contacts to and tap **IMPORT**.

## Syncing contacts with your web accounts

Sync your device contacts with online contacts saved in your web accounts, such as your Samsung account.

- 1 Launch the **Settings** app, tap **Cloud and accounts** → **Accounts** and select the account to sync with.
- 2 Tap **Sync account** and tap the **Sync Contacts** switch to activate it.  
For the Samsung account, tap  → **Sync settings** and tap the **Contacts** switch to activate it.

## Searching for contacts





Launch the **Contacts** app.

Use one of the following search methods:

- Scroll up or down the contacts list.
- Drag a finger along the index at the right side of the contacts list to scroll through it quickly.
- Tap the search field at the top of the contacts list and enter search criteria.



Tap the contact's image, or tap the contact's name → **Details**. Then take one of the following actions:

- : Add to favourite contacts.
- : Make a voice call.
- : Compose a message.
- : Compose an email.

## Sharing contacts

You can share contacts with others by using various sharing options.

- 1 Launch the **Contacts** app and tap  → **Share**.
- 2 Select contacts and tap **SHARE**.
- 3 Select a sharing method.

## Saving and sharing profile

Save and share your profile information, such as your photo and status message, with others using the profile sharing feature.



- The profile sharing feature may not be available depending on the region or service provider.
- The profile sharing feature is only available for contacts who have activated the profile sharing feature on their device.

- 1 Launch the **Contacts** app and select your profile.
- 2 Tap **EDIT**, edit your profile, and tap **SAVE**.
- 3 Tap  → **Profile sharing**, and then tap the switch to activate it.

To use the profile sharing feature, your phone number must be verified. You can view your contacts' updated profile information in **Contacts**.

To change the scope of contacts to share your profile with, tap **Share with**, select an item to share, and then select an option.

## Creating groups

You can add groups, such as family or friends, and manage contacts by group.

- 1 Launch the **Contacts** app and tap **Groups** → **CREATE**.
- 2 Enter a group name.  
To set a group ringtone, tap **Group ringtone** and select a ringtone.
- 3 Tap **Add member**, select contacts to add to the group, and then tap **DONE**.
- 4 Tap **SAVE**.

## Sending a group message

You can send a group message to a group's members at the same time.

Launch the **Contacts** app, tap **Groups**, select a group, and then tap  → **Send message**.

## Merging duplicate contacts

When you import contacts from other storages, or sync contacts with other accounts, your contacts list may include duplicate contacts. Merge duplicate contacts into one to streamline your contacts list.

- 1 Launch the **Contacts** app and tap  → **Manage contacts** → **Merge contacts**.
- 2 Tick contacts and tap **MERGE**.

## Deleting contacts

- 1 Launch the **Contacts** app and tap  → **Delete**.
- 2 Select contacts and tap **DELETE**.

To delete contacts one by one, open the contacts list and tap a contact's image or tap a contact's name → **Details**. Then tap  → **Delete**.

# Messages

## Introduction

Send and view messages by conversation.

## Sending messages



You may incur additional charges for sending messages when you are roaming.

- 1 Launch the **Messages** app and tap .
- 2 Add recipients and tap **START**.
- 3 Enter a message.

To record and send a voice message, tap and hold , say your message, and then release your finger. The recording icon appears only while the keyboard is hidden.

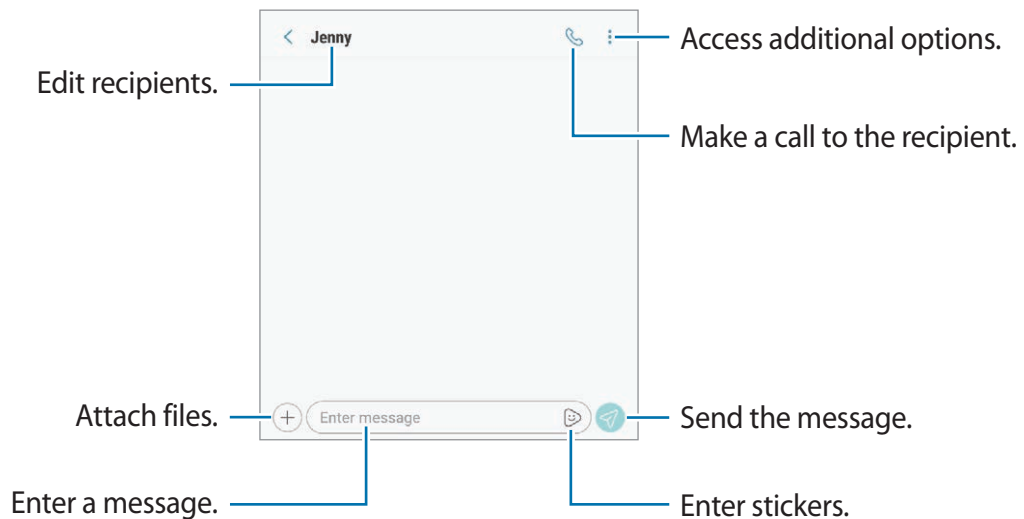

- 4 Tap  to send the message.

## Sending My Emoji stickers

You can send My Emoji stickers that look like you via messages.

While composing a message, tap  on the Samsung keyboard and tap the My Emoji icon. My Emoji stickers will appear. Select the sticker that you want to share.



My Emoji stickers will appear after you create My Emoji in the **Camera** app. Refer to [My Emoji](#) for more information.

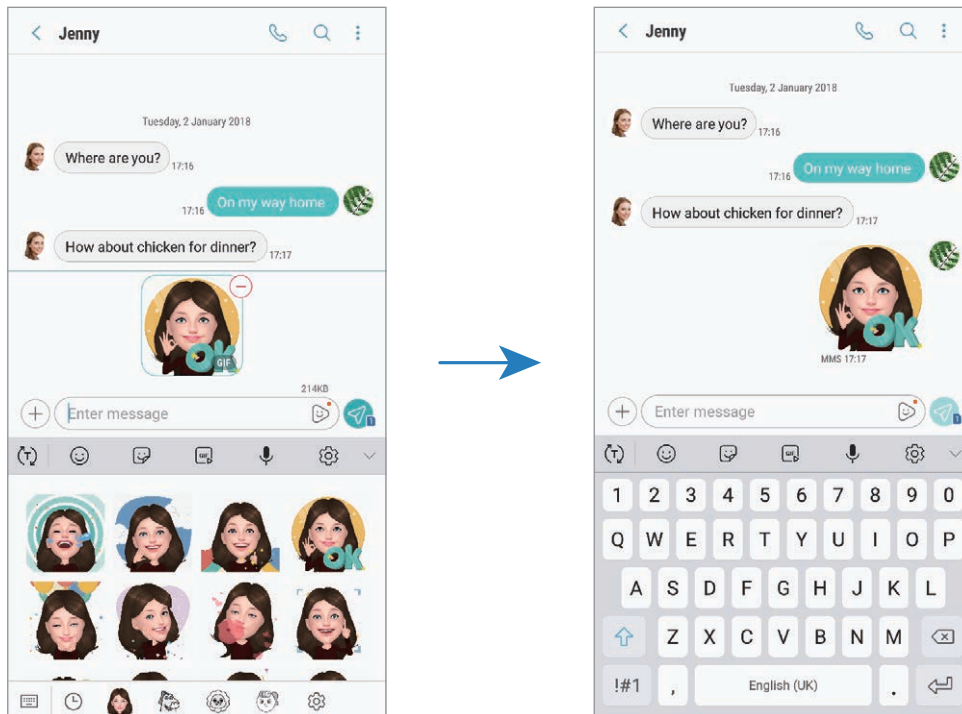

## Viewing messages

Messages are grouped into message threads by contact.



You may incur additional charges for receiving messages when you are roaming.



- 1 Launch the **Messages** app and tap **CONVERSATIONS**.
- 2 On the messages list, select a contact.

### 3 View your conversation.

To reply to the message, tap **Enter message**, enter a message, and then tap .

## Blocking unwanted messages

Block messages from specific numbers added to your block list.

- 1 Launch the **Messages** app and tap  → **Settings** → **Block numbers and messages** → **Block numbers**.
- 2 Tap **INBOX** and select a contact. Or, Tap **CONTACTS**, select contacts, and then tap **DONE**.  
To manually enter a number, tap **Enter number**, enter a phone number, and then tap .

## Setting the message notification

You can change notification sound, display options, and more.

- 1 Launch the **Messages** app, tap  → **Settings** → **Notifications**, and then tap the switch to activate it.
- 2 Change the notification settings.

## Setting a message reminder

You can set an alert at an interval to let you know that you have unchecked notifications. If this feature is not activated, launch the **Settings** app, tap **Accessibility** → **Notification reminder**, and then tap the switch to activate it. Then, tap the **Messages** switch to activate it.

# Internet

## Introduction

Browse the Internet to search for information and bookmark your favourite webpages to access them conveniently.

## Browsing webpages

- 1 Open the **Samsung** folder and launch the **Internet** app.
- 2 Tap the address field.
- 3 Enter the web address or a keyword, and then tap **Go**.

To view the toolbars, drag your finger downwards slightly on the screen.

To switch between tabs quickly, swipe to the left or right on the address field.

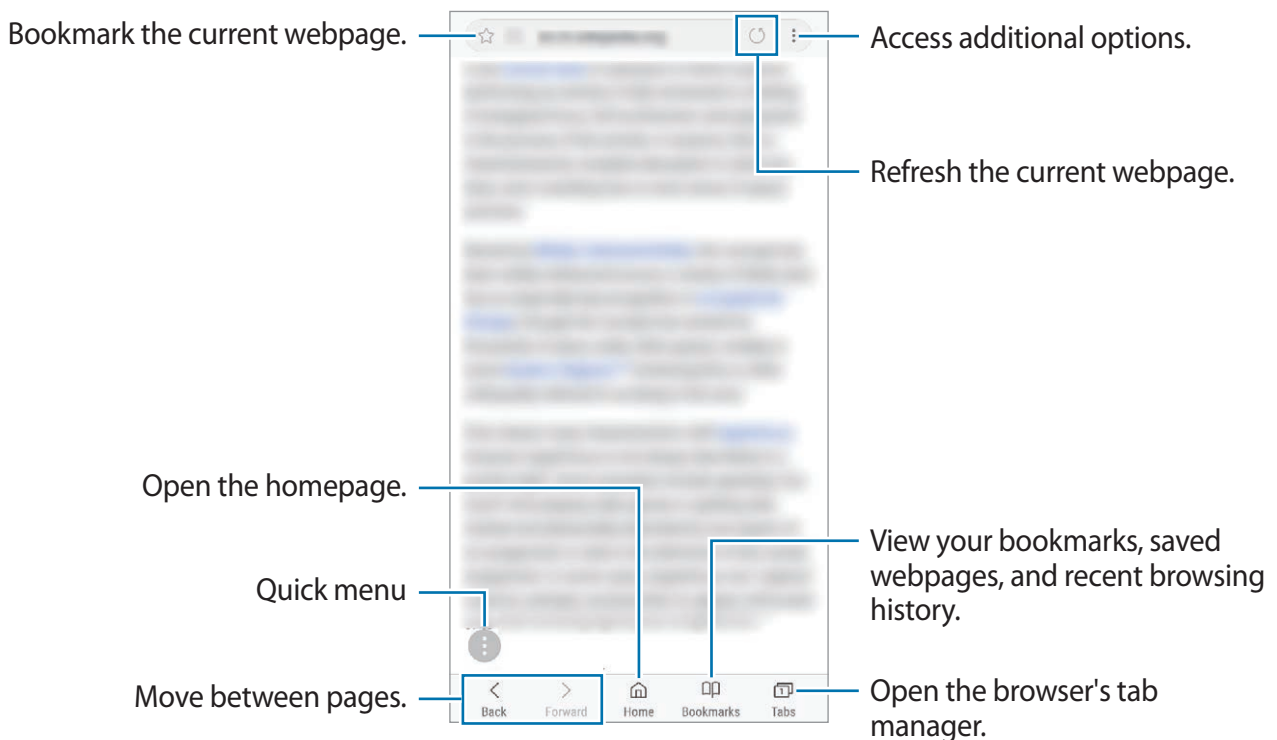

## Using secret mode

In secret mode, you can separately manage open tabs, bookmarks, and saved pages. You can lock secret mode using a password and your fingerprint or irises.

### Activating secret mode

In the toolbar at the bottom of the screen, tap **Tabs** → **TURN ON SECRET MODE**. If you are using this feature for the first time, set whether to use a password or your biometric data for secret mode.



In secret mode, you cannot use some features, such as screen capture.

In secret mode, the device will change the colour of the toolbars.

### Changing security settings

You can change your password or the lock method.

Tap  → **Settings** → **Privacy** → **Secret mode security** → **Change password**. To set your registered fingerprint or irises as the lock method along with the password, tap the **Fingerprints** or **Irises** switch to activate it. Refer to [Fingerprint recognition](#) or [Iris recognition](#) for more information about using your fingerprints or irises.

### Deactivating secret mode



In the toolbar at the bottom of the screen, tap **Tabs** → **TURN OFF SECRET MODE**.



# Email

## Setting up email accounts

Set up an email account when opening **Email** for the first time.

- 1 Open the **Samsung** folder and launch the **Email** app.
- 2 Enter the email address and password, and then tap **SIGN IN**.  
To manually register an email account, tap **MANUAL SETUP**.
- 3 Follow the on-screen instructions to complete the setup.

To set up another email account, tap  →  → **Add account**.

If you have more than one email account, you can set one as the default account. Tap  →  →  → **Set default account**.

## Sending emails



- 1 Tap  to compose an email.
- 2 Add recipients and enter an email text.
- 3 Tap **SEND** to send the mail.

## Reading emails

When **Email** is open, the device will automatically retrieve new emails. To manually retrieve emails, swipe downwards on the screen.

Tap an email on the screen to read it.



If email syncing is disabled, new emails cannot be retrieved. To enable email syncing, tap  →  → your account name, and then tap the **Sync account** switch to activate it.



# Camera

## Introduction

Take photos and record videos using various modes and settings.

### Camera etiquette

- Do not take photos or record videos of other people without their permission.
- Do not take photos or record videos where legally prohibited.
- Do not take photos or record videos in places where you may violate other people's privacy.

## Launching Camera

Use the following methods to launch Camera:



- Launch the **Camera** app.
- Press the Power key twice quickly.
- On the locked screen, drag  outside the circle.







- Some methods may not be available depending on the region or service provider.
- Some camera features are not available when you launch the **Camera** app from the locked screen or when the screen is turned off while the screen lock method is set.
- If photos you take appear blurry, clean the camera lens and try again.

## Basic shooting

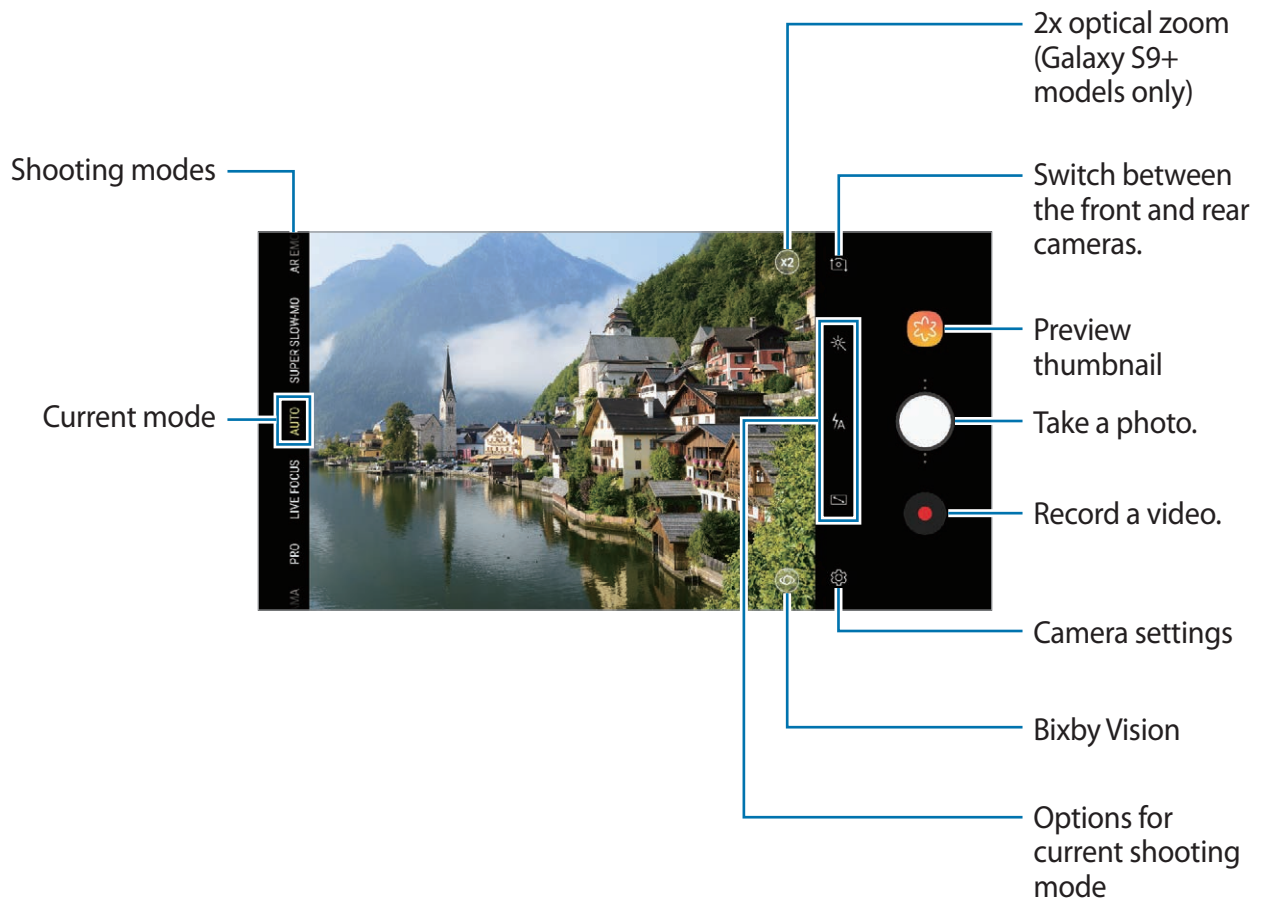
### Taking photos or recording videos

- 1 Tap the image on the preview screen where the camera should focus.
- 2 Tap  to take a photo or tap  to record a video.



- To adjust the brightness of photos or videos, tap the screen. When the adjustment bar appears, drag  on the adjustment bar towards **+** or **-**.
- To capture an image from the video while recording, tap .
- To change the focus while recording a video, tap where you want to focus. To use auto focus mode, tap .





- The preview screen may vary depending on the shooting mode and which camera is being used.
- The camera automatically shuts off when unused.
- Make sure that the lens is not damaged or contaminated. Otherwise, the device may not work properly in some modes that require high resolution.
- Your device's camera features a wide-angle lens. Minor distortion may occur in wide-angle photos or videos and does not indicate device performance problems.
- The maximum recording time may reduce when you record video at high resolution.

## Adding another camera button

Add another camera button to the location you want on the screen to capture photos more conveniently.

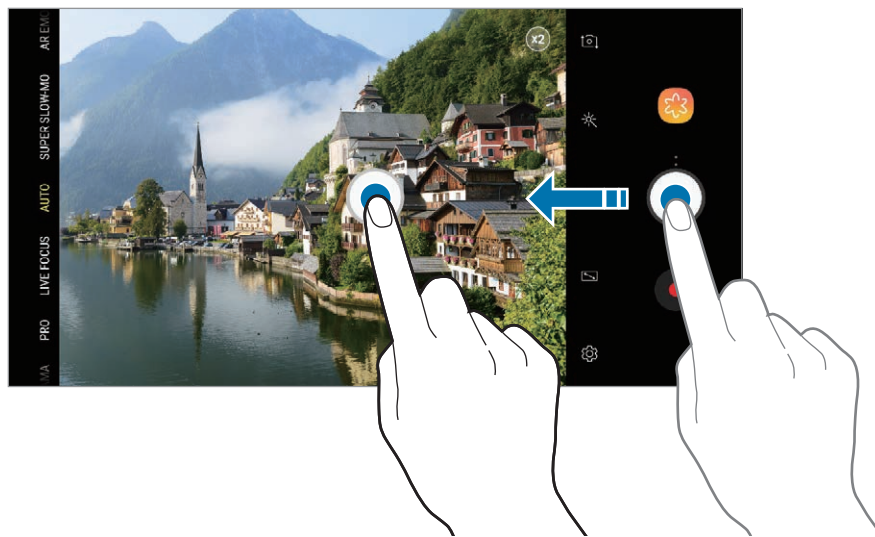
Drag  to the preview screen.



If another camera button is not added, tap  on the preview screen and tap the **Floating Camera button** switch to activate it.

## Setting the camera button action

You can take a series of photos or create an animated GIF by tapping and holding the camera button.

On the preview screen, tap  → **Hold Camera button to** and select an action you want to use.



- **Take burst shot:** Take a series of photos.
- **Create GIF:** Create an animated GIF with sequential photos you taken.



This feature is available only in some shooting modes.

## Zooming in and out

Use various methods to zoom in or out.

- Spread two fingers apart on the screen to zoom in, and pinch to zoom out.
- Control the zoom with one finger. Drag  on the zoom bar towards **+** or **—**.
- Use the 2x optical zoom to get clear photos even when you zoom in on a far-away subject. On the preview screen, tap . (Galaxy S9+ models only)



- Zooming features are available only when using the rear camera.
- If you use the video zoom feature for a long time while recording a video, the video quality may diminish to prevent your device from overheating. (Galaxy S9+ models only)
- The 2x optical zoom may not work in low-light environments. (Galaxy S9+ models only)

## Using the focus and exposure features

### Locking the focus (AF) and exposure (AE)

You can lock the focus or exposure on a selected area to prevent the camera from automatically adjusting based on changes to the subjects or light sources.

Tap and hold the area to focus. The AF/AE frame will appear on the area and the focus and exposure setting will be locked. The setting remains locked even after you take a photo.



This feature is available only in **AUTO** and **PRO** modes.

### Separating the focus area and the exposure area

You can separate the focus area and the exposure area.

Tap and hold the preview screen. The AF/AE frame will appear on the screen. Drag the frame to the area where you want to separate the focus area and the exposure area.



This feature is available only in **PRO** mode.

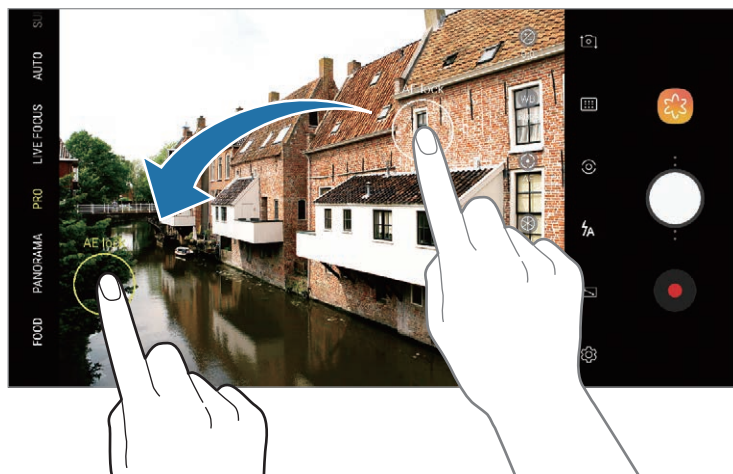

## SUPER SLOW-MO

You can capture all of the moments that you do not want to miss at ultra high speed and play them back in slow motion. The super slow motion feature will let you record special occasions and fast-moving scenes and enjoy them in a fun, new way. When you play the video, the segments recorded in super slow motion will play in slow motion.

- **Multi-take:** Record a video and capture multiple moments in super slow motion.
- **Single-take:** Record a short video by capturing a single moment in super slow motion.

### Recording in multi-take

While recording a video, all of the moments that the subject is moving will be captured in super slow motion.

- 1 On the shooting modes list, tap **SUPER SLOW-MO**.
- 2 Make sure that the mode is set to **Auto**.

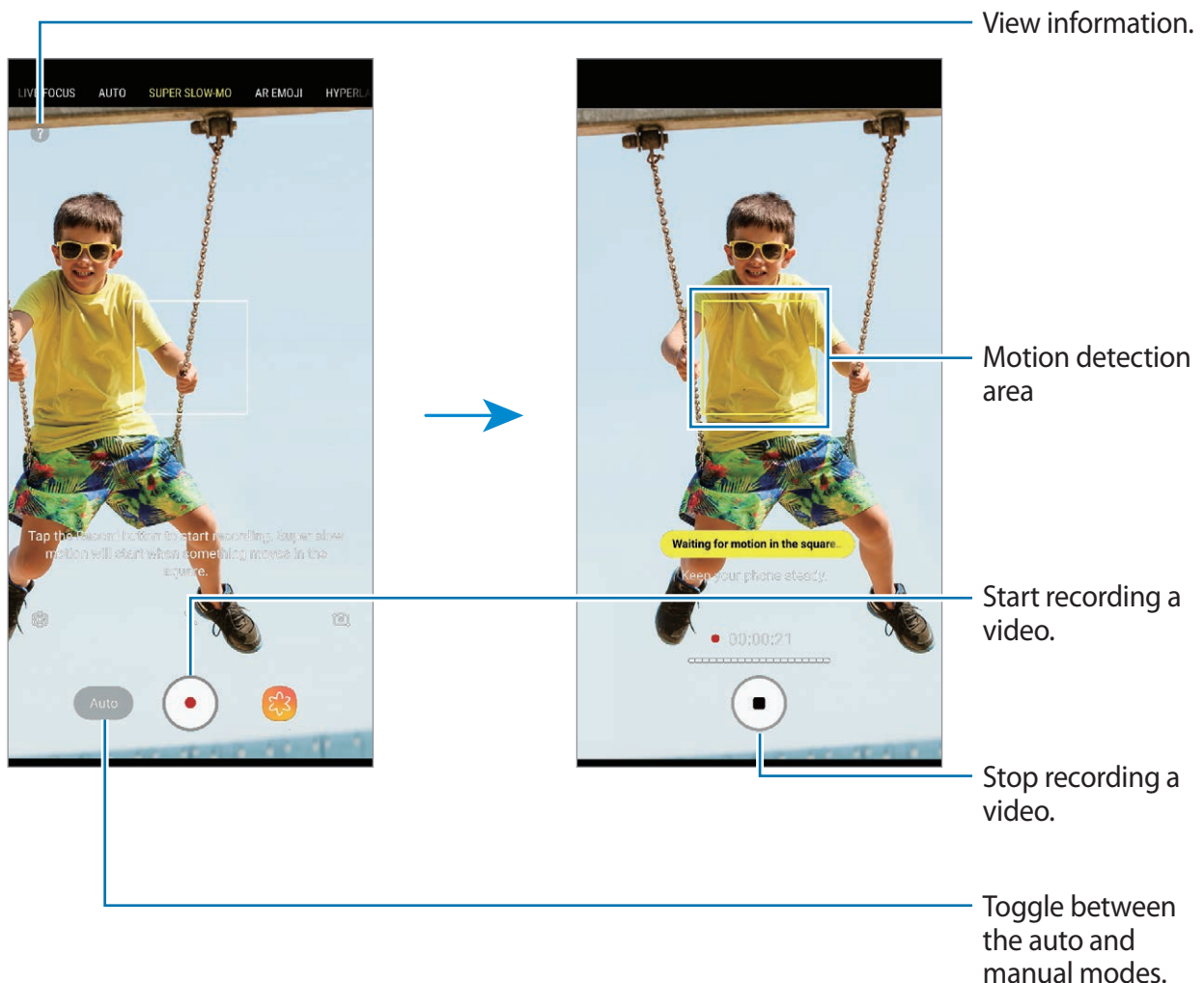

- 3 Tap  to start recording a video.

When motion is detected in the motion detection area, the device will capture the moment in super slow motion. You can see how many times you have used super slow motion by the number of white dots that appear above the  icon. You can use super slow motion up to 20 times in a single video.

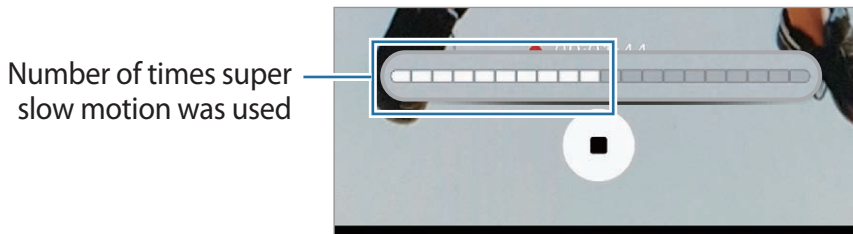



-  If the device shakes, motion may be detected and an unwanted moment may be recorded in super slow motion.

- 4 Tap  to stop recording the video.

## Recording in single-take

Record a short video by capturing a single moment that the subject is moving.

- 1 On the shooting modes list, tap **SUPER SLOW-MO**.
- 2 On the preview screen, tap  → **Super slow-mo** → **Single-take** and double-tap the Back button.
- 3 Make sure the mode is set to **Auto**.
- 4 Tap .

When motion is detected in the motion detection area, the device will capture the moment in super slow motion and save it as a short video.

-  If the device shakes, motion may be detected and an unwanted moment may be recorded in super slow motion.

## Changing the motion detection area

To move the motion detection area, tap and hold the area inside the frame and drag it to a new location. To adjust the area size, tap and hold a corner of the frame and drag it.

## Recording in manual mode

You can also choose to record in super slow motion by manually tapping a button.

On the super slow motion preview screen, tap **Auto** to switch to **Manual** mode.

At the moment you want to use super slow motion, tap .

## Playing super slow motion videos



Select a super slow motion video and tap .

Random background music will automatically accompany the video during playback.

## Editing super slow motion videos

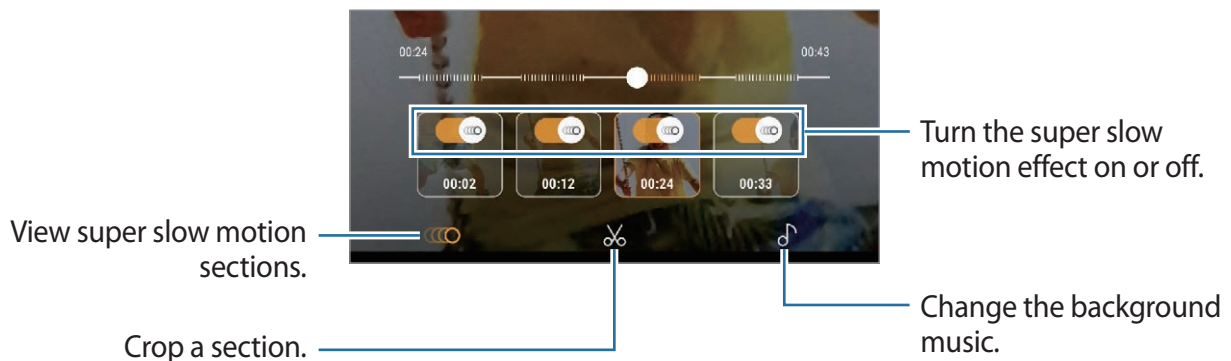
On the playback screen, you can edit the video and save it as a different file or share it.



-  : Select and view a super slow motion section of the video. If you want to turn off the super slow motion effect, tap .



- ✂: Crop out a desired section. Drag the start bracket and the end bracket to the desired points to select the section to keep.

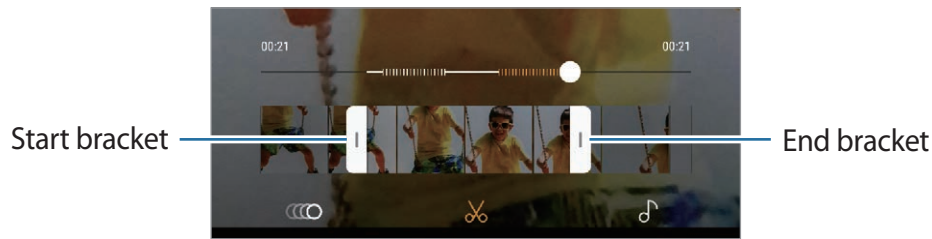

- 🎵: Change the background music.

## Sharing your video as an animated GIF

- 1 Select a super slow motion video and drag upwards on the video preview screen. Short clips with different effects will appear.
- 2 Select a clip you want.
- 3 Tap **SHARE**.  
The clip will be saved as an animated GIF.
- 4 Select a sharing method.



- When saving as an animated GIF, the video quality may be degraded as the file capacity is reduced.
- Some social network services and messenger apps may not support the GIF sharing feature.
- This feature is only available for unedited original videos recorded in super slow motion.

## LIVE FOCUS (Galaxy S9+ models only)

The Live focus feature allows the camera to capture the subject and the background separately so that you can get an out-of-focus photo with the focus on the subject. Moreover, the Dual capture feature allows you to take a close-up photo zoomed in on the subject and a wide angle photo with a broader background, all in one shot.

### Taking portraits that stand out using the Live focus feature

Adjust the background blur level on the preview screen and take a photo that highlights the subject.



- Use this feature in a place that has sufficient light.
- The background blur may not be applied properly in the following conditions:
  - The device or the subject is moving.
  - The subject is thin or transparent.
  - The subject has a similar colour or pattern to the background.
  - The subject or background is plain.

- 1 On the shooting modes list, tap **LIVE FOCUS**.
- 2 Drag the background blur adjustment bar to the left or right to adjust the blur level.

3 Tap  to take a photo.

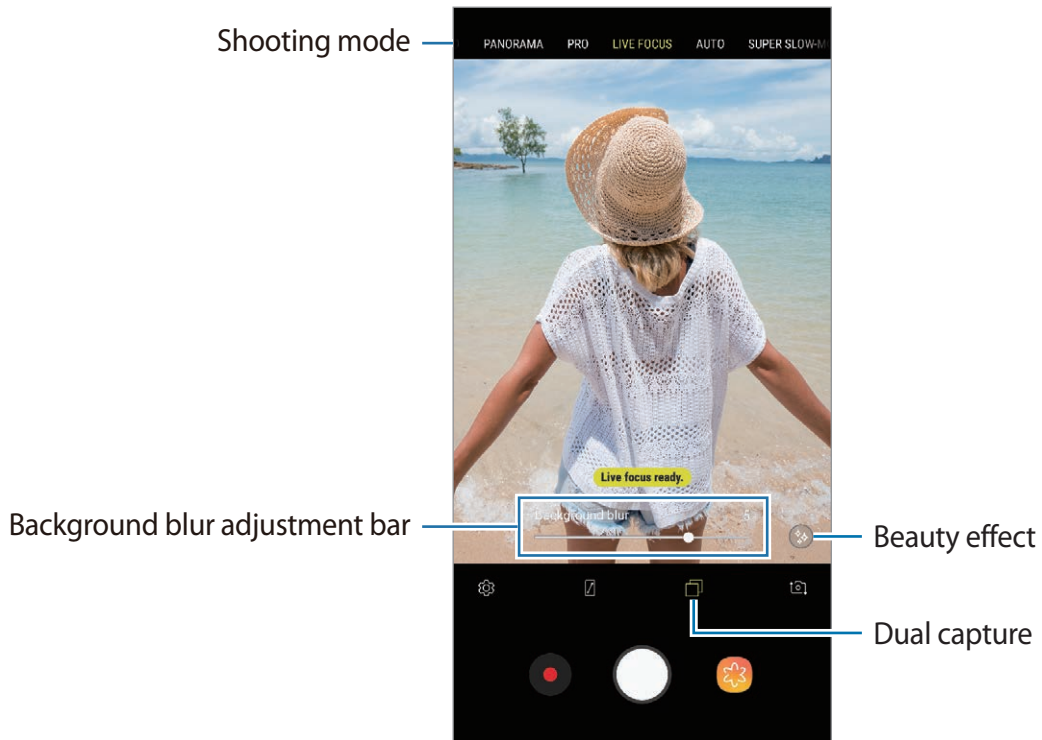

## Editing the background of the Live Focus photos

You can also edit the background blur level of a photo taken with the Live focus feature. When the background lighting appears in blurred points, you can change the shape of the background blur. Select a shape, such as a heart, star, or flower, to decorate the photo and make it look different.

### Adjusting the background blur level



### Changing the shape of the background blur

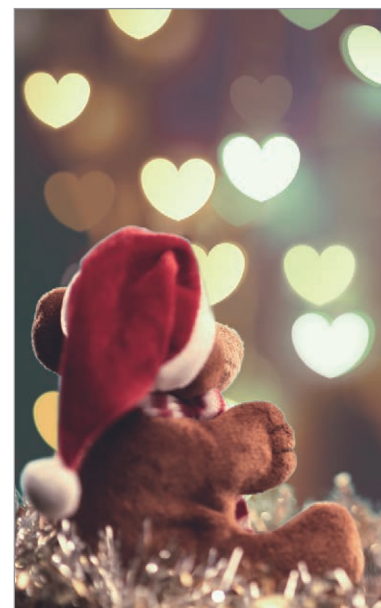

- 1 Select a photo taken with the Live focus feature and tap **ADJUST BACKGROUND BLUR**.
- 2 To adjust the background blur level, drag the background blur adjustment bar to the left or right.

To change the background blur shape, drag the effect list to the left or right and select an effect you want. The effect list will appear only when the photo has blur shape in the background.



Adjust the background blur level.

Change the background blur shape.

- 3 Tap ✓ to save the photo.

## Taking the hidden background with the Dual capture feature

With one shot, you can capture both a close-up photo and a wide angle photo with a broader background. You can view the background scenery which was hidden on the preview screen.

On the shooting modes list, tap **LIVE FOCUS**. Make sure the Dual capture feature is activated (📷), and then take a photo. Select the photo and view the close-up and wide angle photos.



A close-up photo



A wide angle photo

## AR EMOJI

### My Emoji

You can express yourself in fun and creative ways with a My Emoji that looks just like you. You can capture photos and videos with My Emoji or share stickers of My Emoji with others.

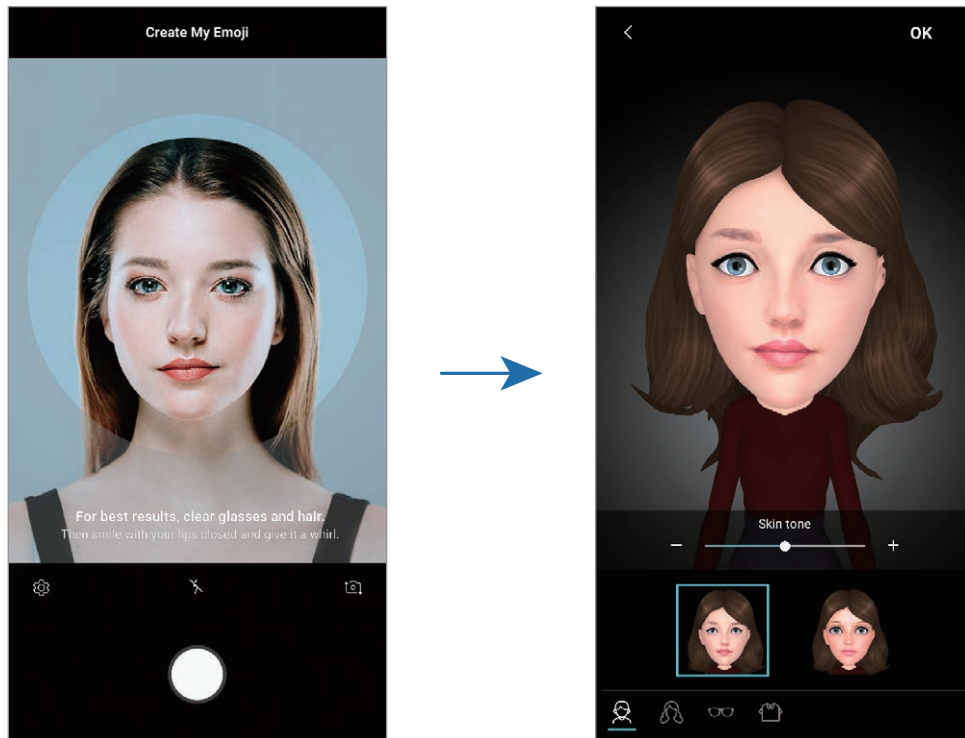



### Creating My Emoji

- 1 On the shooting modes list, tap **AR EMOJI**.
- 2 Tap **Create My Emoji**.
- 3 Align your face on the screen and tap  to take a photo.
- 4 Select My Emoji's gender and tap **NEXT**.
- 5 Decorate My Emoji and tap **OK**.

## Capturing photos and videos with My Emoji

You can capture photos and videos with My Emoji that mimics your expressions.

- 1 On the shooting modes list, tap **AR EMOJI**.
- 2 Tap  and select a My Emoji.
- 3 Tap  to take a photo or tap  to record a video.

## Deleting My Emoji

Tap and hold the My Emoji that you want to delete and tap .

## Using My Emoji stickers

You can use My Emoji stickers during a conversation via messages or on a social network.

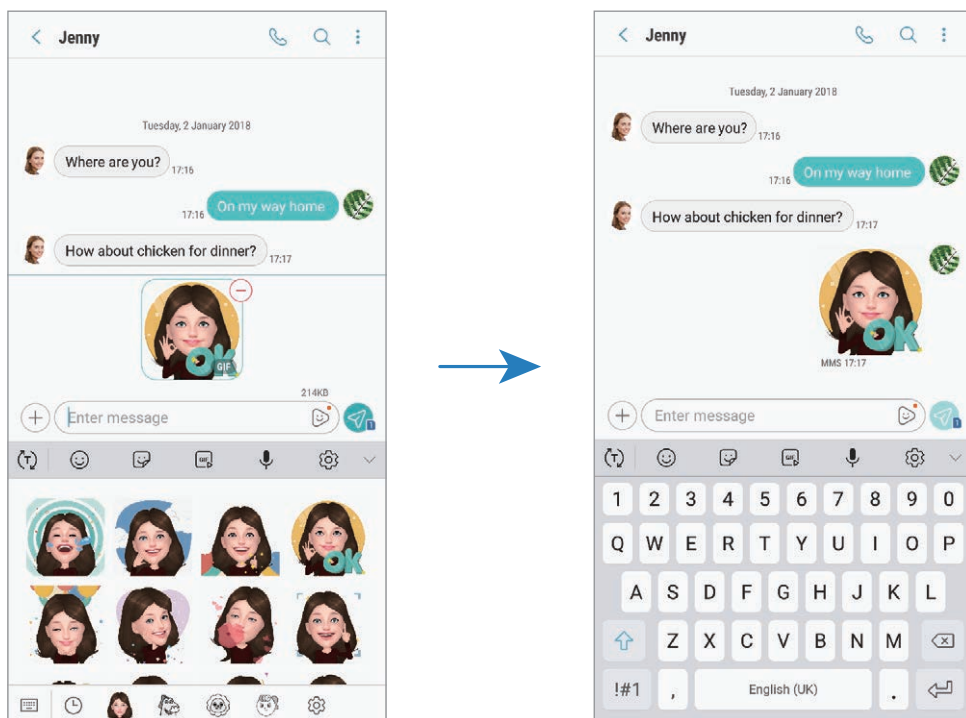

On the Samsung keyboard, tap  and tap the My Emoji icon. My Emoji stickers with various expressions will appear. Select one of the My Emoji stickers.

The My Emoji sticker will be inserted.







## Deleting My Emoji stickers



- 1 On the Samsung keyboard, tap  → .
- 2 Select the My Emoji stickers you want to delete and tap **DELETE**.

## Live stickers

Capture photos and videos with various live stickers. As you move your face, stickers will track with your movements. You can also record a lovely and funny sticker that keeps moving in a video.

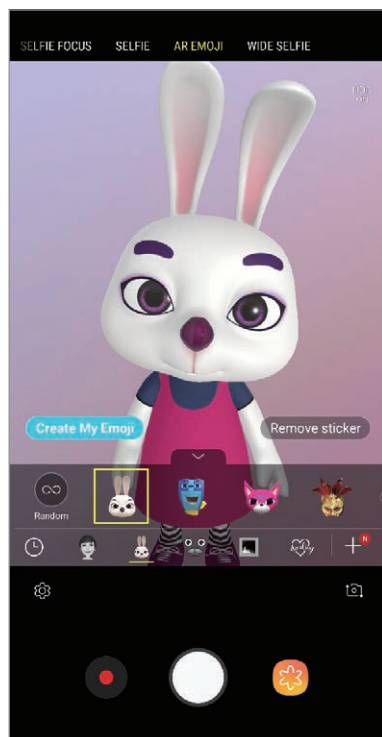
- 1 On the shooting modes list, tap **AR EMOJI**.
- 2 Tap  or  and select a sticker you want.



- 3 Tap  to take a photo or tap  to record a video.

## Applying stickers randomly

You can apply stickers randomly, instead of selecting one from the stickers list. Tap **Random** repeatedly until the sticker you want appears.

## Using shooting modes

To change the shooting mode, drag the shooting modes list to the left or right, or swipe to the left or right on the preview screen.

Select a shooting mode you want.



You can edit the shooting modes list. On the preview screen, tap  → **Edit camera modes**. Alternatively, tap and hold the shooting modes list on the preview screen.



### Auto mode

Auto mode allows the camera to evaluate the surroundings and determine the ideal mode for the photo.

On the shooting modes list, tap **AUTO**.

### Pro mode

Capture photos and videos while manually adjusting various shooting options, such as exposure value and ISO value.



On the shooting modes list, tap **PRO**. Select options and customize the settings, and then tap  to take a photo or tap  to record a video.







### Available options

-  : Select an ISO value. This controls camera light sensitivity. Low values are for stationary or brightly lit objects. Higher values are for fast-moving or poorly lit objects. However, higher ISO settings can result in noise in photos.



If the shutter speed is set manually, you cannot set the ISO setting to **AUTO**.

-  : Adjust the shutter speed. A slow shutter speed allows more light in, so the photo becomes brighter. This is ideal for photos of scenery or photos taken at night. A fast shutter speed allows less light in. This is ideal for taking photos of fast-moving subjects. You can select an aperture value that will determine the brightness and depth of field. Tap **F1.5** or **F2.4**.
-  : Select a colour tone. To create your own colour tone, tap **Tone 1** or **Tone 2**.

- : Change the focus mode. Drag the adjustment bar towards  or  to manually adjust the focus. To switch to auto focus mode, tap **MANUAL**.
- : Select an appropriate white balance, so images have a true-to-life colour range. You can set the colour temperature. Tap  and drag your finger on the colour temperature bar.
- : Change the exposure value. This determines how much light the camera's sensor receives. If the image is too dark, increase the exposure. If the image is too light, decrease the exposure.



If the shutter speed is set manually, you cannot change the exposure value. The exposure value will change and be displayed based on the shutter speed setting.



## Panorama mode

Using panorama mode, take a series of photos and then stitch them together to create a wide scene.



To get the best shots using panorama mode, follow these tips:

- Move the camera slowly in one direction.
- Keep the image within the frame on the camera's viewfinder. If the preview image is out of the guide frame or you do not move the device, the device will automatically stop taking photos.
- Avoid taking photos of indistinct backgrounds, such as an empty sky or a plain wall.

- 1 On the shooting modes list, tap **PANORAMA**.
- 2 Tap  and move the device slowly in one direction.
- 3 Tap  to stop taking photos.

## Taking a motion panorama

You can take and view a panorama with motion.







When taking motion panoramas, sound will not be recorded.

- 1 On the panorama preview screen, make sure the motion feature is activated () and take a motion panorama.
- 2 On the preview screen, tap the preview thumbnail.
- 3 Tap **VIEW AS MOTION PANORAMA**.  
The captured motion panorama will be played.
- 4 Tilt the device or swipe on the screen to rotate the captured motion panorama.  
To save the motion panorama as a video file, tap **SAVE VIDEO**.

## Hyperlapse mode

Record scenes, such as passing people or cars, and view them as fast-motion videos.



- 1 On the shooting modes list, tap **HYPERLAPSE**.
- 2 Tap  and select a frame rate option.  
If you set the frame rate to **Auto**, the device will automatically adjust the frame rate according to the changing rate of the scene.
- 3 Tap  to start recording.
- 4 Tap  to finish recording.
- 5 On the preview screen, tap the preview thumbnail and tap  to view the video.

## Food mode

Take photos of food with more vibrant colours and blurred edges.

- 1 On the shooting modes list, tap **FOOD**.
- 2 Tap the screen and drag the circular frame over the area to highlight.  
The area outside the circular frame will be blurred.  
To resize the circular frame, drag a corner of the frame.







- 3 Tap  and drag the adjustment bar to adjust the colour tone.
- 4 Tap  to take a photo.

## Slow motion mode

Record a video for viewing in slow motion. You can specify sections of your videos to be played in slow motion.



You must first add this mode to the shooting modes list before you can use it. On the preview screen, tap  → **Edit camera modes** → **Rear camera**, and then tick **Slow motion**.

- 1 On the shooting modes list, tap **SLOW MOTION**.
- 2 Tap  to start recording.
- 3 When you are finished recording, tap  to stop.
- 4 On the preview screen, tap the preview thumbnail.
- 5 Tap .

The fastest section of the video will be set as a slow motion section and the video will start playing. Up to two slow motion sections will be created based on the video.

To edit the slow motion section, drag  to the left or right.

## Sports mode

Take clearer photos of fast-moving subjects, such as a person running or a pet in motion.

On the shooting modes list, tap **SPORTS**.



You must first add this mode to the shooting modes list before you can use it. On the preview screen, tap  → **Edit camera modes** → **Rear camera**, and then tick **Sports**.

## Selective focus mode (Galaxy S9 models only)

Use the out-of-focus effect to make specific objects stand out in a photo.

- 1 On the shooting modes list, tap **SELECTIVE FOCUS**.
- 2 Tap the image on the preview screen where the camera should focus.
- 3 Tap  to take a photo.
- 4 Tap the preview thumbnail.
- 5 Tap **ADJUST BACKGROUND BLUR** and select one of the following:
  - **Near focus:** Make the subject stand out and blur the background around the subject.
  - **Far focus:** Blur the subject and make the background stand out around the subject.
  - **Pan focus:** Make the subject and its background stand out.

- 6 Tap **SAVE**.



- It is recommended that you position subjects within 50 cm of the device. Position the subject that you want to focus on close to the device.
- When taking photos, ensure there is sufficient distance between the subject and the background. The distance should be more than three times the distance between the device and the subject.
- Hold the device steady and remain still while taking a photo.
- The quality of photos taken by the device can be affected in the following conditions:
  - The device or the subject is moving.
  - There is strong background light, low levels of light, or you are taking photos indoors.
  - The subject has a similar colour or pattern to the background.

## Selfie mode

Take self-portraits with the front camera. You can preview various beauty effects on the screen.

1 On the preview screen, swipe upwards or downwards, or tap  to switch to the front camera for self-portraits.

2 On the shooting modes list, tap **SELFIE**.

3 Face the front camera lens.

4 Tap  to take a photo.

Alternatively, show your palm to the front camera. After recognizing your palm, a countdown timer will appear. When the time is up, the device will take a photo.



You can also take photos by tapping the heart rate sensor or the screen. To use various shooting options for the front camera, tap  → **Shooting methods**, and then tap the switches to activate them.

## Applying beauty effects

You can apply the spotlight effect or modify facial features, such as your skin tone or face shape, before taking self-portraits. You can also try various makeups on your face.



1 On the preview screen, tap .

2 Select the options to apply beauty effects to your face and take a photo of yourself.



## Selfie focus mode

Take selfies that focus on your face by blurring the background.

- 1 On the preview screen, swipe upwards or downwards, or tap  to switch to the front camera for self-portraits.
- 2 On the shooting modes list, tap **SELFIE FOCUS**.
- 3 Face the front camera lens.
- 4 Tap  to take a photo.

Alternatively, show your palm to the front camera. After recognizing your palm, a countdown timer will appear. When the time is up, the device will take a photo.



You can also take photos by tapping the heart rate sensor or the screen. To use various shooting options for the front camera, tap  → **Shooting methods**, and then tap the switches to activate them.

## Applying beauty effects

You can adjust the skin tone before taking self-portraits.

- 1 On the preview screen, tap .
- 2 Select the options to apply beauty effects to your face and take a photo of yourself.
  - **Colour:** Adjust the colour tone.
  - **Skin Tone:** Make your skin appear brighter and clearer.

## Wide selfie mode

Take a wide self-portrait and include as many people in the photo as possible to avoid leaving people out.

1 On the preview screen, swipe upwards or downwards, or tap  to switch to the front camera for self-portraits.

2 On the shooting modes list, tap **WIDE SELFIE**.

3 Face the front camera lens.

4 Tap  to take a photo.

Alternatively, show your palm to the front camera. After recognizing your palm, a countdown timer will appear. When the time is up, the device will take a photo.



You can also take photos by tapping the heart rate sensor or the screen. To use various shooting options for the front camera, tap  → **Shooting methods**, and then tap the switches to activate them.

5 Slowly swivel the device left and then right or vice versa to take a wide self-portrait.

The device will take additional photos when the white frame moves to each end of the viewfinder window.



- Make sure to keep the white frame inside the viewfinder window.
- The subjects should remain still while taking wide self-portraits.
- The top and bottom parts of the image displayed on the preview screen may be cut out of the photo depending on the shooting conditions.

## Taking a wide self-portrait with motion

You can take and view a wide self-portrait with motion.



- When taking a wide self-portrait with motion, sound will not be recorded.
- Depending on the shooting conditions, motion may not be saved.

- 1 On the wide selfie preview screen, make sure the motion feature is activated () and take a wide self-portrait with motion.
- 2 On the preview screen, tap the preview thumbnail.
- 3 Tap **MOTION WIDE-ANGLE SELFIE**.  
The captured wide self-portrait will be played.
- 4 Tilt the device or swipe on the screen to rotate the captured wide self-portrait.  
To save the wide self-portrait as a video file, tap **SAVE VIDEO**.

## Customizing camera settings

### Options for current shooting mode

On the preview screen, use the following options.



The available options may vary depending on the shooting mode and which camera is being used.

- : Turn on and off the full preview screen.
- : Select a frame rate.
- : Activate or deactivate the flash.
- : Select a filter effect to use when taking photos or recording videos.
- : Select a metering method. This determines how light values are calculated. **Centre-weighted** uses the light in the centre portion of the shot to calculate the exposure of the shot. **Spot** uses the light in a concentrated centre area of the shot to calculate the exposure of the shot. **Matrix** averages the entire scene.
- : Change the focus area in auto focus mode. **Multi** focuses on several areas within the frame. Multiple rectangles will appear to indicate the focused areas. **Centre** focuses on the centre within the frame.
- : Create motion panorama photos that can be played as videos. You can view the motion panorama photos at different angles by tilting the device or swiping on the screen.
- : In **FOOD** mode, focus on a subject inside the circular frame and blur the image outside the frame.
- : Activate or deactivate the motion detection feature.
- : Activate or deactivate the Dual capture feature. (Galaxy S9+ models only)

## Camera settings

On the preview screen, tap . Some options may not be available depending on the shooting mode.

### REAR CAMERA

- **Picture size:** Select a resolution for photos. Using a higher resolution will result in higher quality photos, but the files will be larger and require more storage space.

Tap the **Save RAW and JPEG files** switch to set the device to save photos as uncompressed RAW files (DNG file format) in pro mode. RAW files retain all of a photo's data for the best image quality, but they will take up more storage space.



When using this feature, each photo is saved in two formats, DNG and JPG.

- **Video size:** Select a resolution for videos. Using a higher resolution will result in higher quality videos, but they will take up more storage space.

If you activate the **High efficiency video** feature, you can record videos in the High Efficiency Video Codec (HEVC) format. Your HEVC videos will be saved as compressed files to conserve the device's memory.



- You cannot play the HEVC videos on other devices or share them online.
- Super slow motion and slow motion videos cannot be recorded in the HEVC format.

- **Timer:** Select the length of the delay before the camera automatically takes a photo.
- **HDR (rich tone):** Take photos with rich colours and reproduce details even in bright and dark areas.

- **Tracking AF:** Set the device to track and automatically focus on a selected subject. When you select a subject on the preview screen, the device will focus on the subject even if the subject is moving or you change the camera's position.



- When this feature is activated, you cannot use the Video stabilization feature.
- Tracking a subject may fail in the following conditions:
  - The subject is too big or too small.
  - The subject moves excessively.
  - The subject is backlit or you are shooting in a dark place.
  - Colours or patterns on the subject and the background are the same.
  - The subject includes horizontal patterns, such as blinds.
  - The camera shakes excessively.
  - The video resolution is high.
  - When zooming in or out using the 2x optical zoom. (Galaxy S9+ models only)

- **Super slow-mo:** Select how you want to record super slow motion videos.

## FRONT CAMERA

- **Picture size:** Select a resolution for photos. Using a higher resolution will result in higher quality photos, but they will take up more memory.
- **Video size:** Select a resolution for videos. Using a higher resolution will result in higher quality videos, but they will take up more memory.

If you activate the **High efficiency video** feature, you can record videos in the High Efficiency Video Codec (HEVC) format. Your HEVC videos will be saved as compressed files to conserve the device's memory.



You cannot play the HEVC videos on other devices or share them online.

- **Timer:** Select the length of the delay before the camera automatically takes a photo.
- **HDR (rich tone):** Take photos with rich colours and reproduce details even in bright and dark areas.

- **Save pictures as previewed:** Invert the image to create a mirror-image of the original scene, when taking photos with the front camera.
- **Shooting methods:** Select shooting options to use.
- **Face shape correction:** When your face is at the edges of the preview screen, it will appear distorted. Enable this option to correct your face shape. After shape correction, the background may appear slightly distorted.

## COMMON

- **Edit camera modes:** View available shooting modes or edit the shooting modes list.
- **Motion photo:** Set the device to take a video clip for a few seconds before tapping . This allows you to capture a moment you might have missed. To view the video, tap the preview thumbnail and tap **PLAY MOTION PHOTO**. To capture a still image from the video clip, tap the screen to stop playback and tap **CAPTURE**. This feature is available only in **AUTO** and **SELFIE** modes.
- **Video stabilization:** Activate anti-shake to reduce or eliminate blurry image resulting from camera shake while recording a video.



When the **Tracking AF** feature is activated, you cannot use this feature.

- **Grid lines:** Display viewfinder guides to help composition when selecting subjects.
- **Location tags:** Attach a GPS location tag to the photo.



- GPS signal strength may decrease in locations where the signal is obstructed, such as between buildings or in low-lying areas, or in poor weather conditions.
- Your location may appear on your photos when you upload them to the Internet. To avoid this, deactivate the location tag setting.

- **Review pictures:** Set the device to show photos after capturing them.
- **Quick launch:** Set the device to launch the camera by pressing the Power key twice quickly.



This feature may not be available depending on the region or service provider.

- **Storage location:** Select the file storage location. This feature will appear when you insert a memory card.
- **Voice control:** Set the device to take photos or record videos with voice commands. You can say “Smile”, “Cheese”, “Capture”, or “Shoot” to take a photo. To record a video, say “Record video”.
- **Floating Camera button:** Add a camera button that you can place anywhere on the screen.
- **Hold Camera button to:** Select an action to perform when you tap and hold the camera button.
- **Press Volume key to:** Set the device to use the Volume key to control the shutter or zoom in or out.
- **Reset settings:** Reset the camera settings.
- **Contact us:** Ask questions or view frequently asked questions. Refer to [Samsung Members](#) for more information.

## Gallery

### Introduction

View images and videos stored in your device. You can also manage images and videos by album or create stories.

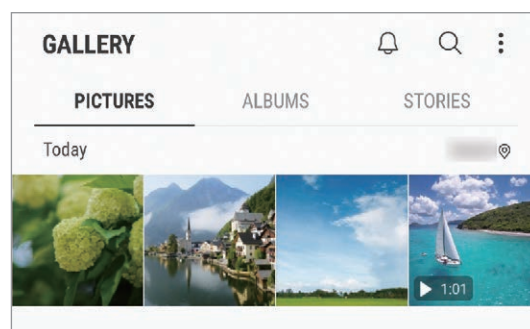



## Viewing images

- 1 Launch the **Gallery** app and tap **PICTURES**.
- 2 Select an image.

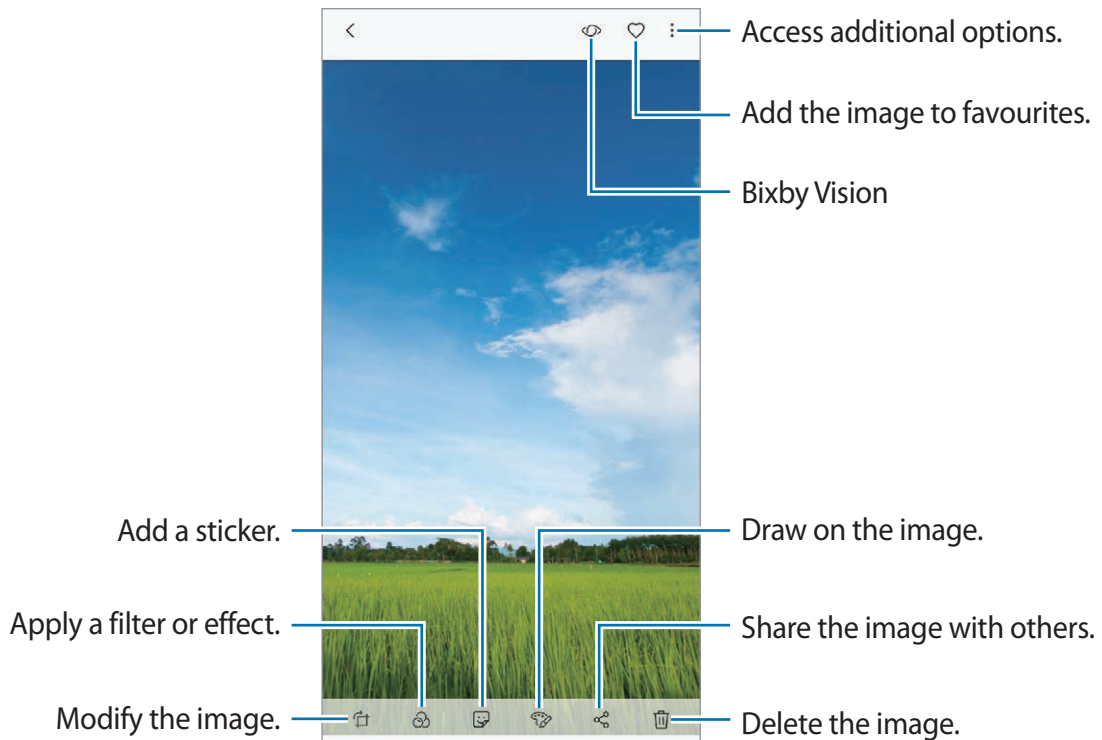

 You can create a movie, animated GIF, or collage from multiple images. On the list, tap **⋮** → **Create new** → **Movie, GIF, or Collage**, and then select images.

## Searching for images

Launch the **Gallery** app and tap **Q** to view images sorted by category, such as types, locations, or documents.

To search for images by entering keywords, tap the search field.

## Editing the background of Live focus photos (Galaxy S9+ models only)

You can edit the background blur level of a photo taken with the Live Focus feature. If the background lighting of Live focus photos appears in blurred points, you can change the shape of the background blur.

Launch the **Gallery** app, select a photo taken with the Live focus feature, tap **ADJUST BACKGROUND BLUR** to edit the blur level or change the shape of the background blur.

## Viewing photos taken with the Dual capture feature (Galaxy S9+ models only)

View the close-up photo and the wide angle photo taken with the Dual capture feature.

Launch the **Gallery** app, select a photo taken with the Dual capture feature, and then tap **WIDE ANGLE** or **CLOSE-UP**.

## Viewing videos

- 1 Launch the **Gallery** app and tap **PICTURES**.
- 2 Select a video to play. Video files show the ▶ icon on the preview thumbnail.
- 3 Tap ▶ to play the video.

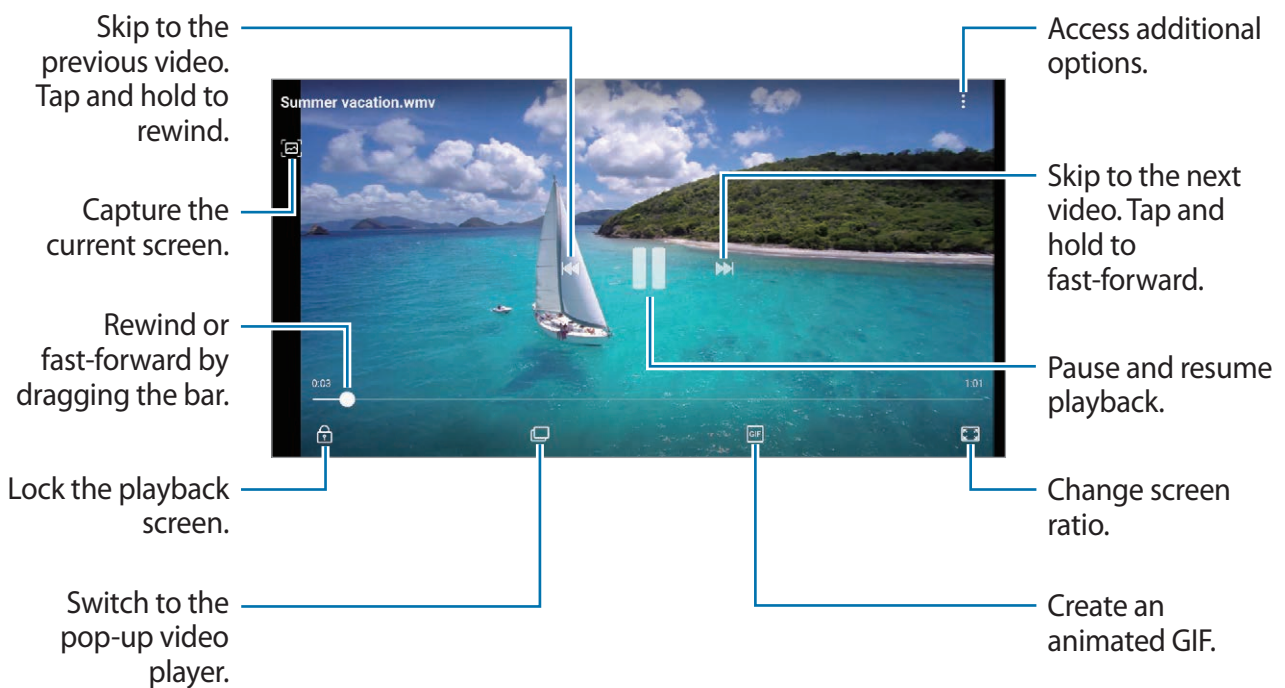

Drag your finger up or down on the left side of the playback screen to adjust the brightness, or drag your finger up or down on the right side of the playback screen to adjust the volume. To rewind or fast-forward, swipe to the left or right on the playback screen.

## Using the Video enhancer feature

Enhance the image quality of your videos to enjoy brighter and more vivid colours. Launch the **Settings** app, tap **Advanced features**, and then tap the **Video enhancer** switch to activate it.



- This feature is only available in some apps.
- Using this feature will increase battery consumption.

## Viewing the details of images and videos

You can view file details, such as people, location, and basic information. If there is auto created content, such as a story or a GIF, the content will also be displayed.

While viewing an image or on the video preview screen, drag upwards on the screen. File details will appear.

You can also view related content by tapping information on the screen.

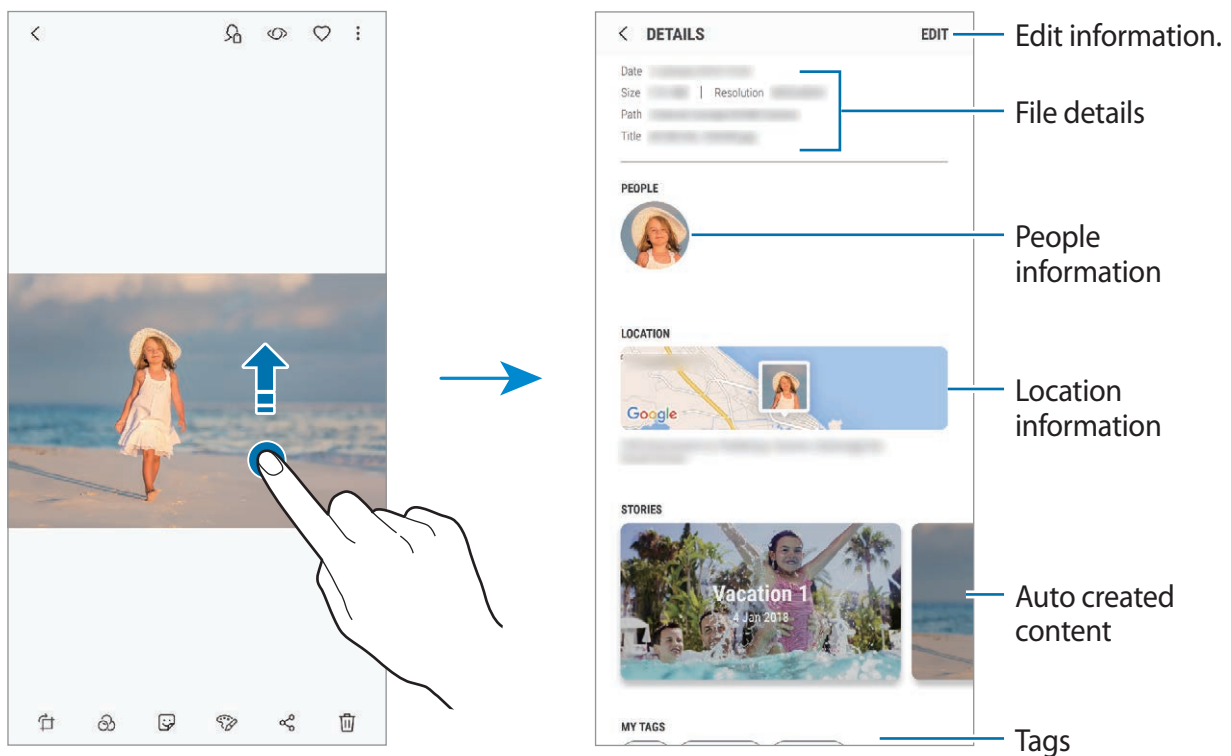

## Viewing albums

You can view your images and videos sorted by folders or albums. The movies, animated GIFs, or collages that you have created will also be sorted in your folders on the albums list.

Launch the **Gallery** app, tap **ALBUMS**, and then select an album.

## Hiding albums

You can hide albums.



You cannot hide albums created by default, such as the **Camera** and **Screenshots** albums.

1 Launch the **Gallery** app and tap **ALBUMS**.

2 Tap  → **Hide or unhide albums**.

3 Select albums to hide and tap **APPLY**.

To show albums again, tap  → **Hide or unhide albums**, deselect albums to show, and then tap **APPLY**.

## Viewing stories

When you capture or save images and videos, the device will read their date and location tags, sort the images and videos, and then create stories. To create stories automatically, you must capture or save multiple images and videos.

Launch the **Gallery** app, tap **STORIES**, and then select a story.

## Creating stories

Create stories with various themes.



1 Launch the **Gallery** app and tap **STORIES**.

2 Tap  → **Create story**.

3 Tick images or videos to include in the story and tap **DONE**.

4 Enter a title for the story and tap **CREATE**.

To add images or videos to a story, select a story and tap **ADD**.

To remove images or videos from a story, select a story, tap  → **Edit**, tick images or videos to remove, and then tap  → **Remove from story**.

## Deleting stories

1 Launch the **Gallery** app and tap **STORIES**.

2 Tap and hold a story to delete, and tap **DELETE**.

## Syncing images and videos with Samsung Cloud

You can sync images and videos saved in **Gallery** with Samsung Cloud and access them from other devices. You must register and sign in to your Samsung account to use Samsung Cloud. Refer to [Samsung account](#) for more information.

Launch the **Gallery** app, tap  → **Settings**, and then tap the **Samsung Cloud** switch to activate it. Images and videos captured on the device will be automatically saved to Samsung Cloud.

## Deleting images or videos

### Deleting an image or a video

Select an image or a video and tap  at the bottom of the screen.

### Deleting multiple images and videos

1 On the Gallery screen, tap and hold an image or a video to delete.

2 Tick the images or videos to delete.

3 Tap **DELETE**.

## Always On Display

You can always view information, such as the clock or calendar, or control music playback on the screen when it is turned off.

You can also check notifications for new messages or missed calls.



- The brightness of the Always On Display may change automatically depending on the lighting conditions.
- If the sensor at the top of the device is covered for a certain period, the Always On Display will turn off.

### Opening notifications on the Always On Display

When you receive message, missed call, or app notifications, notification icons will appear on the Always On Display. Double-tap a notification icon to view its notification.

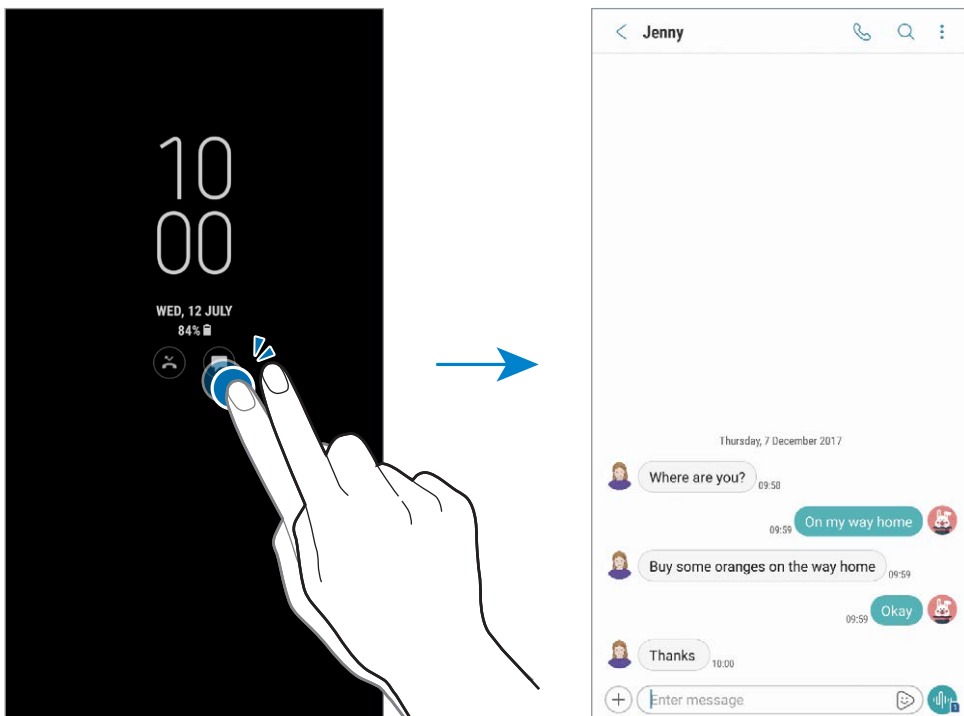

If the screen is locked, you must unlock it to view notifications.

## Controlling music playback on the Always On Display

You can control music playback on the Always On Display, without turning on the screen.

- 1 Launch the **Settings** app, tap **Lock screen and security** → **Clock and FaceWidgets** → **FaceWidgets**, and then tap the **Music Controller** switch to activate it.
- 2 To control music playback on the Always On Display, double-tap the clock.
- 3 Swipe to the left or right on the clock to move to the music controller.
- 4 Tap the icons to control the playback.

## Displaying an image to the Always On Display

You can display an image on the Always On Display. You can also display an animated GIF.

- 1 Launch the **Settings** app → **Lock screen and security** → **Clock and FaceWidgets** → **Clock style**.
- 2 Drag the types list to the left and select the icon with an image on it.
- 3 Tap **+** and select an image.  
To insert an animated GIF, tap **Add GIF** and select a file.
- 4 Tap **APPLY**.

## Changing the schedule for the Always On Display feature

Launch the **Settings** app, tap **Lock screen and security** → **Always On Display** → **Set schedule** and set the start and end time.

To always display the Always On Display, tap the **Show always** switch to activate it.

## Deactivating the Always On Display feature

Launch the **Settings** app, tap **Lock screen and security**, and then tap the **Always On Display** switch to deactivate it.

# Edge screen

## Introduction

You can quickly access your favourite apps, features, and contacts from various Edge panels.

## Using the Edge panels

Drag the Edge panel handle towards the centre of the screen. Then, swipe to the left or right to switch between the Edge panels. Alternatively, tap  and select the panel you want.



If the Edge panel handle is not visible, launch the **Settings** app, tap **Display** → **Edge screen**, and then tap the **Edge panels** switch to activate it.







## Editing the Edge panels

Select panels to display on the Edge screen or edit them.

- 1 Drag the Edge panel handle towards the centre of the screen.
- 2 Tap  to open the Edge panel settings screen.
- 3 Tick Edge panels to display.  
To edit a panel, tap **EDIT**.  
To download additional panels, tap **DOWNLOAD**.  
To rearrange panels, tap  → **Reorder** and drag  to another location.

## Setting the Edge panel handle

You can change the location, size, transparency, or vibration settings of the handle.



Drag the Edge panel handle towards the centre of the screen. Then, tap  →  → **Edge panel handle**.

## Apps edge

Quickly launch frequently used apps.

- 1 Drag the Edge panel handle towards the centre of the screen.
- 2 Swipe to the left or right to open the Apps edge panel. Alternatively, tap  → **Apps edge**.
- 3 Select an app to launch it.

## Editing the Apps edge panel

- To add an app, tap  on the panel and tap an app from the apps list.
- To create a folder on the panel, tap  on the panel, tap and hold an app from the apps list, and then drag it over another app on the Apps edge panel. Drop the app when a folder frame appears around the apps.
- To delete an app, tap and hold an app on the panel and drag it to **Remove** at the top of the panel.
- To change the order of apps, tap and hold an app and drag it to another location.



You can also edit the Apps edge panel by tapping **EDIT**.

## People edge

Add favourite contacts to the People edge panel to quickly contact them and view notifications received from them.

- 1 Drag the Edge panel handle towards the centre of the screen.
- 2 Swipe to the left or right to open the People edge panel. Alternative, tap  → **People edge**.

## Adding contacts to the People edge panel

Add frequently used contacts to the People edge panel and set them as your priority contacts.

Tap  and select a contact from your favourites list, or tap **SELECT CONTACTS**, select contacts, and then tap **DONE**.



Only contacts saved in **Contacts** can be added to the People edge panel.

## Editing the People edge panel

- To delete a contact, tap and hold a contact icon and drag it to **Remove** at the top of the screen.
- To change the order of contacts, tap and hold a contact icon and drag it to another location.



You can also edit the People edge panel by tapping **EDIT**.

## Contacting people from the People edge panel

Open the People edge panel and tap a contact. The communication buttons will appear on the screen. Tap the desired button to call or send a message to the contact.



## Smart select

Select an area to capture it as an image or a GIF animation. You can also pin an image so that it is always displayed at the top of the list.

### Capturing an image

- 1 Drag the Edge panel handle towards the centre of the screen.
- 2 Swipe to the left or right to open the Smart select panel. Alternative, tap  → **Smart select**.
- 3 Select a desired shape icon on the panel.
- 4 Drag the frame on the content you want to select.  
To resize the frame, drag a corner of the frame.
- 5 Tap **DONE**.  
If text is included in the selected area, tap **Extract text** to recognize and extract text from the selected area.
- 6 Select an option to use with the selected area.
  - **Bixby Vision**: Recognize content using Bixby Vision and search for relevant information.
  - **Draw**: Write or draw on the selected area.
  - **Share**: Share the selected area with others.
  - **Set as**: Set the selected area to be displayed when the screen is off.
  - **Save**: Save the selected area in **Gallery**.

## Capturing an area from a video

While playing a video, select an area and capture it as a GIF animation.

- 1 When there is content you want to capture during video playback, drag the Edge panel handle towards the centre of the screen.
- 2 Swipe to the left or right to open the Smart select panel. Alternative, tap  → **Smart select**.
- 3 On the panel, tap **Animation**.
- 4 Adjust the position and size of the capturing area.

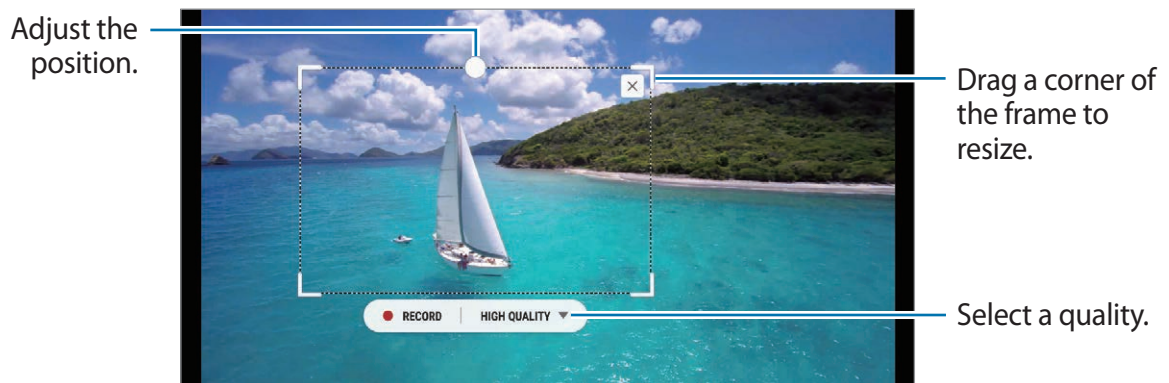

- 5 Tap **RECORD** to start capturing.



- Before capturing a video, make sure that the video is playing.
- The maximum duration you can capture an area of the video for will be displayed on the screen.
- When capturing an area from a video, its sound will not be recorded.

- 6 Tap **STOP** to stop capturing.

- 7 Select an option to use with the selected area.

- **Draw:** Write or draw on the selected area. Tap **Preview** to view the result before saving the file.
- **Share:** Share the selected area with others.
- **Save:** Save the selected area in **Gallery**.

## Edge lighting

You can set the device to light up the edges of the screen and display a pop-up window when you receive notifications, such as new messages.

Even while the device's screen is facing downwards, the edges of the screen will light up to notify you of a call or new notifications. When a pop-up window appears while using an app, drag the window downwards to quickly view the content and perform available actions.

### Managing notifications to display as the edge lighting

- 1 Launch the **Settings** app, tap **Display** → **Edge screen** → **Edge lighting**.
- 2 Tap **Manage notifications** and tap the switches next to apps to receive notifications as the edge lighting.



Some notifications may not display as the edge lighting depending on notification types.

### Quick reply

You can reject incoming calls using custom rejection messages. While the device's screen is facing downwards, hold your finger on the heart rate sensor on the back of the device for two seconds to reject calls.

To edit the default rejection message, launch the **Settings** app, tap **Display** → **Edge screen** → **Edge lighting** →  → **Quick reply**, and then tap the message text under **QUICK REPLY MESSAGE**.

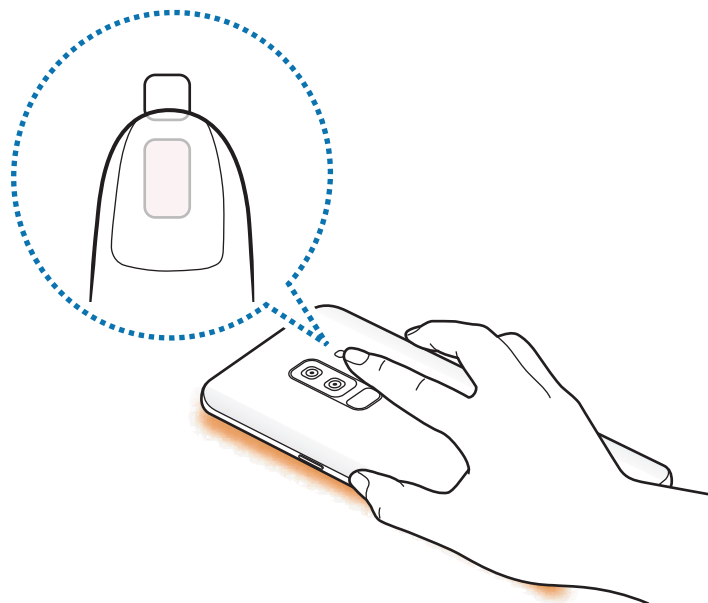

# Multi window

## Introduction

Multi window lets you run two apps at the same time in the split screen view. You can also run multiple apps at the same time in the pop-up view.



Some apps may not support this feature.

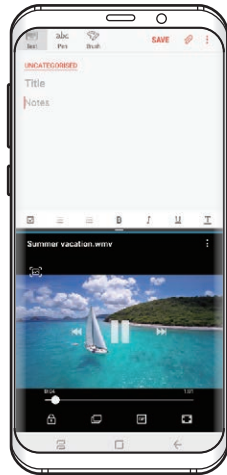

Split screen view

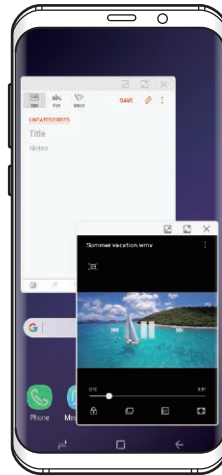

Pop-up view

## Split screen view

- 1 Tap the Recents button to open the list of recently used apps.
- 2 Swipe upwards or downwards and tap  on a recent app window.  
The selected app will launch in the upper window.

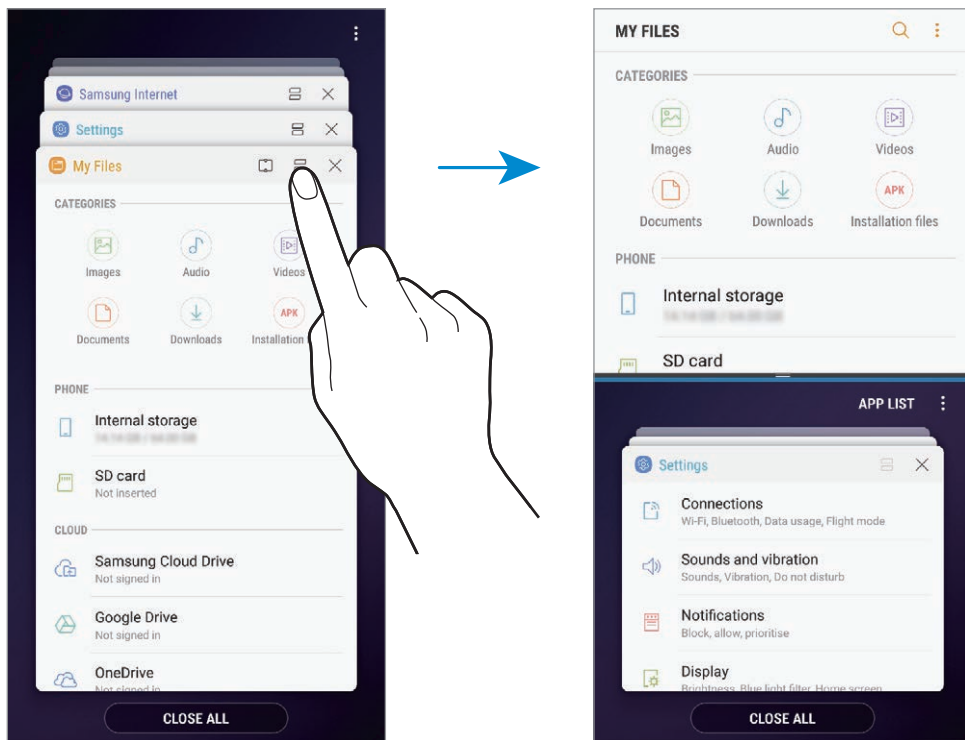

- 3 In the lower window, swipe upwards or downwards to select another app to launch.  
To launch apps not in the list of recently used apps, tap **APP LIST** and select an app.



## Using additional options

Tap the bar between the app windows to access additional options.

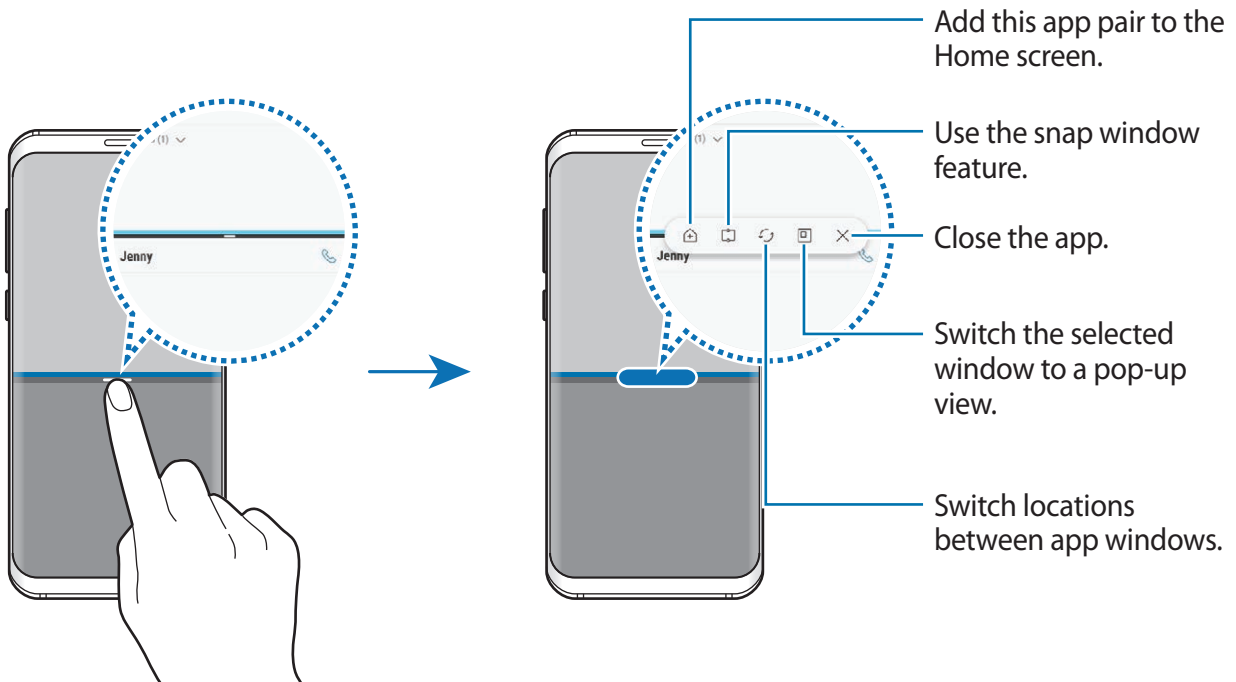

## Adjusting the window size

Drag the bar between the app windows up or down to adjust the size of the windows.

When you drag the bar between the app windows to the top or bottom edge of the screen, the window will be maximized.

## Minimizing the split screen view

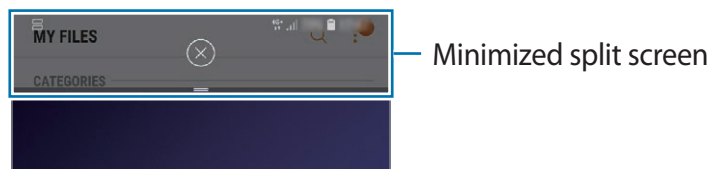

Press the Home button to minimize the split screen view. The  icon will appear on the status bar. The app in the lower window will close and the app in the upper window will remain active in the minimized split screen view.



To close the minimized split screen view, tap .

## Snap window

You can select an area and pin it to the top of the screen and use other apps in the lower window.

- 1 Tap the Recents button to open the list of recently used apps.
- 2 Tap  and drag the frame to the area you want to pin it to.  
To adjust the size of the frame, drag  upwards or downwards.
- 3 Tap **DONE**.  
The selected app window will be pinned at the top of the screen. To unpin the window, drag the bar between the app windows.
- 4 In the lower window, swipe upwards or downwards to select another app to launch.

## Adding app pairs to the Home screen

When you add app pairs to the Home screen, you can launch two apps in the split screen view with a single tap.

Tap the bar between the app windows and tap .

The current app pair will be added on the Home screen.

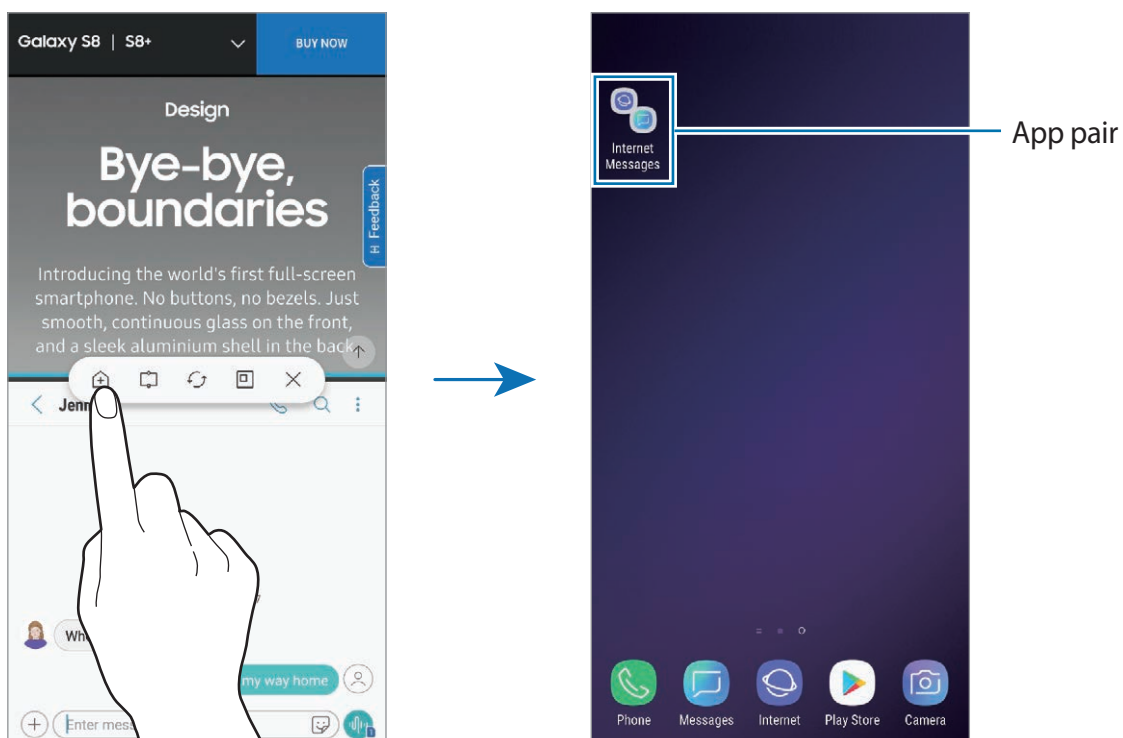

## Pop-up view

- 1 Tap the Recents button to open the list of recently used apps.
- 2 Swipe upwards or downwards, tap and hold an app window, and then drag it to **Drop here for pop-up view**.

The app screen will appear in the pop-up view.

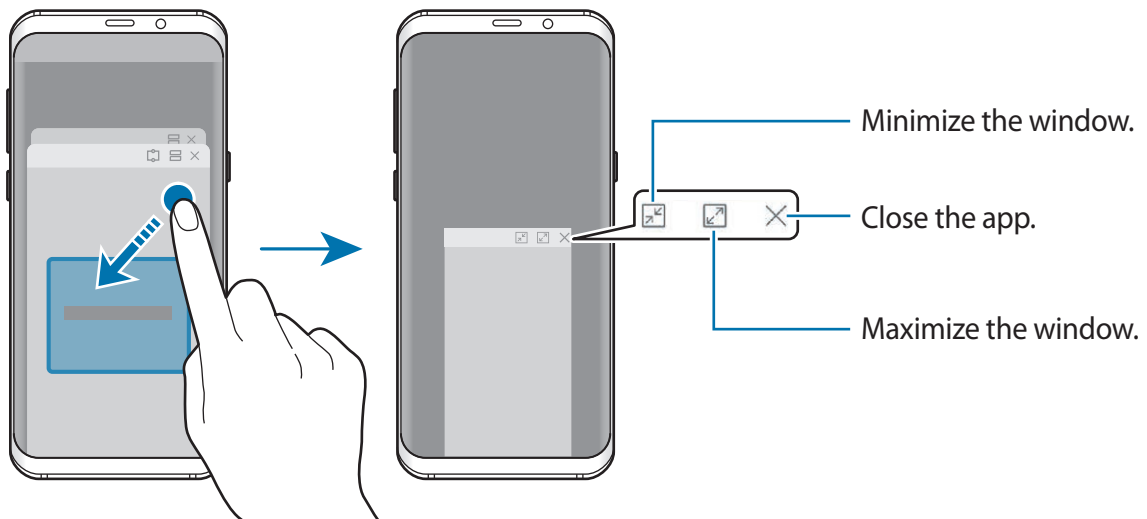

## Moving pop-up windows

To move a pop-up window, tap the window's toolbar and drag it to a new location.

## Notification pop-up windows

You can quickly view the content of a notification and perform available actions from the notification pop-up window. For example, if you receive a message while watching a video or playing a game, you can view the message and reply to it without switching the screen.

When a notification pop-up window appears, drag it downwards to view the content.

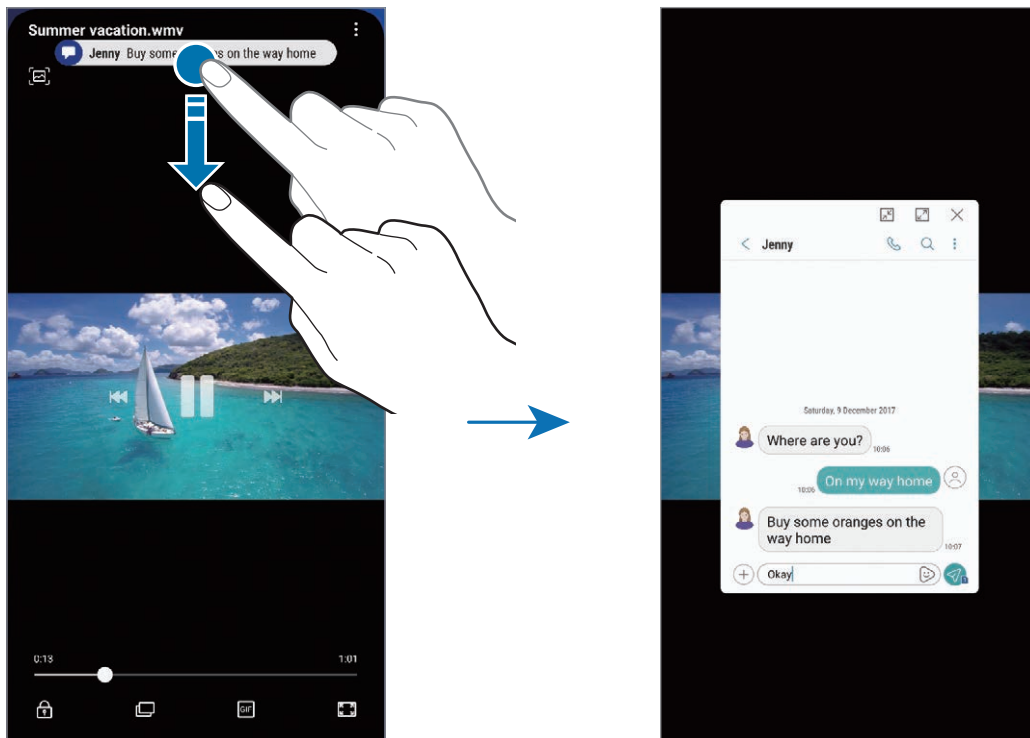

This feature is only available to apps that support the Multi window and edge lighting features. To view supported apps, launch the **Settings** app, tap **Display** → **Edge screen** → **Edge lighting** → **Manage notifications**.

# Samsung Pay

## Introduction

Register frequently used cards to Samsung Pay, a mobile payment service, to make payments quickly and securely. Samsung Pay supports magnetic secure transmission (MST) as well as near field communication (NFC) to allow payment through standard credit card readers.

You can view more information, such as cards that support this feature at [www.samsung.com/samsungpay](http://www.samsung.com/samsungpay). Alternatively, launch the **Samsung Pay** app and tap  → **Help**.



- To use this feature, you must sign in to your Samsung account and register your biometric data. For more information, refer to [Samsung account](#), [Fingerprint recognition](#), and [Iris recognition](#).
- To make payments with Samsung Pay, the device may be required a connection to a Wi-Fi or mobile network depending on the region.
- This app's availability and supported features may vary depending on the region or service provider.
- The procedures for the initial setup and card registration may vary depending on the region or service provider.

## Setting up Samsung Pay

When running this app for the first time or restarting it after performing a data reset, follow the on-screen instructions to complete the initial setup.

- 1 Launch the **Samsung Pay** app.
- 2 Sign in to your Samsung account.
- 3 Read and agree to the terms and conditions.
- 4 Register your fingerprint or irises to use when making payments.
- 5 Create a PIN to use when making payments.



This PIN will be used to verify various actions in Samsung Pay, such as making payments and unlocking the app.

## Registering cards

You can easily register cards by capturing their images with the camera.



You can check the cards that support this feature from the Samsung Pay website ([www.samsung.com/samsungpay](http://www.samsung.com/samsungpay)).

Launch the **Samsung Pay** app, tap **ACTIVATE CARD**, and then follow the on-screen instructions to complete your card registration.

## Making payments

- 1 Tap and hold a card image at the bottom of the screen and drag it upwards. Alternatively, launch the **Samsung Pay** app.

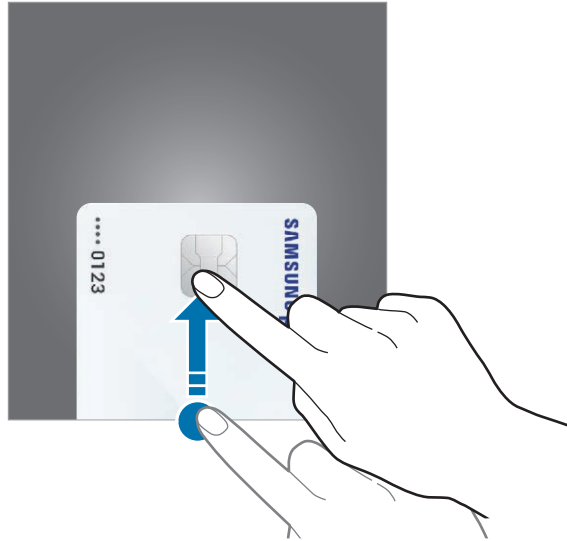

- 2 On the cards list, swipe to the left or right and select a card to use.

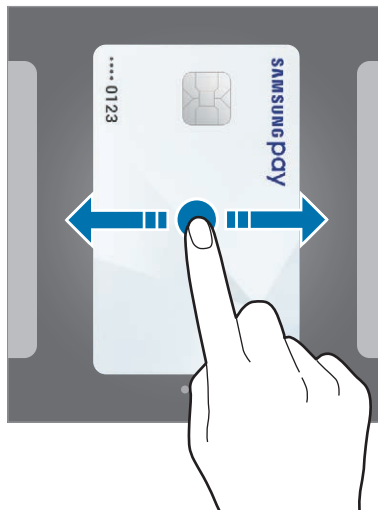

### 3 Scan your fingerprint or irises.

Alternatively, enter the payment PIN you set when setting up the Samsung Pay.

### 4 Touch the back of your device to the card reader.

When the card reader recognizes the card information, the payment will be processed.



- Payments may not be processed depending on your network connection.
- The verification method for payments may vary depending on the card readers.

## Cancelling payments

You can cancel payments by visiting the place where you made them.

On the cards list, swipe to the left or right to select the card you used. Follow the on-screen instructions to complete payment cancellation.

## Changing the Samsung Pay settings

On the Samsung Pay screen, tap  → **Settings**. Select the screen where the card image will appear to activate Samsung Pay on the Home screen or locked screen, or when the screen is turned off.

## Samsung Gear

Samsung Gear is an app that allows you to manage your Gear wearable device. When you connect your device to the Gear, you can customize the Gear's settings and apps.

Open the **Samsung** folder and launch the **Samsung Gear** app.

Tap **START THE JOURNEY** to connect your device to the Gear. Follow the on-screen instructions to finish the setup. Refer to the Gear's user manual for more information about how to connect and use the Gear with your device.



## Samsung Members

**Samsung Members** offers support services to customers, such as device problem diagnosis, and lets users submit questions and error reports. You can also share information with others in the Galaxy users' community or view the latest Galaxy news and tips. **Samsung Members** can help you solve any problems you might encounter while using your device.

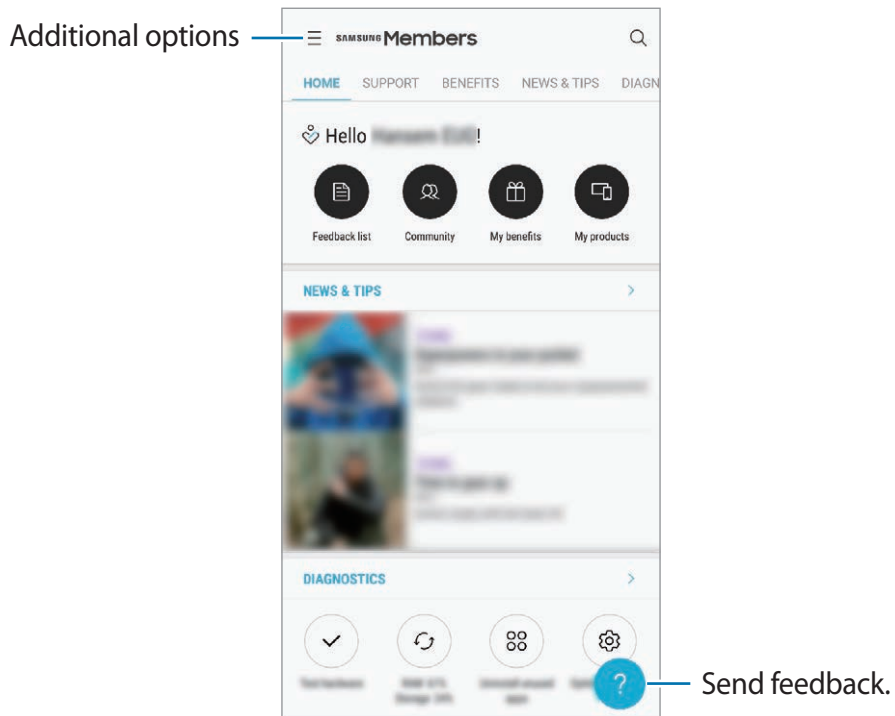



- This app's availability and supported features may vary depending on the region or service provider.
- To submit your feedback or post your comments, you must register and sign in to your Samsung account. Refer to [Samsung account](#) for more information.

# Samsung Notes

Create notes by entering text from the keyboard or by hand writing or drawing on the screen. You can also insert images or voice recordings into your notes.

## Creating notes

- 1 Launch the **Samsung Notes** app and tap **ALL** → .
- 2 Select an input method from the toolbar at the top of the screen and compose a note.  
Tap  → **Image** to insert an image by selecting from **Gallery** or by taking a photo.  
Tap  → **Voice** to record a voice recording and insert it into the note. Voice recording will start immediately.

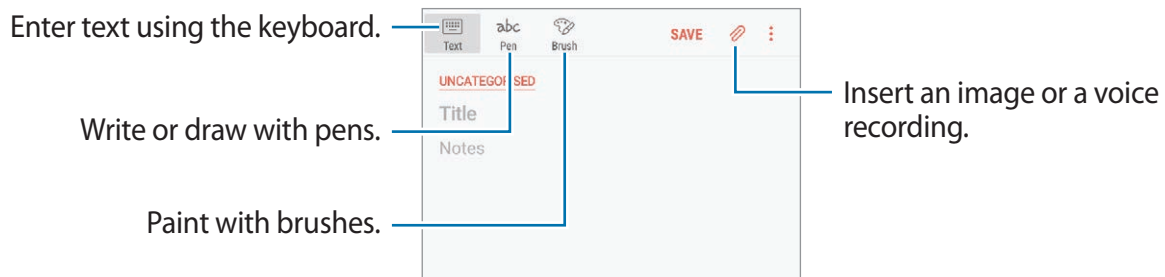

- 3 When you are finished composing the note, tap **SAVE**.



## Deleting notes

- 1 Launch the **Samsung Notes** app, tap **ALL** or tap **COLLECTIONS** and select a category.
- 2 Tap and hold a note to delete.  
To delete multiple notes, tick more notes to delete.
- 3 Tap .

# Calendar

Manage your schedule by entering upcoming events or tasks in your planner.

## Creating events

- 1 Launch the **Calendar** app and tap  or double-tap a date.  
If the date already has saved events or tasks in it, tap the date and tap .

- 2 Enter event details.

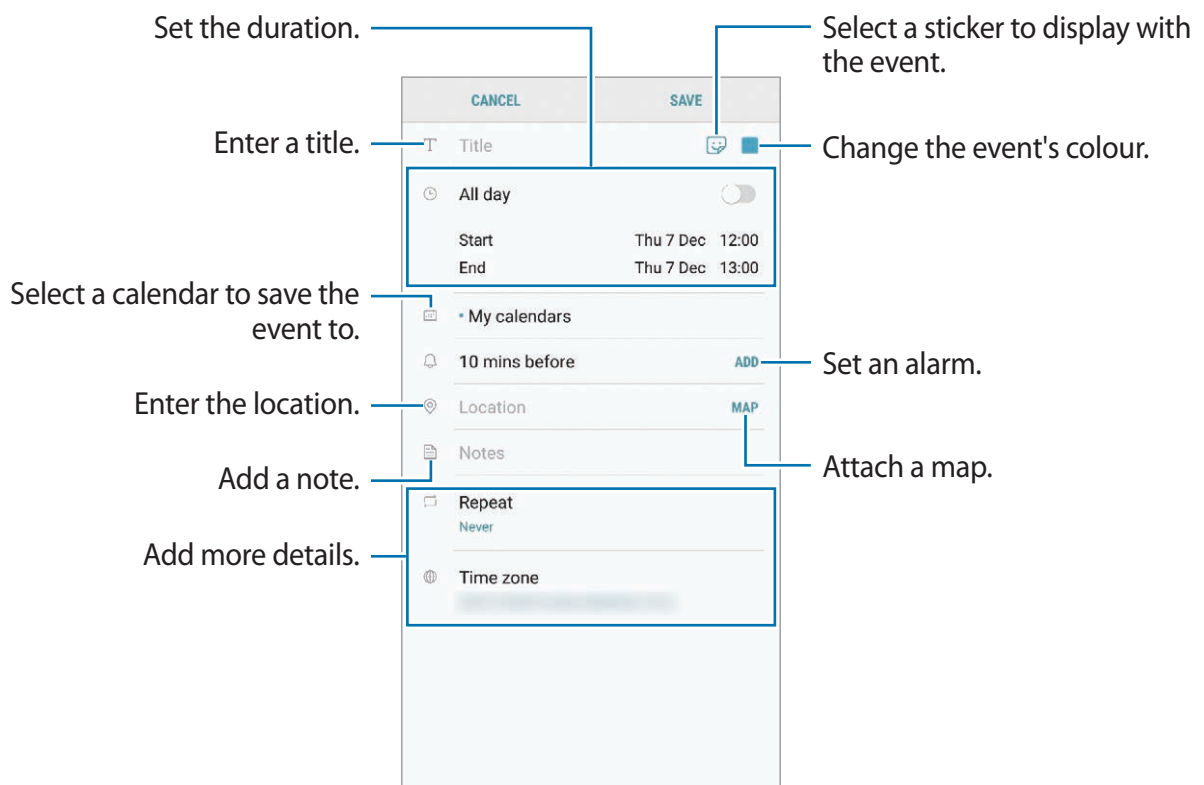

- 3 Tap **SAVE** to save the event.

## Creating tasks

- 1 Launch the **Calendar** app and tap **VIEW** → **Tasks**.
- 2 Tap **+** and enter task details.
- 3 Tap **SAVE** to save the task.

## Syncing events and tasks with your accounts

- 1 Launch the **Settings** app, tap **Cloud and accounts** → **Accounts** and select the account to sync with.
- 2 Tap **Sync account** and tap the **Sync Calendar** switch to activate it.  
For the Samsung account, tap **⋮** → **Sync settings** and tap the **Calendar** switch to activate it.

To add accounts to sync with, launch the **Calendar** app and tap **⋮** → **Manage calendars** → **Add account**. Then, select an account to sync with and sign in. When an account is added, it will appear on the list.

# Samsung Health

## Introduction

Samsung Health helps you manage your wellness and fitness. Set fitness goals, check your progress, and keep track of your overall wellness and fitness.

## Using Samsung Health

You can view the key information from Samsung Health menus and trackers to monitor your wellness and fitness. You can also compare your step count records with other Samsung Health users, compete with your friends, and view health tips.

Open the **Samsung** folder and launch the **Samsung Health** app. When running this app for the first time or restart it after performing a data reset, follow the on-screen instructions to complete the setup.



Some features may not be available depending on the region.

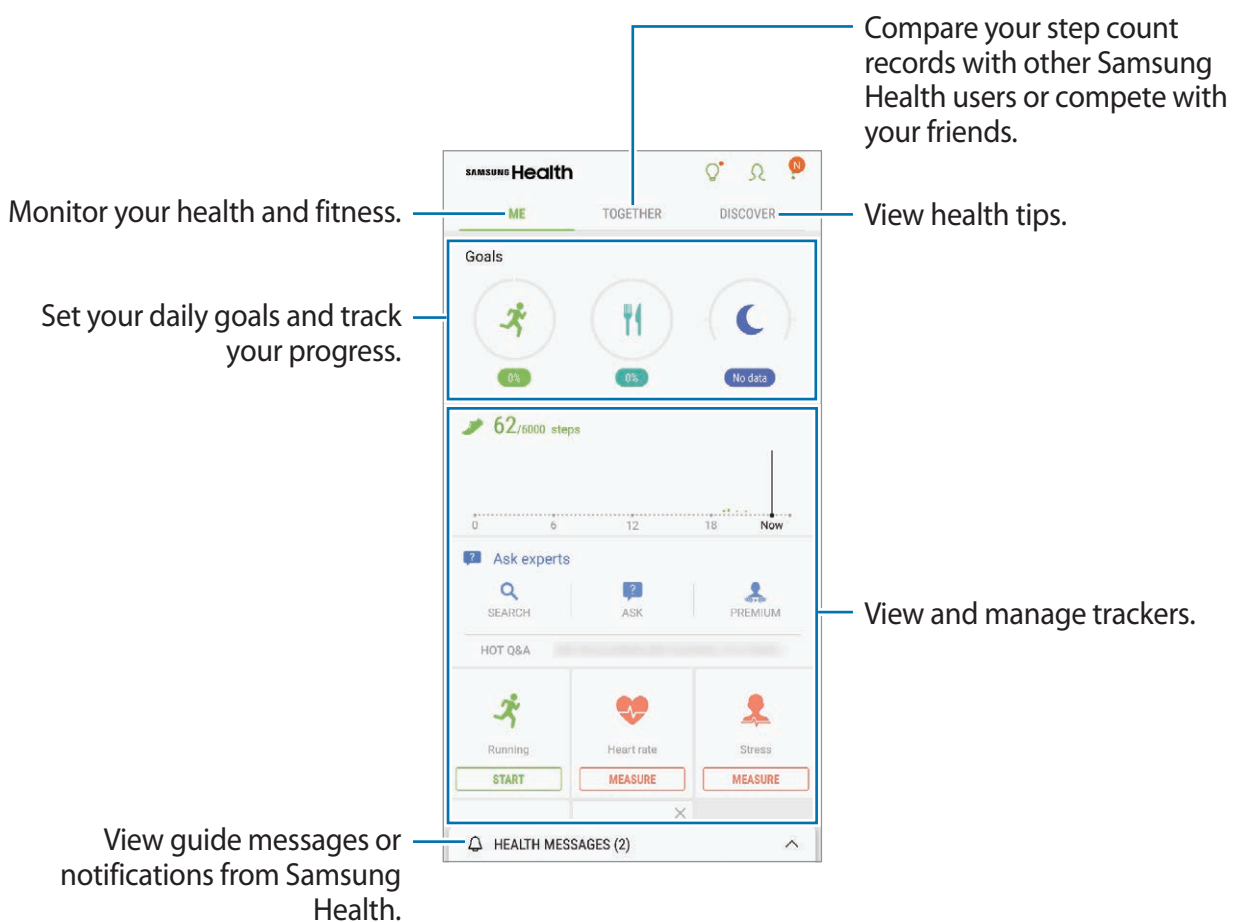

To add items to the Samsung Health screen, tap  → **Manage items**, and then select items.

- **GOALS:** Set your daily fitness goals and view your progress.
- **PROGRAMS:** Use customizable exercise programs.
- **GENERAL TRACKERS:** Monitor your activities, food intake, and body measurements.
- **EXERCISE TRACKERS:** Add trackers of various exercises and monitor your activities.

## Goals

You can set your goals for weight management or a more balanced life. After setting your goals, you can track your progress or view guides on the Samsung Health screen.

On the Samsung Health screen, tap **SET GOALS**. Alternatively, tap  → **Manage items** and select **Weight management** or **Balanced life**.

## TOGETHER

Together allows you to set up step count goals and compete with your friends. You can invite friends to walk together, set target step counts, compete in challenges, and view your ranking on the **Steps leaderboard**.

On the Samsung Health screen, tap **TOGETHER**.

## Steps

The device counts the number of steps you take and measures the distance travelled.

On the Samsung Health screen, tap the steps tracker.

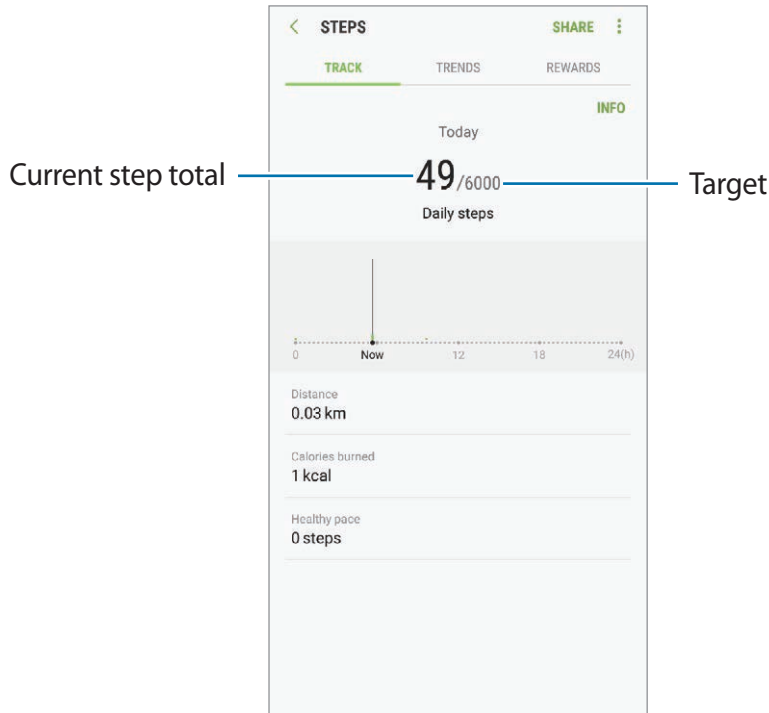

- You may experience a brief delay while the steps tracker monitors your steps and then displays your step count. You may also experience a brief delay before the pop-up window indicates that your goal has been reached.
- If you use the steps tracker while travelling by car or train, vibration may affect your step count.

## Heart rate

Measure and record your heart rate.



The heart rate tracker is intended for fitness and informational purposes only and is not intended for use in the diagnosis of disease or other conditions, or in the cure, mitigation, treatment, or prevention of disease.

### **Be aware of following conditions before measuring your heart rate:**

- Rest for 5 minutes before taking measurements.
- If the measurement is very different from the expected heart rate, rest for 30 minutes and then measure it again.
- During winter or in cold weather, keep yourself warm when measuring your heart rate.
- Smoking or consuming alcohol before taking measurements may cause your heart rate to be different from your normal heart rate.
- Do not talk, yawn, or breathe deeply while taking heart rate measurements. Doing so may cause your heart rate to be recorded inaccurately.
- Heart rate measurements may vary depending on the measurement method and the environment they are taken in.
- If the heart rate sensor is not working, make sure nothing is obstructing the sensor. If the heart rate sensor continues to have the same problem, visit a Samsung Service Centre.



- 1 On the Samsung Health screen, tap the heart rate tracker and tap **MEASURE** to start measuring your heart rate.
- 2 Place your finger on the heart rate sensor on the back of the device.

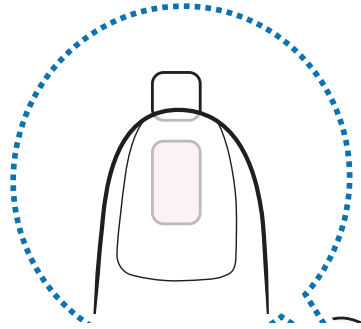

- 3 After a moment, your current heart rate will be displayed on the screen. Remove your finger from the sensor.

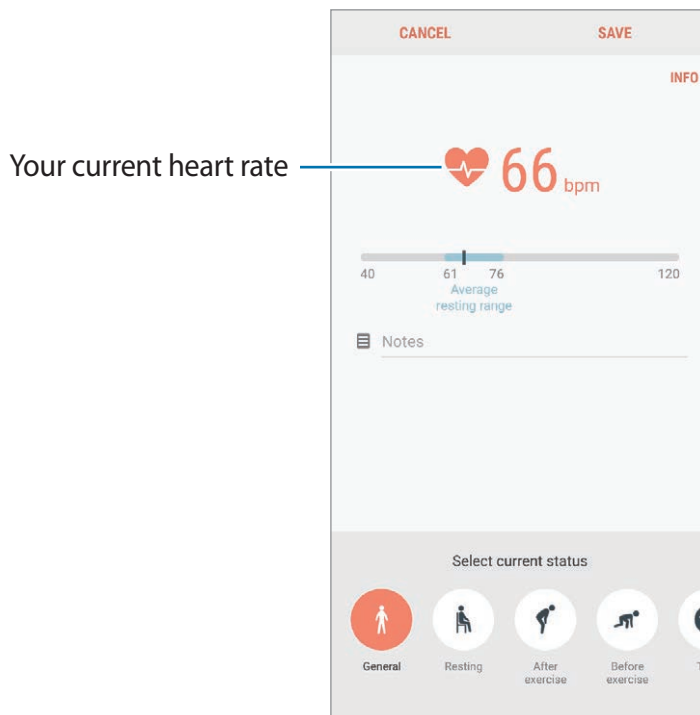

## Additional information



- Samsung Health is intended for fitness and wellness purposes only and is not intended for use in the diagnosis of disease or other conditions, or in the cure, mitigation, treatment, or prevention of disease.
- The available functions, features and addable applications for Samsung Health may vary from country to country due to different local laws and regulations. You should check the features and applications available in your specific region before use.
- Samsung Health applications and its service can be changed or discontinued without prior notice.
- The purpose for data collection is limited to providing the service that you have requested, including providing additional information to enhance your wellness, sync data, data analysis and statistics or to develop and provide better services. (But if you sign in to your Samsung account from Samsung Health, your data may be saved on the server for data backup purposes.) Personal information may be stored until the completion of such purposes. You can delete personal data stored by Samsung Health by using the Reset data option in the Settings menu. To delete any data you have shared with social networks or transferred to storage devices, you must delete them separately.
- You may share and/or sync your data with additional Samsung services or compatible third party services that you select, as well as with any of your other connected devices. Access to Samsung Health information by such additional services or third party devices will only be permitted with your express approval.
- You assume full responsibility for the inappropriate use of data shared on social networks or transmitted to others. Use caution when sharing your personal data with others.
- If the device is connected to measuring devices, verify the communication protocol to confirm proper operation. If you use a wireless connection, such as Bluetooth, the device may be affected by electronic interference from other devices. Avoid using the device near other devices that transmit radio waves.
- Please read Terms and Conditions and Privacy Policy of Samsung Health carefully before using it.

# Voice Recorder

## Introduction

Use different recording modes for various situations. The device can convert your voice to text and distinguish between sound sources.

## Making voice recordings

- 1 Open the **Samsung** folder and launch the **Voice Recorder** app.
- 2 Tap  to start recording. Speak into the microphone.  
Tap  to pause recording.  
While making a voice recording, tap **BOOKMARK** to insert a bookmark.

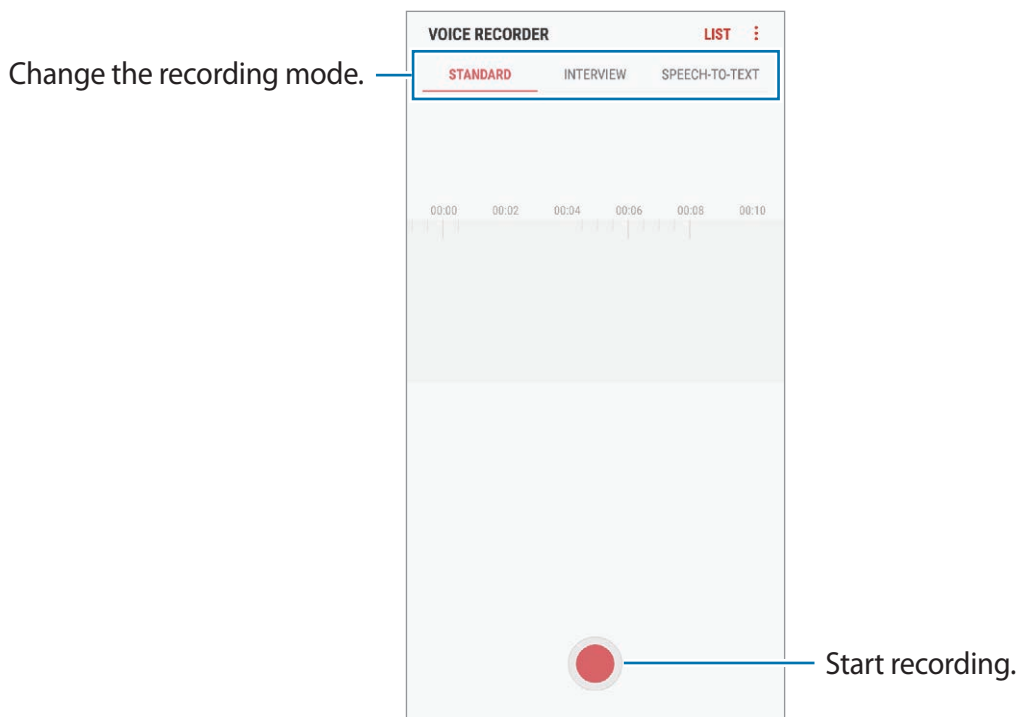

- 3 Tap  to finish recording.
- 4 Enter a file name and tap **SAVE**.

## Changing the recording mode

Open the **Samsung** folder and launch the **Voice Recorder** app.

Select a mode from the top of the voice recorder screen.

- **STANDARD:** This is the normal recording mode.
- **INTERVIEW:** The microphone is sensitive to sounds from two directions. In this mode, both the top and the bottom of the device pick up sound.
- **SPEECH-TO-TEXT:** The device records your voice and simultaneously converts it to on-screen text. For best results, keep the device near your mouth and speak loudly and clearly in a quiet place.



If the voice memo system language does not match the language you are speaking, the device will not recognize your voice. Before using this feature, tap the current language to set the voice memo system language.

## Playing selected voice recordings

When you review interview recordings, you can mute or unmute certain sound sources in the recording.

- 1 Open the **Samsung** folder and launch the **Voice Recorder** app.
- 2 Tap **LIST** and select a voice recording made in interview mode.
- 3 To mute certain sound sources, tap **ON** for the corresponding direction that sound is to be muted.

The icon will change to **OFF** and the sound will be muted.

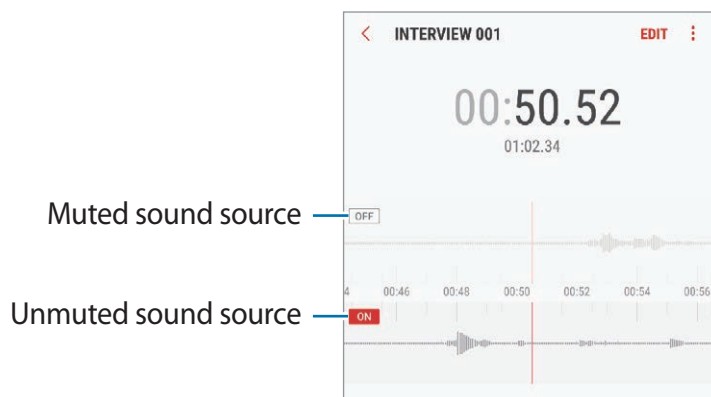

## My Files

Access and manage various files stored in the device or in other locations, such as cloud storage services.

Open the **Samsung** folder and launch the **My Files** app.

View files that are stored in each storage.

To free up the device's storage, tap  → **Get more space**.

To search for files or folders, tap .

## Clock

### Introduction

Set alarms, check the current time in many cities around the world, time an event, or set a specific duration.

### ALARM

Launch the **Clock** app and tap **ALARM**.

### Setting alarms

Tap  in the alarms list, set an alarm time, select the days on which the alarm will repeat, set other various alarm options, and then tap **SAVE**.

To open the keypad to enter an alarm time, tap the time input field.

To activate or deactivate alarms, tap the switch next to the alarm in the alarms list.

### Stopping alarms

Tap **DISMISS** to stop an alarm. If you have previously enabled the snooze option, tap **SNOOZE** to repeat the alarm after a specified length of time.

## Deleting alarms

Tap and hold an alarm, tick alarms to delete, and then tap **DELETE**.

## WORLD CLOCK

Launch the **Clock** app and tap **WORLD CLOCK**.

## Creating clocks

Tap , enter a city name or select a city from the globe, and then tap **ADD**.

## Deleting clocks

Tap and hold a clock, tick clocks to delete, and then tap **DELETE**.

## STOPWATCH

- 1 Launch the **Clock** app and tap **STOPWATCH**.
- 2 Tap **START** to time an event.  
To record lap times while timing an event, tap **LAP**.
- 3 Tap **STOP** to stop timing.  
To restart the timing, tap **RESUME**.  
To clear all time measurements, tap **RESET**.

## TIMER

- 1 Launch the **Clock** app and tap **TIMER**.
- 2 Set the duration, and then tap **START**.  
To open the keypad to enter the duration, tap the duration input field.
- 3 Tap **DISMISS** when the timer goes off.

## Calculator

Perform simple or complex calculations.

Launch the **Calculator** app.

Rotate the device to landscape orientation to display the scientific calculator. If **Auto-rotate** is disabled, tap  to display the scientific calculator.

To see the calculation history, tap **HISTORY**. To close the calculation history panel, tap **KEYPAD**.

To clear the history, tap **HISTORY** → **CLEAR HISTORY**.

To use the unit conversion tool, tap . You can convert various values, such as area, length, or temperature, into other units.

## Game Launcher

### Introduction

Game Launcher gathers your games downloaded from **Play Store** and **Galaxy Apps** into one place for easy access. You can set the device to game mode to play games more easily.

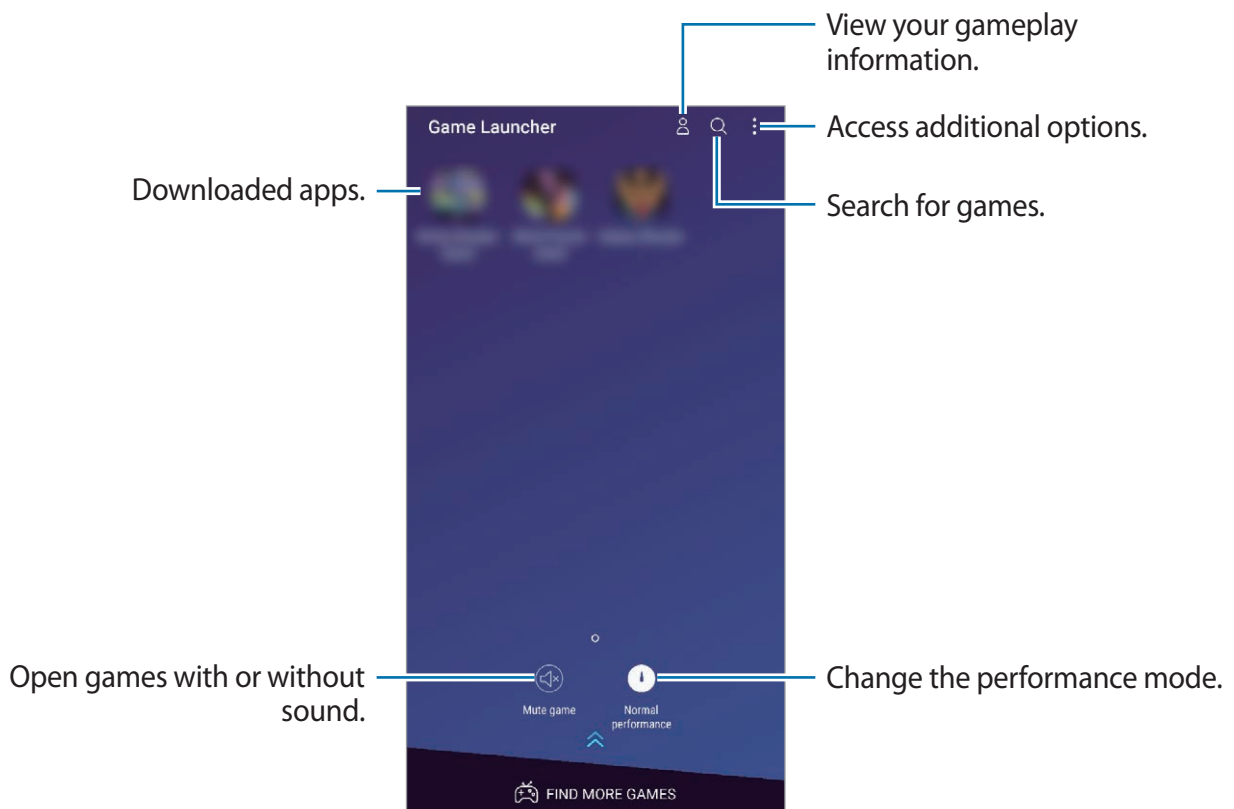

## Using Game Launcher

- 1 Launch the **Settings** app, tap **Advanced features** → **Games**, and then tap the **Game Launcher** switch to activate it.

**Game Launcher** will be added to the Home screen or the Apps screen.



When you deactivate the feature, **Game Launcher** will be removed from the Home screen and the Apps screen.

- 2 Launch the **Game Launcher** app.

- 3 Tap a game from the games list.

To find more games, drag the screen upwards.



Games downloaded from **Play Store** and **Galaxy Apps** will be automatically shown on the game launcher screen. If you cannot see your games, tap  → **Add a game**.

## Removing a game from Game Launcher

Tap and hold a game and tap **Remove**.

## Changing the performance mode

You can change the game performance mode.

Launch the **Game Launcher** app, tap **Normal performance**, and then tap the button repeatedly to select the mode you want.

- **Normal performance:** Power saving mode or high performance mode is not used.
- **Save power:** This decreases the battery power consumption but it will reduce the system performance.
- **High performance:** This improves system performance but it will increase the battery power consumption.



Battery power efficiency may vary by game.



## Using Game Tools

You can use various options on the Game Tools panel while playing a game. To open the Game Tools panel, tap  on the navigation bar. If the navigation bar is hidden, drag upwards from the bottom of the screen to show it.

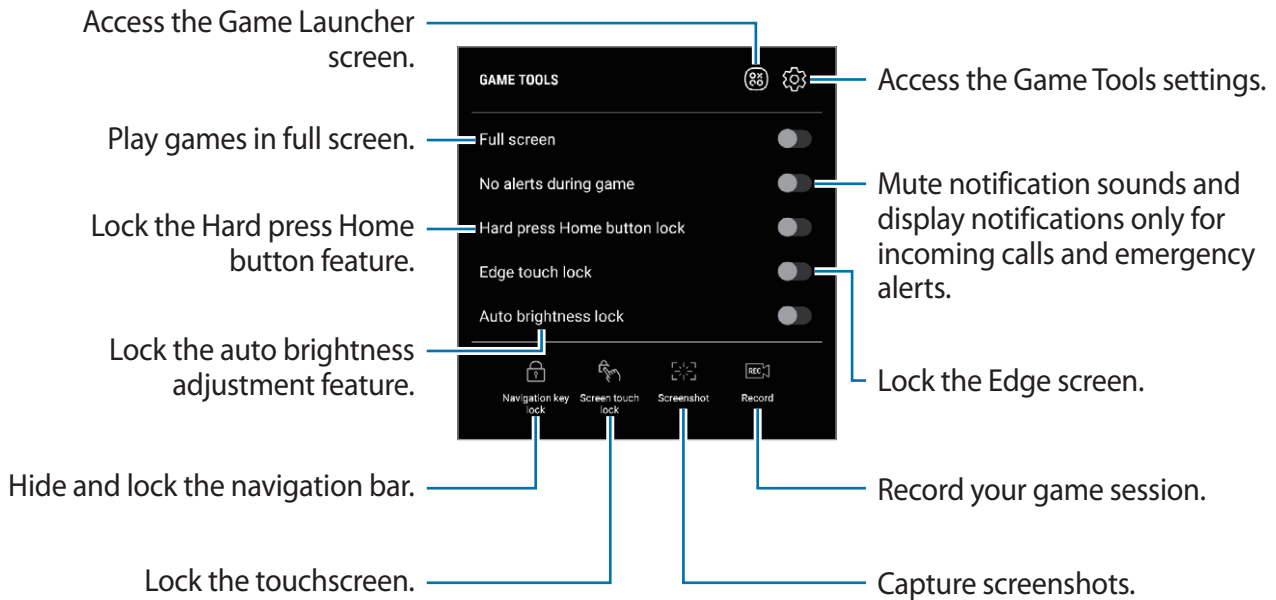

## Blocking notifications during games

Tap  and tap the **No alerts during game** switch to activate it. The device will mute notification sounds and display only notifications for incoming calls and emergency alerts, so that you can enjoy your games without being disturbed. If you receive an incoming call, a small notification will appear at the top of the screen.

# SmartThings

## Introduction

Connect to nearby devices, such as Bluetooth headsets or other smartphones, easily and quickly. You can also control and manage TVs, home appliances, and Internet of Things (IoT) products with your smartphone.

- **Connecting with nearby devices:** Connect with nearby devices, such as Bluetooth headsets or wearable devices, easily and quickly.
- **Registering and controlling home appliances, TVs, and IoT products:** Register smart refrigerators, washers, air conditioners, air purifiers, TVs, and Internet of Things (IoT) products on your smartphone, and view their status or control them from your smartphone's screen.
- **Receiving notification:** Receive notifications from connected devices on your smartphone. For example, when the laundry is finished, you can receive a notification on your smartphone.

Open the **Samsung** folder and launch the **SmartThings** app. The dashboard will appear.

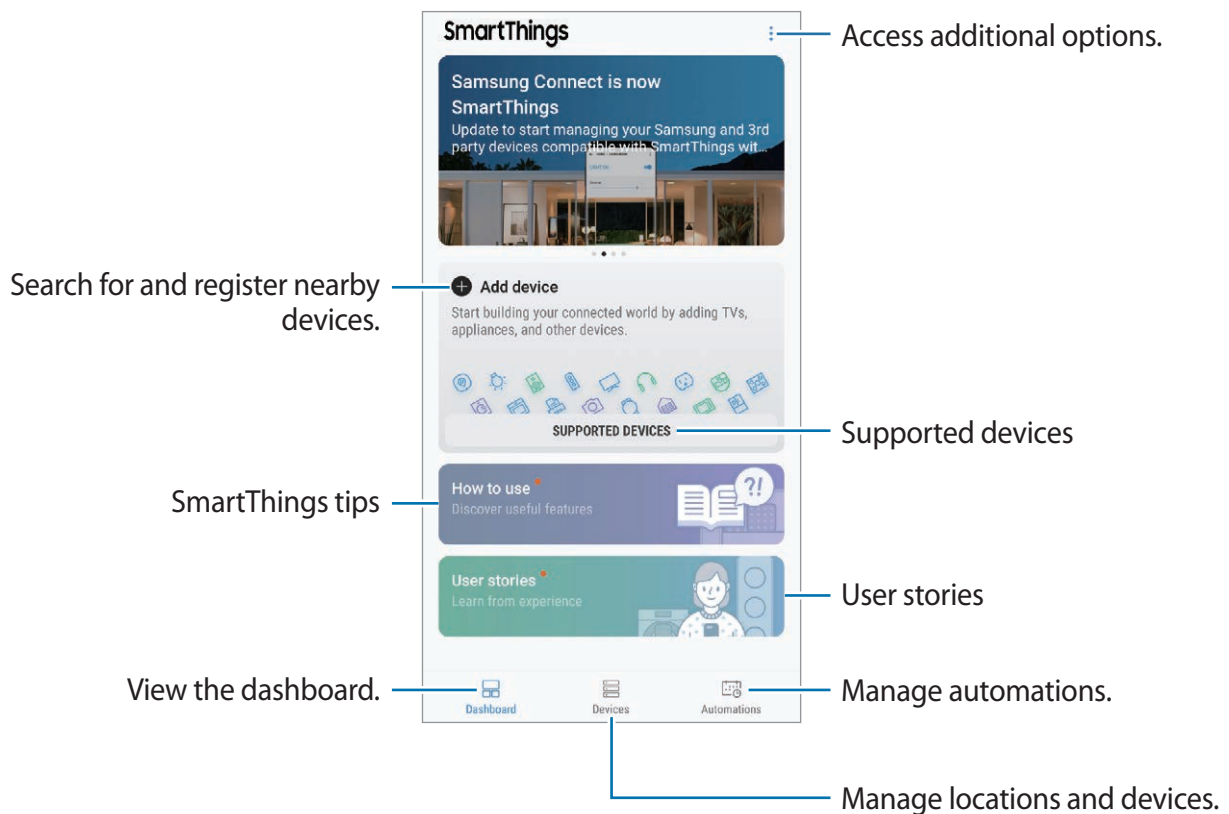



- To use SmartThings, your smartphone and other devices must be connected to a Wi-Fi or mobile network.
- To fully use SmartThings, you must register and sign in to your Samsung account.
- The devices you can connect may vary depending on the region or service provider. To see the list of connectable devices, open the **Samsung** folder, launch the **SmartThings** app, and then tap **SUPPORTED DEVICES**.
- Available features may differ depending on the connected device.
- Connected devices' own errors or defects are not covered by the Samsung warranty. When errors or defects occur on the connected devices, contact the device's manufacturer.

## Connecting to nearby devices

Connect to nearby devices, such as Bluetooth headsets, easily and quickly.



Connection methods may vary depending on the type of connected devices or the shared content.

- 1 Open the **Samsung** folder and launch the **SmartThings** app.
- 2 On the dashboard, tap **Add device**.
- 3 Select a device from the list and connect to it by following the on-screen instructions.

## Using home appliances, TVs, and IoT products

View the status of your smart appliances, TVs, and IoT products from your smartphone's screen. You can group devices by location and add rules to control the devices easily and conveniently.

### Connecting devices

- 1 Open the **Samsung** folder and launch the **SmartThings** app.
- 2 On the dashboard, tap **Add device**.
- 3 Select a device from the list.  
If there is no device on the list, tap  under **ADD DEVICE MANUALLY** and select a device type. Or, tap **Search** and enter the device or model name.
- 4 Follow the on-screen instructions to register devices.

### Viewing and controlling connected devices

You can view and control the devices. For example, you can check the ingredients in your refrigerator or adjust the TV volume.

- 1 Open the **Samsung** folder, launch the **SmartThings** app, and then tap **Devices**.  
The list of connected devices will appear.
- 2 View the status of devices on the list.  
To control the devices, select a device. When the device controller supplied with the selected device is downloaded, you can control the device.

### Adding devices and scenes by locations

Add devices by locations, view the list of devices in a same location, and control them. You can also add a scene to a location to control multiple devices at the same time.

## Adding locations

- 1 Open the **Samsung** folder, launch the **SmartThings** app, and then tap **Devices** → **ALL DEVICES** → **Add location**.
- 2 Enter the location name.  
To set a location, tap **Geolocation** to select a location on the map and tap **DONE**.
- 3 Tap **SAVE**.  
Your location will be added.  
To add devices to the location, tap **ADD DEVICE** and follow the on-screen instructions to register devices.  
The devices will be added to the location.

## Adding scenes

Add a scene and register devices to it to control multiple devices at the same time with a single tap of a button or with a voice command.

Open the **Samsung** folder, launch the **SmartThings** app, select a location, tap  → **Add scene**, and then set scene options. You can set the scene name, icon, and devices.

## Adding automations

You can also set an automation to perform actions automatically depending on the preset time or the status of devices.

For example, add an automation to turn on the audio automatically every day at 7:00 AM.

- 1 Open the **Samsung** folder, launch the **SmartThings** app, and then tap **Automations** → **ADD AUTOMATION**.
- 2 Tap **When do you want to use this automation?** to set the conditions and tap **DONE**.
- 3 Tap **What do you want this automation to do?** to set devices and actions to perform and tap **DONE**.  
To receive a notification when an automation runs, tap **Notify me** and enter the message.

## Receiving notifications

You can receive notifications from connected devices on your smartphone. For example, when the laundry is finished, you can receive a notification on your smartphone.

To set devices to receive notifications, open the **Samsung** folder, launch the **SmartThings** app, tap **☰** → **Notifications** → **☰** → **Notifications settings**, and then tap the switches next to the devices you want.

## Sharing content

Share content by using various sharing options. The following actions are an example of sharing images.



You may incur additional charges when sharing files via the mobile network.

- 1 Launch the **Gallery** app and select an image.
- 2 Tap **☰** and select a sharing method, such as message or email.

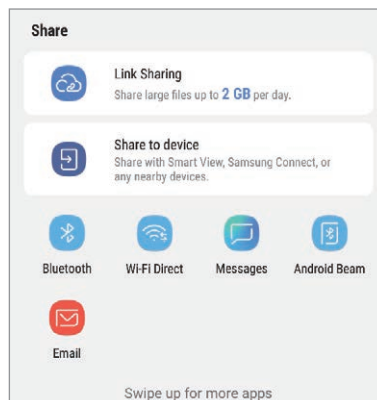

When you have a communication or sharing history, the people you contacted will appear on the sharing options panel. To directly share content with them via the corresponding app, select a person's icon. If the feature is not activated, launch the **Settings** app, tap **Advanced features**, and then tap the **Direct share** switch to activate it.

## Using additional features

- **Link Sharing:** Share large files. Upload files to the Samsung storage server and share them with others via a Web link or a code. To use this feature, your phone number must be verified.
- **Share to device:** Share content with nearby devices via Wi-Fi Direct or Bluetooth, or with SmartThings supported devices. You can also view your device's displayed content on a large screen by connecting your device to a Smart View-enabled TV or monitor.

When the image is sent to the recipients' devices, a notification will appear on their devices. Tap the notification to view or download the image.

# Samsung DeX

## Introduction

Samsung DeX is a service that allows you to use your smartphone like a computer by connecting the smartphone to an external display, such as a TV or monitor. You can use your smartphone's features on a large screen conveniently.



- For more information about using the DeX Pad, refer to the DeX Pad's user manual.
- All accessories, including the DeX Pad, are sold separately.



## DeX Pad device layout

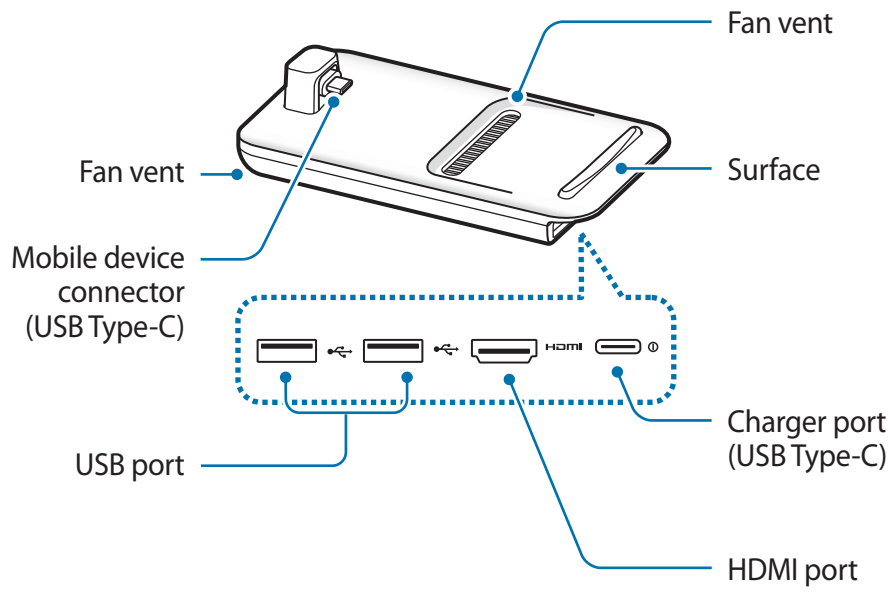



## Connecting devices

1 Connect the charger to the DeX Pad's charger port (USB Type-C).



Use only Samsung-approved chargers that support the fast charging feature.

2 Connect one end of the HDMI cable to the DeX Pad's HDMI port, and plug the other end of the cable into a TV or monitor's HDMI port.



Use only the HDMI cable supplied with the DeX Pad. Otherwise, the DeX Pad may not work properly.

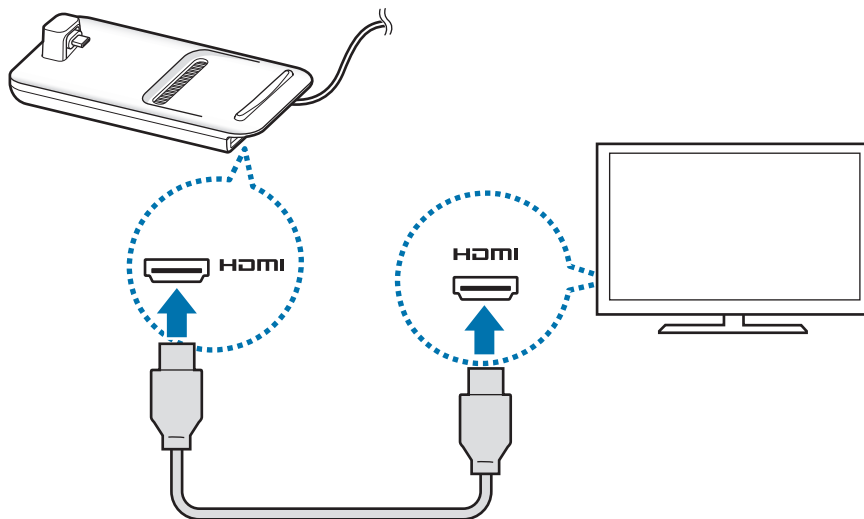

- 3 Connect your smartphone's multipurpose jack to the mobile device connector on the DeX Pad.

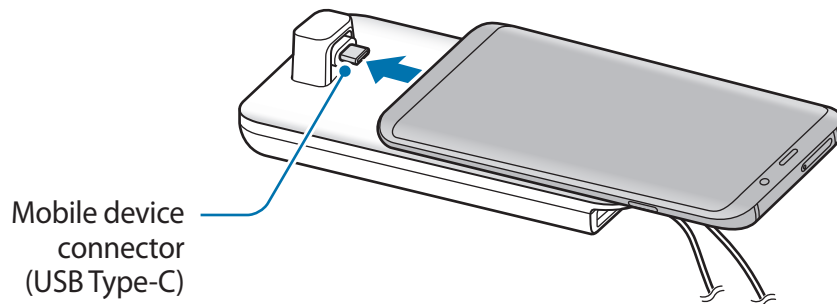

- Ensure that your smartphone is horizontal to the connector. Otherwise, the DeX Pad and your smartphone may be damaged.

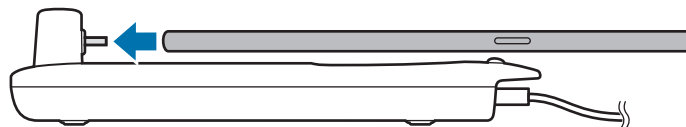

- If you connect your smartphone with a case attached, it may not correctly connect to the DeX Pad or run Samsung DeX properly depending on your device's case. Remove the case before use.

- 4 On your smartphone's screen, select the screen mode you want to use. You can choose from Samsung DeX mode or screen mirroring mode.

- **START SAMSUNG DeX:** Your smartphone's screen will change into a touchpad and appear on the connected TV or monitor in Samsung DeX mode.
- **SWITCH TO SCREEN MIRRORING:** The same screen as your smartphone will appear on the connected TV or monitor.

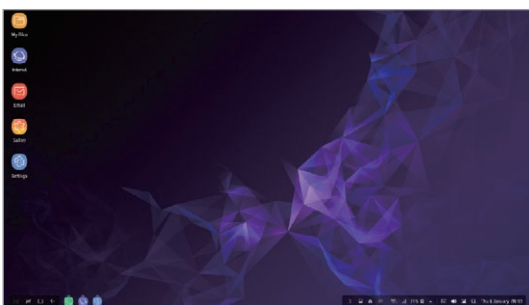

Samsung DeX mode

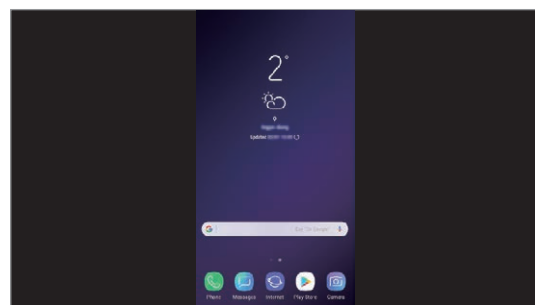

Screen mirroring mode



The screen mode you first select will be applied for subsequent connections. Refer to [Changing screen mode](#) for more information.

## Controlling the Samsung DeX screen

### Controlling via your smartphone

When you connect your smartphone to the DeX Pad, you can use your smartphone as a touchpad.



- The touchpad is available only in Samsung DeX mode.
- If your smartphone's case has a front cover, open the front cover to use your smartphone as a touchpad. If the front cover is closed, the touchpad may not work properly.



### Controlling the screen

- Tapping: Launch an app or select a button.
- Tapping with two fingers: Show the additional options.
- Swiping with two fingers: Scrolling the screen in any direction.
- Spreading or pinching with two fingers: Zoom in or out.
- Tapping and holding: Select an item on the screen.
- Dragging: Move an item or select text.

## Orienting your smartphone's screen

When you are using your smartphone as a touchpad, you can use it in either the horizontal or vertical alignment.

- 1 When the DeX Pad and your smartphone are connected, raise both of them to be perpendicular to the surface (1). Then, turn the smartphone to be either vertical or horizontal, the orientation you want (2).

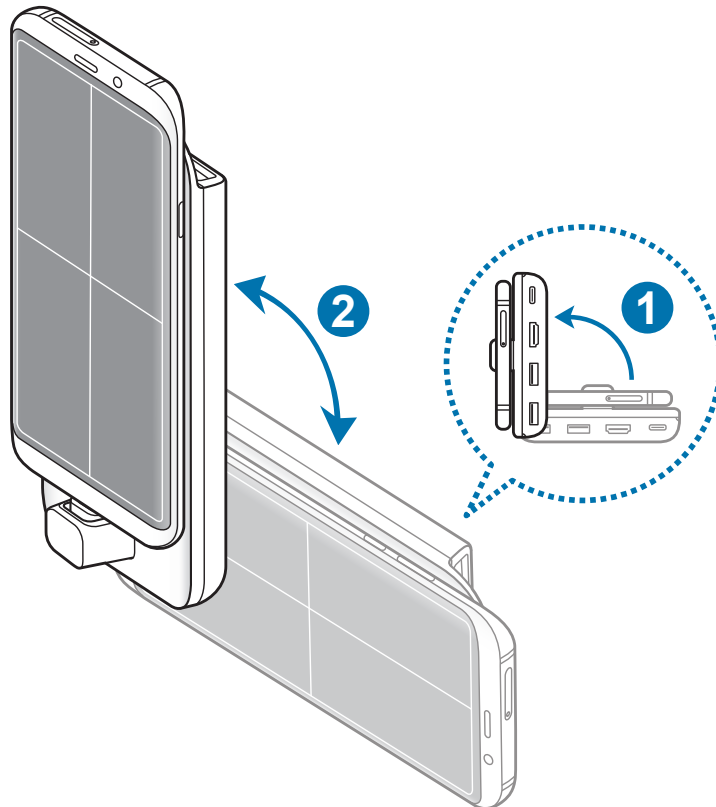

2 Move both the DeX Pad and your smartphone up and down slightly.

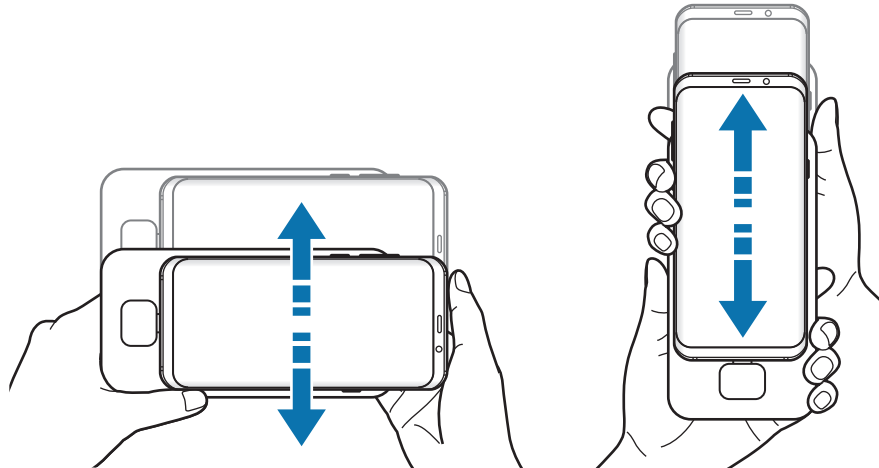

If the touchpad has been properly oriented, the  icon will appear at the top right of the touchpad.

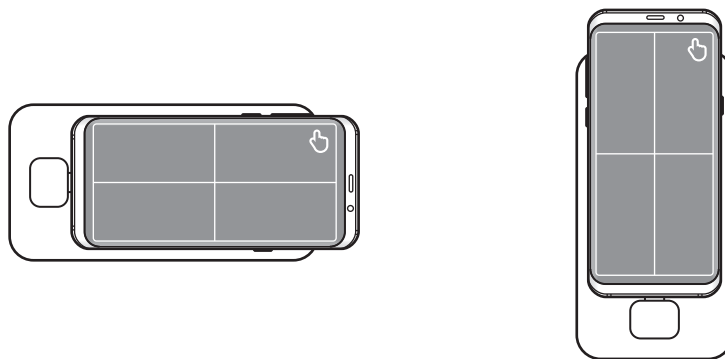

## Controlling via keyboard and mouse

To use a keyboard and mouse, connect them to the DeX Pad's USB ports.



- When you connect a keyboard, the screen keyboard will not appear when you select the text input field.
- When you connect a mouse, the touchpad will not appear on your smartphone.

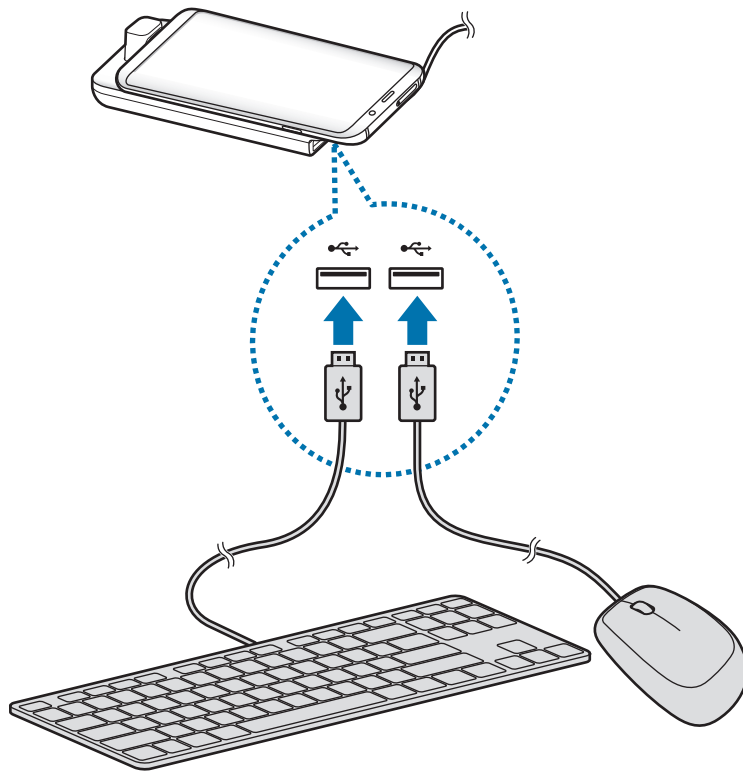

You can also use a wireless keyboard/mouse or Bluetooth keyboard/mouse. Refer to the respective device's manual for more information.

## Using Samsung DeX

Use your smartphone's features in an interface environment similar to a computer. You can multitask by running multiple apps simultaneously. You can also check your smartphone's notifications and status.

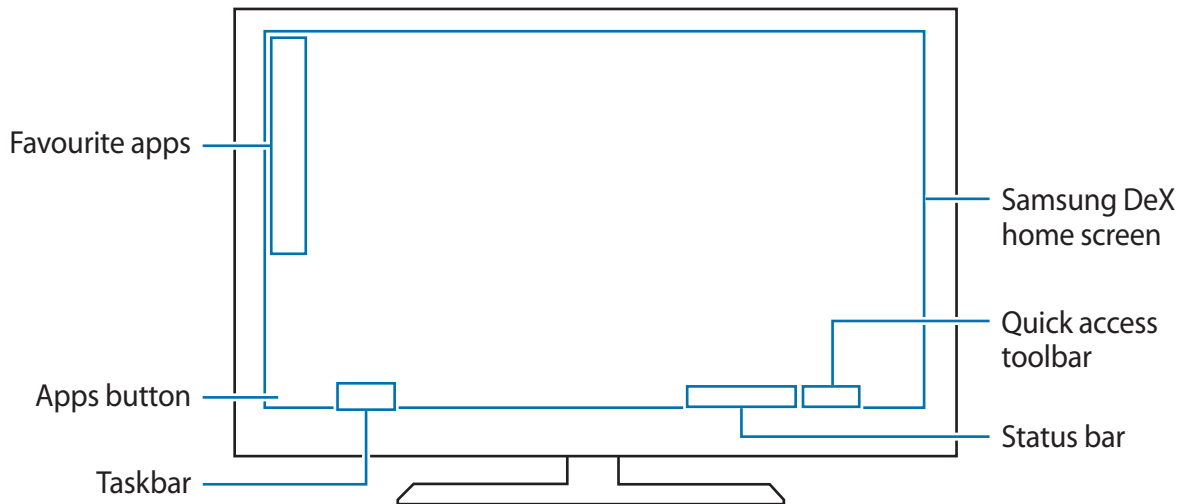

- When starting or ending Samsung DeX, running apps may be closed.
- Some apps or features may not be available when using Samsung DeX.
- To adjust the screen settings, use the connected TV or monitor's display settings.
- **Favourite apps:** Add frequently used apps to the Home screen and launch them quickly.
- **Apps button:** View and run your smartphone's apps. To install apps that are optimized for Samsung DeX, tap **Apps for Samsung DeX**.
- **Taskbar:** View the apps that are currently running.
- **Status bar:** View your smartphone's notifications and status. Status icons may appear differently depending on your smartphone's status. When you click ▲, the quick setting buttons will appear. You can activate or deactivate certain smartphone features using the quick setting buttons.
- **Quick access toolbar:** Use quick tools, such as screen keyboard, volume control, or search.

## Using the screen keyboard

Open the screen keyboard on the connected TV or monitor to enter text.

On the quick access toolbar, tap .

The screen keyboard will appear.

## Enjoying games vividly on a large screen

Play your smartphone's games on a large screen. On the connected TV or monitor, launch the **Game Launcher** app.

## Answering calls



While using Samsung DeX, you can answer calls from your smartphone on the connected TV or monitor. Select the call answering option on the connected TV or monitor to answer a call. Your smartphone's speaker will be used during the calls.



If you do not want to use the speakerphone, connect earphones or remove your smartphone from the DeX Pad. It may take a few seconds to display the call screen on the smartphone.

## Changing screen mode

You can change the screen mode on the connected TV or monitor.

1 On the status bar, tap  and tap  next to **Samsung DeX**.

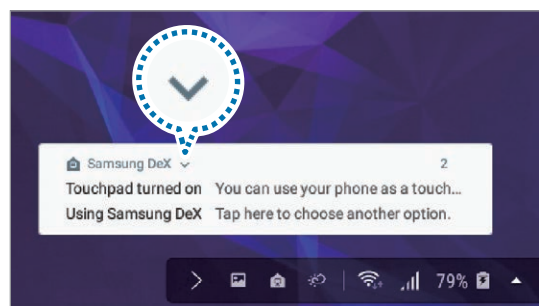
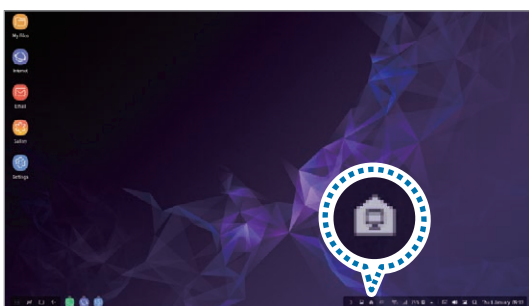



2 Tap  above **Using Samsung DeX** and select **SCREEN MIRRORING** or **FAST CHARGING**.

- **SCREEN MIRRORING:** The same screen as your smartphone will appear on the connected TV or monitor.
- **FAST CHARGING:** The connected TV or monitor will be off and your smartphone will start fast charging.

If you want to switch modes on your smartphone, open the notification panel, tap  next to **Samsung DeX**, and then select the mode you want.

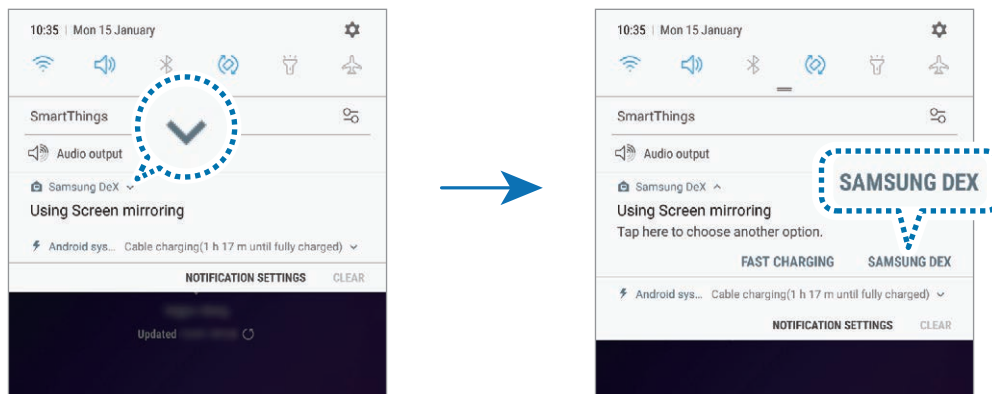

## Ending the connection

To disconnect your smartphone from the connected monitor, remove your smartphone from the DeX Pad.



Do not pull or shake your smartphone excessively when disconnecting it from the multimedia dock. Doing so may damage the mobile device connector.

## Connecting to an external display

You can connect your smartphone to an external display, such as a TV or monitor, and view presentations or movies on the connected display. Connect your smartphone to an external display using an HDMI cable and HDMI adapter (USB Type-C to HDMI). You can view your smartphone's content on the connected screen.



- HDMI cables and adapters (USB Type-C to HDMI) are sold separately.
- Use only a Samsung-approved HDMI adapter (USB Type-C to HDMI). Performance problems and malfunctions caused by using unapproved accessories are not covered by the warranty.

- 1 Connect an HDMI adapter (USB Type-C to HDMI) to your smartphone.
- 2 Connect an HDMI cable to the HDMI adapter (USB Type-C to HDMI) and to a TV or monitor's HDMI port.

Your smartphone's screen will appear on the connected screen.

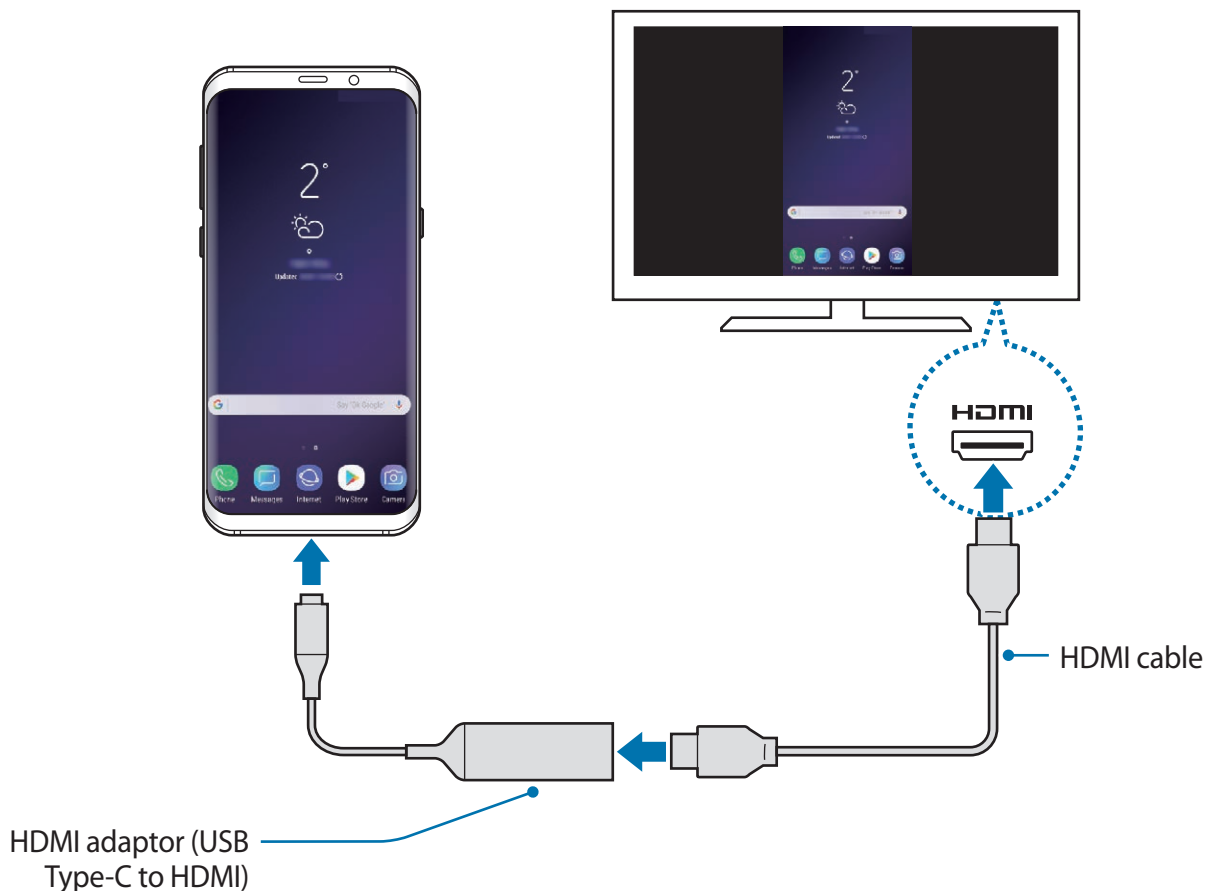

## Google apps

Google provides entertainment, social network, and business apps. You may require a Google account to access some apps.

To view more app information, access each app's help menu.



Some apps may not be available or may be labeled differently depending on the region or service provider.

### Chrome

Search for information and browse webpages.

### Gmail

Send or receive emails via the Google Mail service.

### Maps

Find your location on the map, search the world map, and view location information for various places around you.

### Play Music

Discover, listen to, and share music on your device. You can upload music collections stored on your device to the cloud and access them later.

### Play Movies & TV

Purchase or rent videos, such as movies and TV programs, from **Play Store**.

### Drive

Store your content on the cloud, access it from anywhere, and share it with others.

## **YouTube**

Watch or create videos and share them with others.

## **Photos**

Search for, manage, and edit all your photos and videos from various sources in one place.

## **Google**

Search quickly for items on the Internet or your device.

## **Duo**

Make a simple video call.



# Settings

## Introduction

Customize device settings. You can make your device more personalized by configuring various setting options.

Launch the **Settings** app.

To search for settings by entering keywords, tap **Search** or .

## Connections

### Options

Change settings for various connections, such as the Wi-Fi feature and Bluetooth.

On the Settings screen, tap **Connections**.

- **Wi-Fi:** Activate the Wi-Fi feature to connect to a Wi-Fi network and access the Internet or other network devices. Refer to [Wi-Fi](#) for more information.
- **Bluetooth:** Use Bluetooth to exchange data or media files with other Bluetooth-enabled devices. Refer to [Bluetooth](#) for more information.
- **Phone visibility:** Allow other devices to find your device to share content with you. When this feature is activated, your device will be visible to other devices when they search for available devices using their Transfer files to device option.
- **Data usage:** Keep track of your data usage amount and customize the settings for the limitation. Set the device to automatically disable the mobile data connection when the amount of mobile data you have used reaches your specified limit.

You can also activate the data saver feature to prevent some apps running in the background from sending or receiving data. Refer to [Data saver](#) for more information.

- **Flight mode:** Set the device to disable all wireless functions on your device. You can use only non-network services.



Make sure the device is turned off during takeoff and landing. After takeoff, you can use the device in flight mode if allowed by aircraft personnel.

- **NFC and payment:** Set the device to allow you to read near field communication (NFC) tags that contain information about products. You can also use this feature to make payments and buy tickets for transportation or events after downloading the required apps. Refer to [NFC and payment](#) for more information.
- **Mobile Hotspot and Tethering:** Use the device as a mobile hotspot to share the device's mobile data connection with other devices when the network connection is not available. Connections can be made via Wi-Fi, USB, or Bluetooth. Refer to [Mobile Hotspot and Tethering](#) for more information.
- **Mobile networks:** Configure your mobile network settings.
- **Location:** Change settings for location information permissions.
- **More connection settings:** Customize settings to control other features. Refer to [More connection settings](#) for more information.

## Wi-Fi

Activate the Wi-Fi feature to connect to a Wi-Fi network and access the Internet or other network devices.



Turn off Wi-Fi to save the battery when not in use.

## Connecting to a Wi-Fi network

1 On the Settings screen, tap **Connections** → **Wi-Fi**, and then tap the switch to activate it.

2 Select a network from the Wi-Fi networks list.

Networks that require a password appear with a lock icon. Enter the password and tap **CONNECT**.



- Once the device connects to a Wi-Fi network, the device will reconnect to that network each time it is available without requiring a password. To prevent the device connecting to the network automatically, tap the network name and tap **Auto reconnect** to remove the the checkmark.
- If you do not want to connect to the network again, tap the network name and tap **FORGET**.
- If you cannot connect to a Wi-Fi network properly, restart your device's Wi-Fi feature or the wireless router.

## Wi-Fi Direct

Wi-Fi Direct connects devices directly via a Wi-Fi network without requiring an access point.

1 On the Settings screen, tap **Connections** → **Wi-Fi**, and then tap the switch to activate it.

2 Tap **Wi-Fi Direct**.

The detected devices are listed.

If the device you want to connect to is not in the list, request that the device turns on its Wi-Fi Direct feature.

3 Select a device to connect to.

The devices will be connected when the other device accepts the Wi-Fi Direct connection request.



## Sending and receiving data

You can share data, such as contacts or media files, with other devices. The following actions are an example of sending an image to another device.

- 1 Launch the **Gallery** app and select an image.
- 2 Tap  → **Wi-Fi Direct** and select a device to transfer the image to.
- 3 Accept the Wi-Fi Direct connection request on the other device.  
If the devices are already connected, the image will be sent to the other device without the connection request procedure.

## Ending the device connection

- 1 On the Settings screen, tap **Connections** → **Wi-Fi**.
- 2 Tap **Wi-Fi Direct**.  
The device displays the connected devices in the list.
- 3 Tap the device name to disconnect the devices.

## Bluetooth

Use Bluetooth to exchange data or media files with other Bluetooth-enabled devices.



- Samsung is not responsible for the loss, interception, or misuse of data sent or received via Bluetooth.
- Always ensure that you share and receive data with devices that are trusted and properly secured. If there are obstacles between the devices, the operating distance may be reduced.
- Some devices, especially those that are not tested or approved by the Bluetooth SIG, may be incompatible with your device.
- Do not use the Bluetooth feature for illegal purposes (for example, pirating copies of files or illegally tapping communications for commercial purposes).  
Samsung is not responsible for the repercussion of illegal use of the Bluetooth feature.

### Pairing with other Bluetooth devices

- 1 On the Settings screen, tap **Connections** → **Bluetooth**, and then tap the switch to activate it.

The detected devices will be listed.

- 2 Select a device to pair with.

If the device you want to pair with is not on the list, set the device to enter Bluetooth pairing mode. Refer to the other device's user manuals.



Your device is visible to other devices while the Bluetooth settings screen is open.

- 3 Accept the Bluetooth connection request on your device to confirm.

The devices will be connected when the other device accepts the Bluetooth connection request.

## Sending and receiving data

Many apps support data transfer via Bluetooth. You can share data, such as contacts or media files, with other Bluetooth devices. The following actions are an example of sending an image to another device.

- 1 Launch the **Gallery** app and select an image.
- 2 Tap  → **Bluetooth**, and then select a device to receive the image.  
If your device has paired with the device before, tap the device name without confirming the auto-generated passkey.  
If the device you want to pair with is not in the list, turn on its visibility option.
- 3 Accept the Bluetooth connection request on the other device.

## Dual audio

You can connect up to two Bluetooth audio devices to your smartphone. Connect two Bluetooth headsets or speakers to use them at the same time.



To use this feature, the Bluetooth audio devices you want to connect must support the **Media audio** feature.

- 1 On the Settings screen, tap **Connections** → **Bluetooth**, and then tap the switch to activate it.  
The detected devices will be listed.
- 2 Tap  → **Dual audio**, tap the switch to activate it, and then tap the Back button.
- 3 Select a device to pair with.  
If the device you want to pair with is not in the list, turn on its visibility option or enter Bluetooth pairing mode on the device. Refer to the device's user manuals for more information.

- 4 Tap  next to the connected device and tap the **Media audio** switch to activate it.
- 5 Select another device from the list and activate its **Media audio** feature.

## Unpairing Bluetooth devices

- 1 On the Settings screen, tap **Connections** → **Bluetooth**.  
The device displays the paired devices in the list.
- 2 Tap  next to the device name to unpair.
- 3 Tap **Unpair**.

## Data saver

Reduce your data usage by preventing some apps running in the background from sending or receiving data.

On the Settings screen, tap **Connections** → **Data usage** → **Data saver** and tap the switch to activate it.

When the data saver feature is activated, the  icon will appear on the status bar.

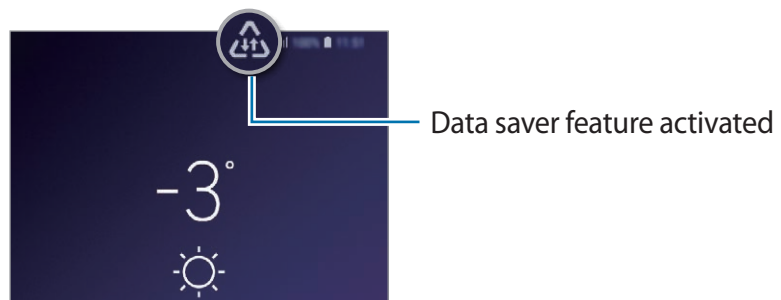

-  To select apps to use data without restriction, tap **Allow app while Data saver on** and select apps.

## NFC and payment

Your device allows you to read near field communication (NFC) tags that contain information about products. You can also use this feature to make payments and buy tickets for transportation or events after downloading the required apps.



The device contains a built-in NFC antenna. Handle the device carefully to avoid damaging the NFC antenna.

### Reading information from NFC tags

Use the NFC feature to send images or contacts to other devices, and read product information from NFC tags.

- 1 On the Settings screen, tap **Connections** and tap the **NFC and payment** switch to activate it.
- 2 Place the NFC antenna area on the back of your device near an NFC tag.  
The information from the tag appears.

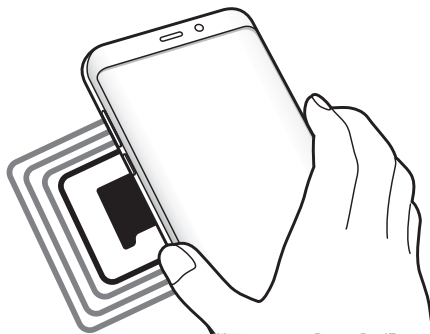

Ensure that the device's screen is turned on and unlocked. Otherwise, the device will not read NFC tags or receive data.

## Making payments with the NFC feature

Before you can use the NFC feature to make payments, you must register for the mobile payment service. To register or get more information about the service, contact your service provider.

- 1 On the Settings screen, tap **Connections** and tap the **NFC and payment** switch to activate it.
- 2 Touch the NFC antenna area on the back of your device to the NFC card reader.

To set the default payment app, open the Settings screen and tap **Connections** → **NFC and payment** → **Tap and pay** → **PAYMENT**, and then select an app.



The payment services list may not include all available payment apps.

## Sending data with the NFC feature

Allow data exchange when your device's NFC antenna touches the other device's NFC antenna.

- 1 On the Settings screen, tap **Connections** → **NFC and payment** and tap the switch to activate it.
- 2 Tap the **Android Beam** switch to activate it.
- 3 Select an item and touch the other device's NFC antenna to your device's NFC antenna.

4 When **Touch to beam.** appears on the screen, tap your device's screen to send the item.



If both devices try to send data simultaneously, the file transfer may fail.

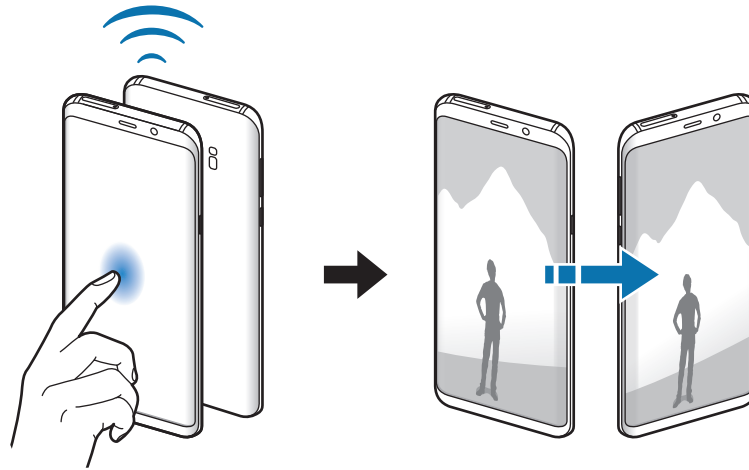

## Mobile Hotspot and Tethering

Use the device as a mobile hotspot to share the device's mobile data connection with other devices when the network connection is not available. Connections can be made via Wi-Fi, USB, or Bluetooth.

On the Settings screen, tap **Connections** → **Mobile Hotspot and Tethering**.





You may incur additional charges when using this feature.

- **Mobile Hotspot:** Use the mobile hotspot to share the device's mobile data connection with computers or other devices.
- **USB tethering:** Use USB tethering to share the device's mobile data connection with a computer via USB. When connected to a computer, the device is used as a wireless modem for the computer.

## Using the mobile hotspot

Use your device as a mobile hotspot to share your device's mobile data connection with other devices.

- 1 On the Settings screen, tap **Connections** → **Mobile Hotspot and Tethering** → **Mobile Hotspot**.
- 2 Tap the switch to activate it.  
The  icon appears on the status bar. Other devices can find your device in the Wi-Fi networks list.  
To set a password for the mobile hotspot, tap  → **Configure Mobile Hotspot** and select the level of security. Then, enter a password and tap **SAVE**.
- 3 On the other device's screen, search for and select your device from the Wi-Fi networks list.
- 4 On the connected device, use the device's mobile data connection to access the Internet.



## More connection settings

Customize settings to control other features.

On the Settings screen, tap **Connections** → **More connection settings**.

- **Nearby device scanning:** Set the device to scan for nearby devices to connect to.
- **Printing:** Configure settings for printer plug-ins installed on the device. You can search for available printers or add one manually to print files. Refer to [Printing](#) for more information.
- **MirrorLink:** Use the MirrorLink feature to control your device's MirrorLink apps on the vehicle's head unit monitor. Refer to [MirrorLink](#) for more information.
- **Download booster:** Set the device to download files larger than 30 MB faster using Wi-Fi and mobile networks simultaneously. Refer to [Download booster](#) for more information.
- **VPN:** Set up virtual networks (VPNs) on your device to create safe, encrypted connections over less secure networks, such as the internet.
- **Ethernet:** When you connect an Ethernet adapter, you can use a wired network and configure network settings.

## Printing

Configure settings for printer plug-ins installed on the device. You can connect the device to a printer via Wi-Fi or Wi-Fi Direct, and print images or documents.



Some printers may not be compatible with the device.

## Adding printer plug-ins

Add printer plug-ins for printers you want to connect the device to.

- 1 On the Settings screen, tap **Connections** → **More connection settings** → **Printing** → **Add service**.
- 2 Search for a printer plug-in in **Play Store**.
- 3 Select a printer plug-in and install it.

- 4 Select the printer plug-in and tap the switch to activate it.

The device searches for printers that are connected to the same Wi-Fi network as your device.

- 5 Select a printer to add.



To add printers manually, tap  → **Add printer**.

## Printing content

While viewing content, such as images or documents, access the options list, tap **Print** → ▼ → **All printers...**, and then select a printer.



Printing methods may vary depending on the content type.

## MirrorLink

You can display your device's screen on the vehicle's head unit monitor.

Connect your device to a vehicle to control your device's MirrorLink apps on the vehicle's head unit monitor.

On the Settings screen, tap **Connections** → **More connection settings** → **MirrorLink**.



Your device is compatible with vehicles that support MirrorLink version 1.1 or higher.

## Connecting your device to a vehicle via MirrorLink

When using this feature for the first time, connect the device to a Wi-Fi or mobile network.

- 1 Pair your device with a vehicle via Bluetooth.

Refer to [Pairing with other Bluetooth devices](#) for more information.

- 2 Connect your device to the vehicle using a USB cable.

When they are connected, access your device's MirrorLink apps on the head unit monitor.

## Ending the MirrorLink connection

Unplug the USB cable from your device and the vehicle.

## Download booster

Set the device to download files larger than 30 MB faster using Wi-Fi and mobile networks simultaneously. A stronger Wi-Fi signal will provide a faster download speed.

On the Settings screen, tap **Connections** → **More connection settings** → **Download booster**.



- This feature may not be supported by some devices.
- You may incur additional charges when downloading files via the mobile network.
- When you download large files, the device may heat up. If the device exceeds a set temperature, the feature will turn off.
- If network signals are unstable, the speed and performance of this feature may be affected.
- If the Wi-Fi and mobile network connections have significantly different data transfer speeds, the device may use only the fastest connection.
- This feature supports Hypertext Transmission Protocol (HTTP) 1.1 and Hypertext Transmission Protocol Secure (HTTPS). The feature cannot be used with other protocols, such as FTP.

# Sounds and vibration

## Options

Change settings for various sounds on the device.

On the Settings screen, tap **Sounds and vibration**.

- **Sound mode:** Set the device to use sound mode, vibration mode, or silent mode.
- **Vibrate while ringing:** Set the device to vibrate and play a ringtone for incoming calls.
- **Use Volume keys for media:** Set the device to adjust the media volume level when you press the Volume key.
- **Volume:** Adjust the volume level for call ringtones, music and videos, system sounds, and notifications.
- **Vibration intensity:** Adjust the force of the vibration notification.
- **Ringtone:** Change the call ringtone.
- **Vibration pattern:** Select a vibration pattern.
- **Notification sounds:** Change the notification sound.
- **Do not disturb:** Set the device to mute incoming calls, notification sounds, and media, except for allowed exceptions.
- **Touch sounds:** Set the device to sound when you select an app or option on the touchscreen.
- **Screen lock sounds:** Set the device to sound when you lock or unlock the touchscreen.
- **Charging sound:** Set the device to sound when it is connected to a charger.
- **Vibration feedback:** Set the device to vibrate when you tap the buttons on the navigation bar and for other actions, such as tapping and holding items.
- **Dialing keypad tones:** Set the device to sound when you tap the buttons on the keypad.
- **Keyboard sound:** Set the device to sound when a key is touched.

- **Keyboard vibration:** Set the device to vibrate when a key is touched.
- **Sound quality and effects:** Configure additional sound settings.  
You can also activate the surround sound mode. Refer to [Dolby Atmos \(surround sound\)](#) for more information.
- **Separate app sound:** Set the device to play media sound from a specific app on the connected Bluetooth speaker or headset separate from the sound of other apps. For example, you can listen to the Navigation app through your device's speaker while listening to playback from the Music app through the vehicle's Bluetooth speaker.

## Dolby Atmos (surround sound)

Select a surround sound mode optimized for various types of audio, such as movies, music, and voice. With Dolby Atmos, you can experience moving audio sounds that flows all around you.

On the Settings screen, tap **Sounds and vibration** → **Sound quality and effects** → **Dolby Atmos**, tap the switch to activate it, and then select a mode.

## Notifications

Change the notification settings for each app.

On the Settings screen, tap **Notifications**.

To display icon badges, tap the **App icon badges** switch to activate it. To change the badge style, tap **App icon badges**.

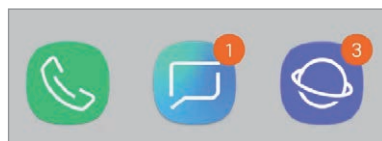

With number

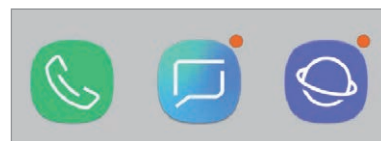

Without number

To customize notification settings for more apps, tap **ADVANCED** and select an app.

# Display

## Options

Change the display and the Home screen settings.

On the Settings screen, tap **Display**.

- **Brightness:** Adjust the brightness of the display.
- **Auto brightness:** Set the device to keep track of your brightness adjustments and apply them automatically in similar lighting conditions.
- **Blue light filter:** Activate the blue light filter and change the filter settings. Refer to [Blue light filter](#) for more information.
- **Font and screen zoom:** Change the screen zoom setting or font size and style.
- **Screen mode:** Change the screen mode to adjust the display's colour and contrast. Refer to [Changing the screen mode or adjusting the display colour](#) for more information.
- **Screen resolution:** Change the screen resolution. Refer to [Screen resolution](#) for more information.
- **Home screen:** Change the size of the grid to display more or fewer items on the Home screen and more.
- **Full screen apps:** Select apps to use with the full screen aspect ratio.
- **Easy mode:** Switch to easy mode to display larger icons and apply a simpler layout to the Home screen.
- **Icon frames:** Set whether to display shaded backgrounds to make icons stand out.
- **Edge screen:** Change the settings for the Edge screen. Refer to [Edge screen](#) for more information.
- **LED indicator:** Set the device to turn on the LED indicator when you charge the battery, when you have notifications, or when you make voice recordings while the screen is turned off.
- **Status bar:** Customize the settings for displaying notifications or indicators on the status bar.

- **Navigation bar:** Change the navigation bar settings. See [Navigation bar \(soft buttons\)](#) for more information.
- **Screen timeout:** Set the length of time the device waits before turning off the display's backlight.
- **Block accidental touches:** Set the device to prevent the screen from detecting touch input when it is in a dark place, such as a pocket or bag.
- **Screensaver:** Set the device to launch a screensaver when the device is charging. Refer to [Screensaver](#) for more information.

## Blue light filter

Reduce eye strain by limiting the amount of blue light emitted by the screen.



While you are watching HDR videos from HDR-exclusive video services, the blue light filter may not be applied.

- 1 On the Settings screen, tap **Display** → **Blue light filter**, and then tap the **Turn on now** switch to activate it.
- 2 Drag the adjustment bar to adjust the filter's opacity.
- 3 To set the schedule to apply the blue light filter, tap the **Turn on as scheduled** switch to activate it and select an option.
  - **Sunset to sunrise:** Set the device to apply the blue light filter at night and turn it off in the morning, based on your current location.
  - **Custom schedule:** Set a specific time to apply the blue light filter.

## Changing the screen mode or adjusting the display colour

Select a screen mode suitable for viewing movies or images, or adjust the display colour to your preference. If you select the **Adaptive display** mode, you can adjust the display colour balance by colour value.

### Changing the screen mode

On the Settings screen, tap **Display** → **Screen mode** and select a mode you want.

- **Adaptive display:** This optimizes the colour range, saturation, and sharpness of your display. You can also adjust the display colour balance by colour value.
- **AMOLED cinema:** This is suitable for watching videos.
- **AMOLED photo:** This is suitable for viewing images.
- **Basic:** This is set as default and is suitable for general use.



- You can adjust the display colour only in **Adaptive display** mode.
- **Adaptive display** mode may not be compatible with third-party apps.
- You cannot change the screen mode while applying the blue light filter.

### Optimizing the full screen colour balance

Optimize the display colour by adjusting the colour tones to your preference.

When you drag the colour adjustment bar towards **Cool**, the blue colour tone will increase. When you drag the bar towards **Warm**, the red colour tone will increase.

- 1 On the Settings screen, tap **Display** → **Screen mode** → **Adaptive display**.
- 2 Adjust the colour adjustment bar under **Full screen colour balance**.  
The colour balance of the screen will be optimized.





## Adjusting the screen tone by colour value

Increase or lower certain colour tones by adjusting the **Red**, **Green**, or **Blue** value individually.

- 1 On the Settings screen, tap **Display** → **Screen mode** → **Adaptive display**.
- 2 Tick **Advanced options**.
- 3 Adjust the **Red**, **Green**, or **Blue** colour bar to your preference.  
The screen tone screen will be adjusted.

## Screen resolution

Change the screen resolution. It is set to FHD+ by default. Higher resolutions make the display more vivid, however they will consume more battery power.

- 1 On the Settings screen, tap **Display** → **Screen resolution**.
- 2 Drag the adjustment bar to adjust the screen resolution, and then tap **APPLY**.  
Some currently running apps may close when you change the resolution.

## Screensaver

You can set to display images as a screensaver when the screen turns off automatically. The screensaver will be displayed when the device is charging.

- 1 On the Settings screen, tap **Display** → **Screensaver** and tap the switch to activate it.
- 2 Select an option.  
If you select **Photo Frame**, a slideshow with selected images will start. If you select **Photo Table**, selected images will appear as small cards and overlap.
- 3 Tap  to select albums for displaying images.
- 4 When you are finished, tap the Back button.  
To preview the selected option, tap **PREVIEW**.



When you tap the screen while your screensaver is displayed, the screen will turn on.

## Wallpapers and themes

Change the wallpaper settings for the Home screen and the locked screen or apply various themes to the device.

On the Settings screen, tap **Wallpapers and themes**.

- **Wallpapers:** Change the wallpaper settings for the Home screen and the locked screen.
- **Themes:** Change the device's theme.
- **Icons:** Change the icon style.
- **AOD:** Select an image to display on the Always On Display.

## Advanced features

### Options

Activate advanced features and change the settings that control them.

On the Settings screen, tap **Advanced features**.



Excessive shaking or an impact to the device may cause an unintended input for some features using sensors.

- **Smart stay:** Set the device to prevent the display from turning off while you are looking at it.
- **Games:** Activate the Game Launcher. Refer to [Game Launcher](#) for more information.
- **One-handed mode:** Activate one-handed operation mode for your convenience when using the device with one hand.



This feature may not be available depending on the region or service provider.

- **Finger sensor gestures:** Set the device to open or close the notification panel when you swipe upwards or downwards on the fingerprint recognition sensor. This feature is not available when the sensor is detecting your fingerprint.
- **Quick launch Camera:** Set the device to launch the camera by pressing the Power key twice quickly.



This feature may not be available depending on the region or service provider.

- **Device assistance app:** Select a device assistance app to launch when you press and hold the Home button. The device assistance app will gather information from the current screen and provide related information, apps, and features.
- **Multi window:** Select a Multi window launch method.
- **Smart capture:** Set the device to capture the current screen and scrollable area, and crop and share the screenshot immediately.
- **Palm swipe to capture:** Set the device to capture a screenshot when you swipe your hand to the left or right across the screen. You can view the captured images in **Gallery**.



It is not possible to capture a screenshot while using some apps and features.

- **Direct call:** Set the device to make a voice call by picking up and holding the device near your ear while viewing message or contact details.
- **Smart alert:** Set the device to alert you if you have missed calls or new messages when you pick up the device.



This feature may not work if the screen is turned on or the device is not on a flat surface.

- **Easy mute:** Set the device to mute incoming calls or alarms by using palm motions or facing the device's screen downwards.
- **Swipe to call or send messages:** Set the device to make a call or send a message when you swipe to the right or left on a contact or a phone number in the **Phone** or **Contacts** app.
- **Dual Messenger:** Install the second app and use two separate accounts for the same messenger app. Refer to [Dual Messenger](#) for more information.

- **Send SOS messages:** Set the device to send help messages by pressing the Power key three times. You can also send sound recordings along with the message to the recipients.
- **Direct share:** Set the device to display the people you contacted on the sharing options panel to allow you to share content directly.
- **Video enhancer:** Enhance the image quality of your videos to enjoy brighter and more vivid colours.



This feature may not be available in some apps.

- **Touch sensitivity:** Increase the touch sensitivity of the screen for use with screen protectors.



## Dual Messenger

Install the second app and use two separate accounts for the same messenger app.

- 1 On the Settings screen, tap **Advanced features** → **Dual Messenger**.

Supported apps will appear.

- 2 Tap the switch of an app to install the second app.

The second app will be installed. The second app's icon will be displayed with . When you receive notifications from the second app, the notifications will be displayed with  to distinguish them from the first app's notifications.

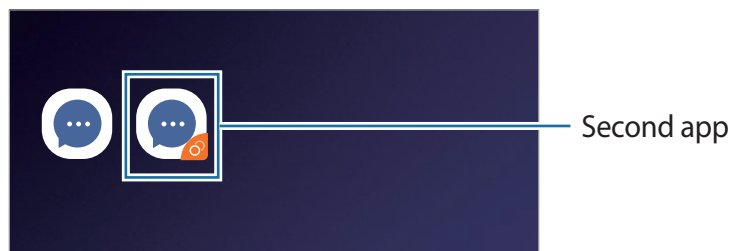

- The Dual Messenger feature may not be available depending on the app.
- Some features of the app may be limited for the second app.

## Uninstalling a second app

- 1 On the Settings screen, tap **Advanced features** → **Dual Messenger**.
- 2 Tap the switch of the app you want to disable and tap **DISABLE** or **UNINSTALL**.  
All data related to the second app will be deleted.



If you uninstall the first app, the second app will also be deleted.

## Device maintenance

The device maintenance feature provides an overview of the status of your device's battery, storage, memory, and system security. You can also automatically optimize the device with a tap of your finger.

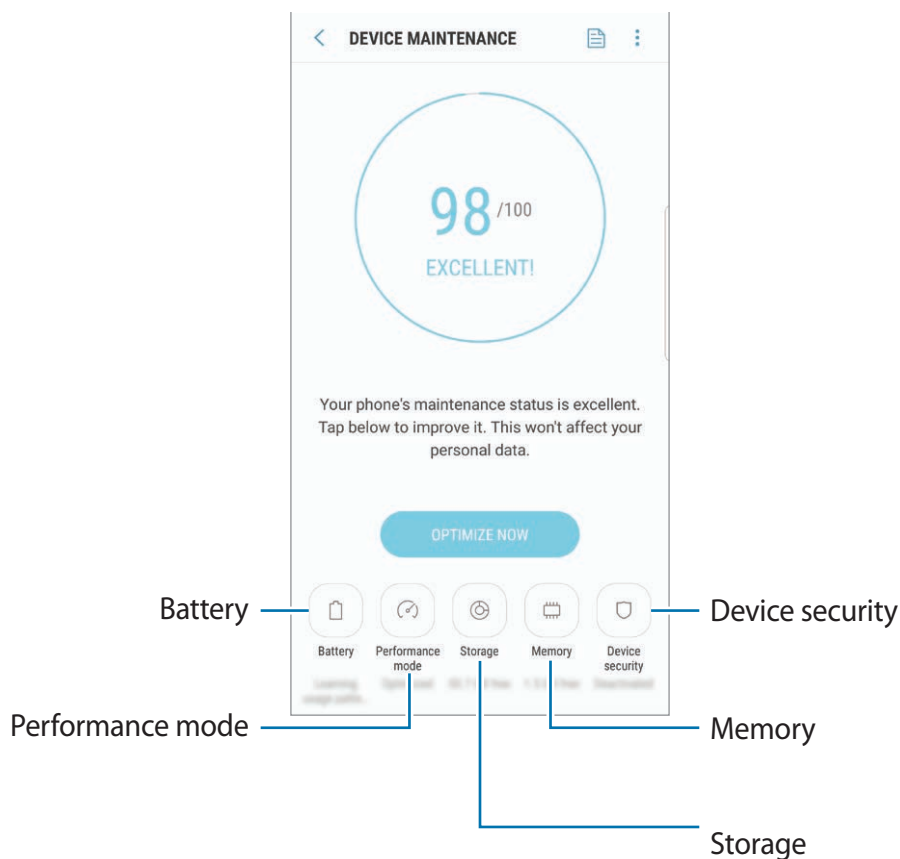

## Using the quick optimization feature

On the Settings screen, tap **Device maintenance** → **FIX NOW** or **OPTIMIZE NOW**.

The quick optimization feature improves device performance through the following actions.

- Clearing some memory.
- Deleting unnecessary files and closing apps running in the background.
- Managing abnormal battery usage.
- Scanning for crashed apps and malware.

## Battery

Check the remaining battery power and time to use the device. For devices with low battery levels, conserve battery power by activating power saving features.

On the Settings screen, tap **Device maintenance** → **Battery**.





- Estimated battery life is the time remaining before the battery power runs out. Usage time left may vary depending on your device settings and operating conditions.
- You may not receive notifications from some apps that use power saving mode.

## Power saving mode

- **MID**: Activate power saving mode to extend the battery's usage time.
- **MAX**: In maximum power saving mode, the device decreases battery consumption by applying the dark theme and limiting the apps and features available. Network connections, except for the mobile network, will be deactivated.

## Managing the battery

You can save battery power by preventing apps that are running in the background from using battery power when they are not being used. Tick apps from the apps list and tap **SAVE POWER**. Also, tap  → **Advanced settings** and set the **App power monitor** options.

You can set the device to charge the battery more quickly. Tap  → **Advanced settings** and tap the **Fast cable charging** switch to activate it.

## Performance mode

Change the device's performance mode according to your usage, such as playing games or music, to get the best performance.

On the Settings screen, tap **Device maintenance** → **Performance mode**.

- **Optimized (recommended):** Balance battery life and screen resolution for everyday use.
- **Game:** Enhance your gaming experience by making games run more smoothly.
- **Entertainment:** Apply ultra high quality sound, enhanced images, and maximum display settings to enjoy your music and videos more.
- **High performance:** Apply the highest quality display settings.



Battery power consumption will increase depending on the mode.

## Storage

Check the status of the used and available storage space.

On the Settings screen, tap **Device maintenance** → **Storage**.



- The actual available capacity of the internal storage is less than the specified capacity because the operating system and default apps occupy part of the space. The available capacity may change when you update the device.
- You can view the available capacity of the internal storage in the Specification section for your device on the Samsung website.

## Managing storage

To delete residual files, such as cache, tap **CLEAN NOW**. To delete files or uninstall apps that you do not use any more, select a category under **USER DATA**. Then, tick items to select and tap **DELETE** or **UNINSTALL**.

## Memory

On the Settings screen, tap **Device maintenance** → **Memory**.

To speed up your device by stopping apps running in the background, tick apps from the apps list, and tap **CLEAN NOW**.

## Device security

Check the device's security status. This feature scans your device for malware.

On the Settings screen, tap **Device maintenance** → **Device security** → **SCAN PHONE**.

## Apps

Manage the device's apps and change their settings. You can view the apps' usage information, change their notification or permission settings, or uninstall or disable unnecessary apps.

On the Settings screen, tap **Apps**.

## Lock screen and security

### Options

Change the settings for securing the device.

On the Settings screen, tap **Lock screen and security**.



The available options may vary depending on the screen lock method selected.

- **Screen lock type:** Change the screen lock method.
- **Smart Lock:** Set the device to unlock itself when trusted locations or devices are detected. Refer to [Smart Lock](#) for more information.
- **Secure lock settings:** Change screen lock settings for the selected lock method.
- **Intelligent Scan:** Register both your face and irises to the device to unlock the screen more conveniently. Refer to [Intelligent Scan](#) for more information.
- **Face Recognition:** Set the device to unlock the screen by recognizing your face. Refer to [Face recognition](#) for more information.
- **Iris Scanner:** Register your irises to unlock the screen. Refer to [Iris recognition](#) for more information.



- **Fingerprint Scanner:** Register your fingerprints to unlock the screen. Refer to [Fingerprint recognition](#) for more information.
- **Always On Display:** Set the device to display information while the screen is turned off. Refer to [Always On Display](#) for more information.
- **Clock and FaceWidgets:** Change the settings of the items displayed on the Always On Display or the locked screen.
- **Notifications:** Set whether or not to show notifications on the Always On Display or the locked screen and select which notifications to display.
- **App shortcuts:** Select apps to display shortcuts to them on the locked screen.
- **Google Play Protect:** Set the device to check for harmful apps and behaviour and warn about potential harm and remove them.
- **Find My Mobile:** Activate or deactivate the Find My Mobile feature. Access the Find My Mobile website ([findmymobile.samsung.com](http://findmymobile.samsung.com)) to track and control your lost or stolen device.

You can also allow the Google location service to provide more accurate information about the location of your device.

- **Security update:** View the version of your device's security system and check for updates.
- **Samsung Pass:** Verify your identity easily and securely via your biometric data. Refer to [Samsung Pass](#) for more information.
- **Secure Folder:** Create a secure folder to protect your private content and apps from others. Refer to [Secure Folder](#) for more information.
- **App permission monitor:** Set to receive notifications when the permissions you select are used by apps that you are not using. You can manage the settings of each app and view their permission usage history.
- **Secure startup:** Protect your device by setting it to require a screen unlock code when turning on the device. You must enter the unlock code to start the device and receive messages and notifications.
- **Encrypt SD card:** Set the device to encrypt files on a memory card.



If you reset your device to the factory defaults with this setting enabled, the device will not be able to read your encrypted files. Disable this setting before resetting the device.

- **Other security settings:** Configure additional security settings.

## Smart Lock

You can set the device to unlock itself and remain unlocked when trusted locations or devices are detected.

For example, if you have set your home as a trusted location, when you get home your device will detect the location and automatically unlock itself.



- This feature will be available to use after you set a screen lock method.
- If you do not use your device for four hours or when you turn on the device, you must unlock the screen using the pattern, PIN, or password you set.

- 1 On the Settings screen, tap **Lock screen and security** → **Smart Lock**.
- 2 Unlock the screen using the preset screen lock method.
- 3 Select an option and follow the on-screen instructions to complete the setting.

## Intelligent Scan

By using both your face and irises, you can easily and conveniently unlock the screen and verify your identity.



- This feature may not be available depending on the region or service provider.
- If you use Intelligent Scan as a screen lock method, your face and irises cannot be used to unlock the screen for the first time after turning on the device. To use the device, you must unlock the screen using the pattern, PIN, or password you set when registering your face and irises. Be careful not to forget your pattern, PIN, or password.
- If your irises are not recognized, unlock the device using the pattern, PIN, or password you set when registering the irises, and then re-register your irises. If your pattern, PIN, or password is forgotten, you will not be able to use the device if you do not reset it. Samsung is not responsible for any data loss or inconvenience caused by forgotten unlock codes.
- If you change the screen lock method to **Swipe** or **None**, which are not secure, all of your biometric data will be deleted. If you want to use your biometric data in apps or features, such as **Samsung Pass** and **Samsung Pay**, you must register your biometric data again.



## Precautions for using Intelligent Scan

Before using Intelligent Scan, keep the following precautions in mind.

- To protect your eyes, keep the screen at least 20 cm away from your face when using iris recognition.
- If you attach screen protectors (privacy protection films, tempered glass protectors, etc.), the recognition may fail.
- Do not use this feature with infants. Doing so may damage their eyesight.
- Anyone who has experienced dizziness, seizures, loss of awareness, blackouts, or other symptoms linked to an epileptic condition, or has a family history of such symptoms or conditions, should consult a doctor before using this feature.
- Intelligent Scan is not intended for any diagnostic, therapeutic, or preventative medical purposes.
- Your phone could be unlocked by someone that looks like you.
- Keep secure of your phone and do not let anyone else unlock your phone.

## For better face and iris recognition

The phone may not recognize your irises or face when:

- something prevents a good view of your face or eyes (e.g., glasses, contact lenses, hat, low eyelids, recent eye surgery, disease, dirt, damage to the camera, or excessive movement).
- the lighting is very different from when you recorded your face or irises (e.g., direct sunlight, or much darker surroundings).

## Registering irises and face

- 1 On the Settings screen, tap **Lock screen and security** → **Intelligent Scan**.
- 2 Unlock the screen using the preset screen lock method.  
If you have not set a screen lock method, create one.

**3** Read the on-screen instructions and tap **CONTINUE**.

**4** Register your face and irises.

For more information, refer to [Face recognition](#) and [Iris recognition](#).

When an intelligent scan unlock screen appears, tap **TURN ON** to use your face and irises to unlock the screen.

## Deleting registered face and iris data

You can delete face and iris data that you have registered.

**1** On the Settings screen, tap **Lock screen and security** → **Intelligent Scan**.

**2** Unlock the screen using the preset screen lock method.

**3** Tap **Remove face and iris data**.

Once the registered face and iris data has been deleted, all the related features will also be deactivated.

## Unlocking the screen using Intelligent Scan

You can unlock the screen with your face and irises instead of using a pattern, PIN, or password.

**1** On the Settings screen, tap **Lock screen and security** → **Intelligent Scan**.

**2** Unlock the screen using the preset screen lock method.

**3** Tap the **Intelligent Scan unlock** switch to activate it.

**4** On the locked screen, look at the screen.

When your face and irises are recognized, you can unlock the screen without using any additional screen lock method. If your face and irises are not recognized, use the preset screen lock method.

## Face recognition

You can set the device to unlock the screen by recognizing your face.



- If you use your face as a screen lock method, your face cannot be used to unlock the screen for the first time after turning on the device. To use the device, you must unlock the screen using the pattern, PIN, or password you set when registering the face. Be careful not to forget your pattern, PIN, or password.
- If you change the screen lock method to **Swipe** or **None**, which are not secure, all of your biometric data will be deleted. If you want to use your biometric data in apps or features, such as **Samsung Pass** and **Samsung Pay**, you must register your biometric data again.



### Precautions for using face recognition

Before using the face recognition to unlock your device, keep the following precautions in mind.

- Your device could be unlocked by someone that looks like your image.
- Face recognition is less secure than Pattern, PIN, or Password.

### For better face recognition

Consider the following when using face recognition:

- Consider the conditions when registering, such as wearing glasses, hats, masks, beards, or heavy makeup
- Ensure that you are in a well-lit area and that the camera lens is clean when registering
- Ensure your image is not blurry for better match results

### Registering your face

For better face registration, register your face indoors and out of direct sunlight.

- 1 On the Settings screen, tap **Lock screen and security** → **Face Recognition**.
- 2 Unlock the screen using the preset screen lock method.  
If you have not set a screen lock method, create one.

- 3 Read the on-screen instructions and tap **CONTINUE**.
- 4 Hold the device with the screen facing towards you and look at the screen.

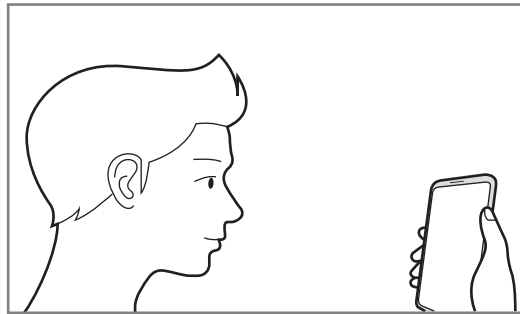

- 5 Position your face inside the circle on the screen.  
The camera will scan your face.



If unlocking the screen with your face is not working properly, tap **Remove face data** to remove your registered face and register your face again.

## Deleting the registered face data

You can delete face data that you have registered.

- 1 On the Settings screen, tap **Lock screen and security** → **Face Recognition**.
- 2 Unlock the screen using the preset screen lock method.
- 3 Tap **Remove face data**.  
Once the registered face is deleted, all the related features will also be deactivated.

## Unlocking the screen with your face

You can unlock the screen with your face instead of using a pattern, PIN, or password.

- 1 On the Settings screen, tap **Lock screen and security** → **Face Recognition**.
- 2 Unlock the screen using the preset screen lock method.

3 Tap the **Face unlock** switch to activate it.



If you want to reduce the possibility of recognizing faces in photos or videos, tap the **Faster recognition** switch to deactivate it. This may decrease the face recognition speed.

4 On the locked screen, look at the screen.

When your face is recognized, you can unlock the screen without using any additional screen lock method. If your face is not recognized, use the preset screen lock method.

## Iris recognition

The iris recognition feature uses the unique characteristics of your irises, such as their shape and pattern, to strengthen the security of your device. Your iris data can be used for various authentication purposes. After registering your irises, you can set the device to use your irises for the following features:

- Samsung Pass (Samsung account verification and web sign-in)
- Samsung Pay
- Screen lock
- Secure Folder



- This feature may not be available depending on the region or service provider.
- If you use your iris as a screen lock method, your irises cannot be used to unlock the screen for the first time after turning on the device. To use the device, you must unlock the screen using the pattern, PIN, or password you set when registering the irises. Be careful not to forget your pattern, PIN, or password.
- If your irises are not recognized, unlock the device using the pattern, PIN, or password you set when registering the irises, and then re-register your irises. If your pattern, PIN, or password is forgotten, you will not be able to use the device if you do not reset it. Samsung is not responsible for any data loss or inconvenience caused by forgotten unlock codes.
- If you change the screen lock method to **Swipe** or **None**, which are not secure, all of your biometric data will be deleted. If you want to use your biometric data in apps or features, such as **Samsung Pass** and **Samsung Pay**, you must register your biometric data again.



## Precautions for using iris recognition

Before using the iris recognition feature, camera, and LED, keep the following precautions in mind.

- To protect your eyes, keep the screen at least 20 cm away from your face when using iris recognition.
- If you attach screen protectors (privacy protection films, tempered glass protectors, etc.), the recognition may fail.
- Do not use iris recognition with infants. Doing so may damage their eyesight.
- Anyone who has experienced dizziness, seizures, loss of awareness, blackouts, or other symptoms linked to an epileptic condition, or has a family history of such symptoms or conditions, should consult a doctor before using iris recognition.
- The iris scanner is not intended for use as a medical device; biometric data collected and stored locally by the iris scanner is not intended for any diagnostic, therapeutic, or preventative medical purposes.

Alternative security options are available on your device. Please follow all the instructions for the use of this feature.

## For better iris recognition

The phone may not recognize your eyes when:

- Something prevents the camera from getting a good view of your irises (e.g., glasses, glare, low eyelids, recent eye surgery, or a medical condition).
- The lighting is very different from when you recorded your irises (e.g., direct sunlight, or much darker surroundings).



Hold your device about 25-35 cm away from your face with the screen facing towards you.

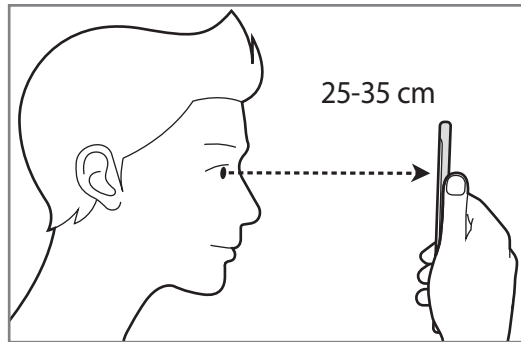

## Registering irises



The device can save the iris data of one person only. You cannot register more than one set of irises.

- 1 On the Settings screen, tap **Lock screen and security** → **Iris Scanner**.
- 2 Unlock the screen using the preset screen lock method.  
If you have not set a screen lock method, create one.
- 3 Read the on-screen instructions and tap **CONTINUE**.  
To register only one iris of your eyes, tap **Register just one iris**.
- 4 Hold the device with the screen facing towards you and look at the screen.

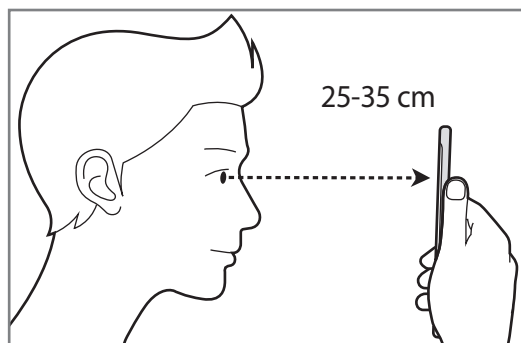

- 5 Position your eyes inside the circles on the screen and open your eyes wide.  
The iris recognition camera will scan your irises.  
When an iris unlock screen appears, tap **TURN ON** to use your irises to unlock the screen.

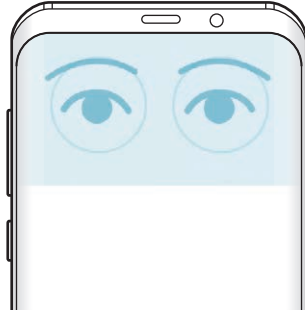

## Deleting registered iris data

You can delete iris data that you have registered.

- 1 On the Settings screen, tap **Lock screen and security** → **Iris Scanner**.
- 2 Unlock the screen using the preset screen lock method.
- 3 Tap **Remove iris data**.  
Once the registered iris data has been deleted, all the related features will also be deactivated.

## Using Samsung Pass

When you register your irises to Samsung Pass, you can use them to easily verify your identity or sign in to websites. Refer to [Samsung Pass](#) for more information.

## Using irises with Samsung Pay

You can use irises with Samsung Pay to make payments quickly and securely. Refer to [Samsung Pay](#) for more information.



Samsung Pay may not be available depending on the region or service provider.

## Unlocking the screen with your irises

You can unlock the screen with your irises instead of using a pattern, PIN, or password.

- 1 On the Settings screen, tap **Lock screen and security** → **Iris Scanner**.
- 2 Unlock the screen using the preset screen lock method.
- 3 Tap the **Iris unlock** switch to activate it.
- 4 On the locked screen, swipe in any direction and position your eyes inside the circles on the screen to scan your irises.

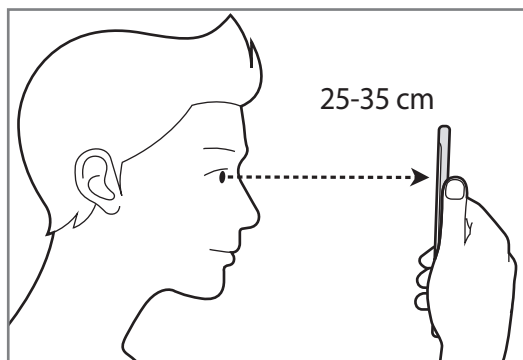

To unlock the screen using iris recognition, without swiping on the locked screen, tap **Iris unlock when screen turns on** switch to activate it.

## Fingerprint recognition

In order for fingerprint recognition to function, your fingerprint information needs to be registered and stored in your device. After registering, you can set the device to use your fingerprint for the features below:

- Samsung Pass (Samsung account verification and web sign-in)
- Samsung Pay
- Screen lock
- Secure Folder



- This feature may not be available depending on the region or service provider.
- Fingerprint recognition uses the unique characteristics of each fingerprint to enhance the security of your device. The likelihood of the fingerprint sensor confusing two different fingerprints is very low. However, in rare cases where separate fingerprints are very similar the sensor may recognize them as identical.
- If you use your fingerprint as a screen lock method, your fingerprint cannot be used to unlock the screen for the first time after turning on the device. To use the device, you must unlock the screen using the pattern, PIN, or password you set when registering the fingerprint. Be careful not to forget your pattern, PIN, or password.
- If your fingerprint is not recognized, unlock the device using the pattern, PIN, or password you set when registering the fingerprint, and then re-register your fingerprints. If your pattern, PIN, or password is forgotten, you will not be able to use the device if you do not reset it. Samsung is not responsible for any data loss or inconvenience caused by forgotten unlock codes.
- If you change the screen lock method to **Swipe** or **None**, which are not secure, all of your biometric data will be deleted. If you want to use your biometric data in apps or features, such as **Samsung Pass** and **Samsung Pay**, you must register your biometric data again.

## For better fingerprint recognition

When you scan your fingerprints on the device, be aware of the following conditions that may affect the feature's performance:

- The fingerprint recognition sensor recognizes fingerprints. Ensure that the fingerprint recognition sensor is not scratched or damaged by metal objects, such as coins, keys, and necklaces.
- Covering the fingerprint recognition sensor with protective films, stickers, or other accessories may decrease the fingerprint recognition rate. If the fingerprint recognition sensor is initially covered with a protective film, remove it before using the fingerprint recognition sensor.
- Ensure that the fingerprint recognition sensor and your fingers are clean and dry.
- The device may not recognize fingerprints that are affected by wrinkles or scars.
- The device may not recognize fingerprints from small or thin fingers.
- If you bend your finger or use a fingertip, the device may not recognize your fingerprints. Make sure to cover the entire fingerprint recognition sensor with your finger.
- To improve recognition performance, register fingerprints of the hand used most often to perform tasks on the device.
- In dry environments, static electricity can build up in the device. Avoid using this feature in dry environments or before using the feature, discharge static electricity by touching a metal object.

## Registering fingerprints

- 1 On the Settings screen, tap **Lock screen and security** → **Fingerprint Scanner**.
- 2 Unlock the screen using the preset screen lock method.  
If you have not set a screen lock method, create one.

- 3 Swipe your finger downwards over the fingerprint recognition sensor.

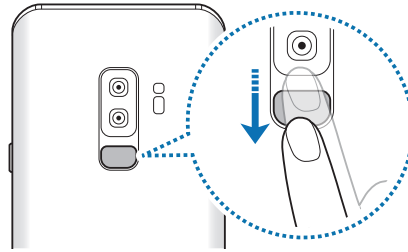

Repeat this action until the fingerprint is registered. When you are finished registering your fingerprints, tap **DONE**.

When a fingerprint lock screen appears, tap **TURN ON** to use your fingerprint to unlock the screen.

## Deleting registered fingerprints

You can delete registered fingerprints.

- 1 On the Settings screen, tap **Lock screen and security** → **Fingerprint Scanner**.
- 2 Unlock the screen using the preset screen lock method.
- 3 Tap **EDIT**.
- 4 Tick fingerprints to delete and tap **REMOVE**.

## Using Samsung Pass

When you register your fingerprints to Samsung Pass, you can use them to easily verify your identity or sign in to websites. Refer to [Samsung Pass](#) for more information.

## Using fingerprints with Samsung Pay

You can use fingerprints with Samsung Pay to make payments quickly and securely. Refer to [Samsung Pay](#) for more information.



Samsung Pay may not be available depending on the region or service provider.

## Unlocking the screen with your fingerprints

You can unlock the screen with your fingerprint instead of using a pattern, PIN, or password.

- 1 On the Settings screen, tap **Lock screen and security** → **Fingerprint Scanner**.
- 2 Unlock the screen using the preset screen lock method.
- 3 Tap the **Fingerprint unlock** switch to activate it.
- 4 On the locked screen, place your finger on the fingerprint recognition sensor and scan your fingerprint.

## Samsung Pass

Samsung Pass allows you to sign in to your Samsung account, websites, or apps more easily and securely via your biometric data, such as fingerprints or irises, rather than entering your login information.

Register your biometric data to Samsung Pass and set to sign in to supported websites or apps using the data via Samsung Pass.



- To use this feature, your device must be connected to a Wi-Fi or mobile network.
- To use this feature, you must register and sign in to your Samsung account. For more information, refer to [Samsung account](#).
- The website sign-in feature is only available for websites that you access via the **Internet** app. Some websites may not support this feature.

## Registering Samsung Pass

Before using Samsung Pass, register your biometric data to Samsung Pass.

- 1 On the Settings screen, tap **Lock screen and security** → **Samsung Pass**.
- 2 Read the on-screen instructions and tap **SIGN IN**.
- 3 Enter your Samsung account ID and password and tap **SIGN IN**.
- 4 Read and agree to the terms and conditions, and tap **NEXT**.
- 5 Tap **FINGERPRINTS** or **IRIS** and register your fingerprints or irises.  
Refer to [Fingerprint recognition](#) or [Iris recognition](#) for more information.
- 6 Scan your fingerprint or irises and tap **NEXT** to complete the Samsung Pass registration.  
If the **Add to Home screen** option is ticked, the Samsung Pass icon will be added on the Home screen.

## Verifying the Samsung account password

You can use Samsung Pass to verify your Samsung account password. You can use your biometric data instead of entering your password, for example, when you purchase content from **Galaxy Apps**.

- 1 On the Settings screen, tap **Lock screen and security** → **Samsung Pass**.
- 2 Unlock the screen using the preset screen lock method.
- 3 Tap  → **Settings** → **Samsung account**, and then tap the **Use with Samsung Pass** switch to activate it.



## Using Samsung Pass to sign in to websites

You can use Samsung Pass to easily sign in to websites that support ID and password autofill.

- 1 Open a website that you want to sign in to.
- 2 Enter your user name and password, and then tap the website's sign in button.
- 3 When a pop-up window asking whether you want to save the sign-in information appears, tick **Sign in using biometrics via Samsung Pass** and tap **REMEMBER**.

You can now use the biometric data you registered to Samsung Pass when signing in to the website.

## Using Samsung Pass to sign in to apps

You can use Samsung Pass to easily sign in to apps that support ID and password autofill.



- 1 Open an app that you want to sign in to.
- 2 Enter your user name and password, and then tap the app's sign in button.
- 3 When a pop-up window asking whether you want to save the sign-in information appears, tap **SAVE**.

You can now use the biometric data you registered to Samsung Pass when signing in to the app.

## Managing sign-in information

View the list of websites and apps you have set to use Samsung Pass and manage your sign-in information.

- 1 On the Settings screen, tap **Lock screen and security** → **Samsung Pass**.
- 2 Unlock the screen using the preset screen lock method.

- 3 Select a website or app from the list.
- 4 Tap  → **Edit** and modify your ID, password, and the website's or app's name.  
To delete the website or app, tap  → **Delete**.

## Using Samsung Pass with websites and apps

When using websites or apps that support Samsung Pass, you can easily sign in with Samsung Pass.

To see the list of websites and apps that support Samsung Pass, open the Settings screen, tap **Lock screen and security** → **Samsung Pass**, and then select the site or app tab. If there are no websites or apps that support Samsung Pass, the site or app tab will not appear.



- Available websites and apps may vary depending on the region or service provider.
- Samsung is not responsible for any loss or inconvenience caused by signing in to websites or apps via Samsung Pass.

## Deleting your Samsung Pass data

You can delete your biometric data, web sign-in information, and app data registered to Samsung Pass with **Delete data**. Your agreement to the terms and conditions and your Samsung account will remain active.

- 1 On the Settings screen, tap **Lock screen and security** → **Samsung Pass**.
- 2 Unlock the screen using the preset screen lock method.
- 3 Tap  → **Settings** → **Delete data**.
- 4 Enter your Samsung password and tap **CONFIRM**.  
Your Samsung Pass data will be deleted.

## Secure Folder

Secure Folder protects your private content and apps, such as photos and contacts, from being accessed by others. You can keep your private content and apps secure even when the device is unlocked.

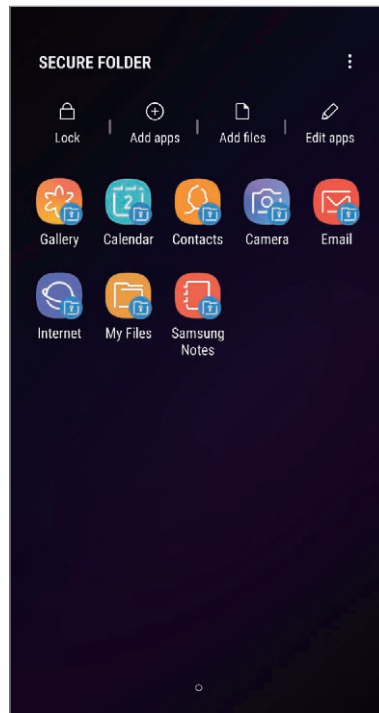

Secure Folder is a separate, secured storage area. The data in Secure Folder cannot be transferred to other devices via unapproved sharing methods, such as USB or Wi-Fi Direct. Attempting to customize the operating system or modifying software will cause Secure Folder to be automatically locked and inaccessible. Before saving data in Secure Folder, make sure to back up a copy of the data in another secure location.

### Setting up Secure Folder

- 1 Launch the **Secure Folder** app.  
Alternatively, launch the **Settings** app and tap **Lock screen and security** → **Secure Folder**.
- 2 Tap **START**.

- 3 Tap **SIGN IN** and sign in to your Samsung account.
- 4 Select a lock method to use for Secure Folder and follow the on-screen instructions to complete the setup.

To change the name or icon colour of Secure Folder, tap  → **Customize icon**.



- When you launch the **Secure Folder** app, you must unlock the app using your preset lock method.
- If you forget your Secure Folder unlock code, you can reset it using your Samsung account. Tap the reset button at the bottom of the locked screen, and enter your Samsung account password.

## Setting auto lock for Secure Folder

Set the device to automatically lock Secure Folder when it is not being used.

- 1 Launch the **Secure Folder** app and tap  → **Settings** → **Auto lock Secure Folder**.
- 2 Select a lock option.



To manually lock your Secure Folder, tap **Lock**.

## Moving content to Secure Folder

Move content, such as photos and contacts, to Secure Folder. The following actions are an example of moving an image from the default storage to Secure Folder.

- 1 Launch the **Secure Folder** app and tap **Add files**.
- 2 Tap **Images**, tick images to move, and then tap **DONE**.
- 3 Tap **MOVE**.

The selected items will be deleted from the original folder and moved to Secure Folder. To copy items, tap **COPY**.



The method for moving content may vary depending on the content type.

## Moving content from Secure Folder

Move content from Secure Folder to the corresponding app in the default storage. The following actions are an example of moving an image from Secure Folder to the default storage.

- 1 Launch the **Secure Folder** app and tap **Gallery**.
- 2 Select an image and tap **⋮** → **Move out of Secure Folder**.  
The selected items will be moved to **Gallery** in the default storage.

## Adding apps

Add an app to use in Secure Folder.

- 1 Launch the **Secure Folder** app and tap **Add apps**.
- 2 Tick one or more apps installed on the device and tap **ADD**.  
To install apps from **Play Store** or **Galaxy Apps**, tap **DOWNLOAD FROM PLAY STORE** or **DOWNLOAD FROM GALAXY APPS**.

## Removing apps from Secure Folder

Tap **Edit apps**, tick apps, and then tap **Uninstall**.

## Adding accounts

Add your Samsung and Google accounts, or other accounts, to sync with the apps in Secure Folder.

- 1 Launch the **Secure Folder** app and tap **⋮** → **Settings** → **Accounts** → **Add account**.
- 2 Select an account service.
- 3 Follow the on-screen instructions to complete the account setup.

## Hiding Secure Folder

You can hide the Secure Folder shortcut from the Apps screen.

Launch the **Secure Folder** app, tap **⋮** → **Settings**, and then tap the **Show Secure Folder** switch to deactivate it.

Alternatively, drag the status bar downwards to open the notification panel. Then, swipe downwards on the notification panel and tap **Secure Folder** to deactivate the feature.

## Backing up and restoring Secure Folder

Back up content and apps in Secure Folder to Samsung Cloud using your Samsung account and restore them later.

### Backing up data

- 1 Launch the **Secure Folder** app and tap **⋮** → **Settings** → **Backup and restore**.
- 2 Tap **Add account** and register and sign in to your Samsung account.
- 3 Tap **Back up Secure Folder data**.
- 4 Tick items you want to back up and tap **BACK UP NOW**.  
Data will be backed up to Samsung Cloud.

### Restoring data

- 1 Launch the **Secure Folder** app and tap **⋮** → **Settings** → **Backup and restore**.
- 2 Tap **Restore**.
- 3 Select a device and the data types you want to restore and tap **RESTORE NOW**.  
Backed up data will be restored to your device.

## Uninstalling Secure Folder

You can uninstall Secure Folder, including the content and apps in it.

Launch the **Secure Folder** app and tap  → **Settings** → **More settings** → **Uninstall**.

To back up content before uninstalling Secure Folder, tick **Move media files out of Secure Folder** and tap **UNINSTALL**. To access data backed from Secure Folder, open the **Samsung** folder, launch the **My Files** app, and then tap **Internal storage** → **Secure Folder**.



Notes saved in **Samsung Notes** will not be backed up.

## Cloud and accounts

### Options

Sync, back up, or restore your device's data using Samsung Cloud. You can also register and manage accounts, such as your Samsung account or Google account, or transfer data to or from other devices via Smart Switch.

On the Settings screen, tap **Cloud and accounts**.



Regularly back up your data to a safe location, such as Samsung Cloud or a computer, so that you can restore it if the data is corrupted or lost due to an unintended factory data reset.

- **Samsung Cloud:** Manage the content that you want to store securely in Samsung Cloud. Check the usage status of your Samsung Cloud storage, and sync, back up, and restore your data. Refer to [Samsung Cloud](#) for more information.
- **Accounts:** Add your Samsung and Google accounts, or other accounts, to sync with.
- **Backup and restore:** Keep your personal information, app data, and settings safe on your device. You can back up your sensitive information and access it later. You must sign in to your Google or Samsung account to back up or restore data.
- **Smart Switch:** Launch Smart Switch and transfer data from your previous device. Refer to [Smart Switch](#) for more information.

## Samsung Cloud

Back up data from your previous device to Samsung Cloud and restore the data to your new device. You must register and sign in to your Samsung account to use Samsung Cloud. Refer to [Samsung account](#) for more information.

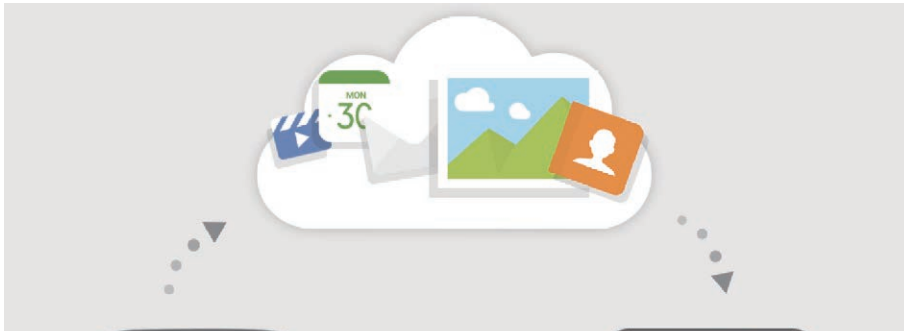

### Backing up data

- 1 On your previous device, sign in to your Samsung account.
  - 2 Launch the **Settings** app, select the backup option, and back up your data.
- If your device supports Samsung Cloud, launch the **Settings** app, tap **Cloud and accounts** → **Samsung Cloud**, select your device under **BACKUP AND RESTORE**, tap **Back up**, and then back up your data.
  - The data backup method may vary depending on your model.
  - Some data will not be backed up. To check which data will be backed up, launch the **Settings** app, tap **Cloud and accounts** → **Samsung Cloud**, select your device under **BACKUP AND RESTORE**, and then tap **Back up**.

### Restoring data

- 1 On your new device, launch the **Settings** app and tap **Cloud and accounts** → **Samsung Cloud**.
- 2 Select your previous device under **BACKUP AND RESTORE** and tap **Restore data**.
- 3 Tick the data types you want to restore and tap **RESTORE**.



## Syncing data

You can sync data saved in your device with Samsung Cloud and access it from other devices.

- 1 On your new device, launch the **Settings** app and tap **Cloud and accounts** → **Samsung Cloud**.
- 2 Tap  → **Settings** → **Sync settings**.
- 3 Tap the switches next to the items you want to sync with.

## Checking data

You can check the saved items and used memory of your Samsung Cloud. Launch the **Settings** app and tap **Cloud and accounts** → **Samsung Cloud**.

- You can immediately check your used memory and saved items, such as, **GALLERY**, **SAMSUNG NOTES**, and **SAMSUNG CLOUD DRIVE**. Tap each card and enter the next page. You can change the settings or check the saved data.
- You can check the backup data in your Samsung account by using the **BACKUP AND RESTORE** option. Select your device and tap **Restore data**.

## Smart Switch

Transfer data between mobile devices via Smart Switch.

On the Settings screen, tap **Cloud and accounts** → **Smart Switch**.

### Transferring data using a USB connector (USB Type-C)

You can connect your previous device to your device with the USB connector (USB Type-C) and a USB cable to easily and quickly transfer data.

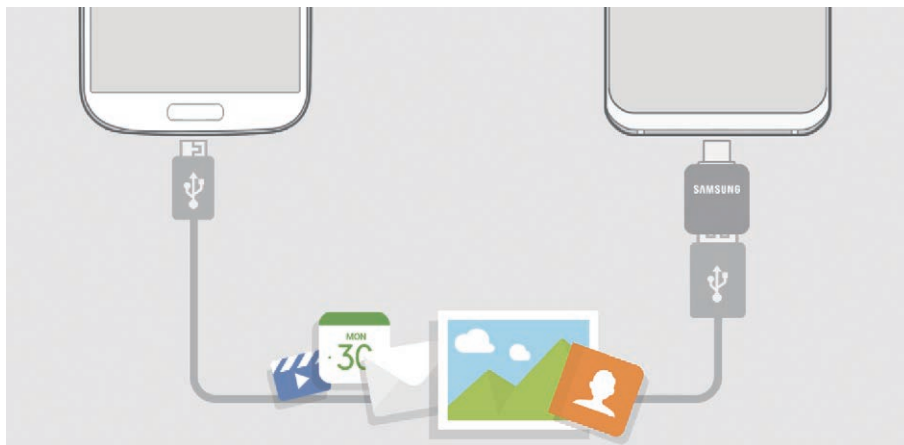

- 1 Plug the USB connector (USB Type-C) into the multipurpose jack of your device.
- 2 Connect your device and the previous device using the previous device's USB cable.

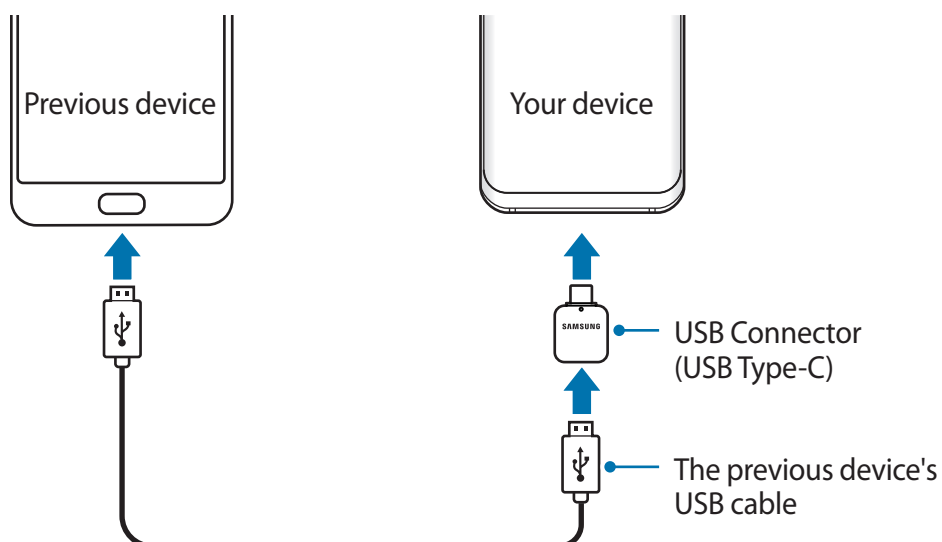

3 When the app selection pop-up window appears, tap **Smart Switch** → **RECEIVE**.

4 In the previous device, tap **ALLOW**.

If you do not have the app, download it from **Galaxy Apps** or **Play Store**.

Your device will recognize the previous device and a list of data you can transfer will appear.

5 Follow the on-screen instructions to transfer data from the previous device.

 Do not disconnect the USB cable or USB connector (USB Type-C) from the device when you are transferring files. Doing so may cause data loss or device damage.

 Transferring data increases the battery power consumption of your device. Ensure that your device is sufficiently charged before transferring data. If the battery power is low, data transfer may be interrupted.

## Transferring data wirelessly via Wi-Fi Direct

Transfer data from your previous device to your device wirelessly via Wi-Fi Direct.



1 On the previous device, launch Smart Switch.

If you do not have the app, download it from **Galaxy Apps** or **Play Store**.

2 On your device, launch the **Settings** app and tap **Cloud and accounts** → **Smart Switch**.

3 Place the devices near each other.

- 4 On the previous device, tap **WIRELESS** → **SEND** → **CONNECT**.
- 5 On your device, tap **WIRELESS** → **RECEIVE** and select the previous device type.
- 6 Follow the on-screen instructions to transfer data from your previous device.

## Transferring data using external storage

Transfer data using external storage, such as a microSD card.

- 1 Transfer data from your previous device to external storage.
- 2 Insert or connect the external storage device to your device.
- 3 On your device, launch the **Settings** app and tap **Cloud and accounts** → **Smart Switch** → **EXTERNAL STORAGE** → **RESTORE**.
- 4 Follow the on-screen instructions to transfer data from external storage.

## Transferring backup data from a computer

Transfer data between your device and a computer. You must download the Smart Switch computer version app from [www.samsung.com/smarts witch](http://www.samsung.com/smarts witch). Back up data from your previous device to a computer and import the data to your device.

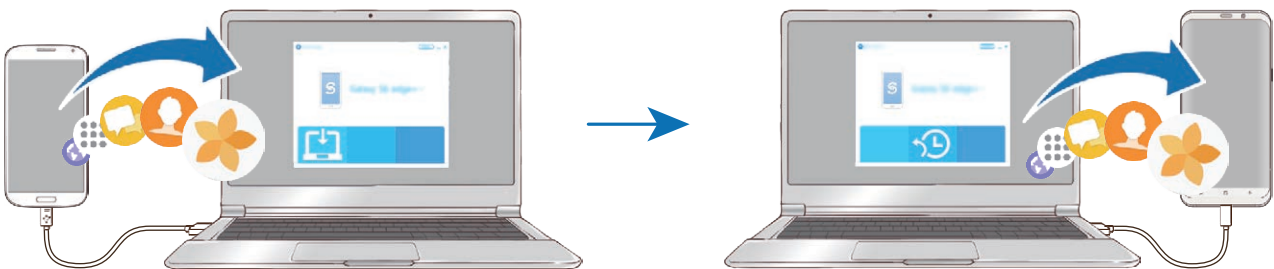

- 1 On the computer, visit [www.samsung.com/smartswitch](http://www.samsung.com/smartswitch) to download Smart Switch.
- 2 On the computer, launch Smart Switch.  
 If your previous device is not a Samsung device, back up data to a computer using a program provided by the device's manufacturer. Then, skip to step 5.
- 3 Connect your previous device to the computer using the device's USB cable.
- 4 On the computer, follow the on-screen instructions to back up data from the device. Then, disconnect your previous device from the computer.
- 5 Connect your device to the computer using the USB cable.
- 6 On the computer, follow the on-screen instructions to transfer data to your device.

### Viewing imported data

You can view the imported data on the same app from your previous device.

If your new device does not have the same apps to view or play the imported data, the data will be saved to a similar app. For example, if you import memos and your device does not have the Memo app, you can view the memos in the **Samsung Notes** app.

## Google

Configure settings for some features provided by Google.

On the Settings screen, tap **Google**.

## Accessibility

Configure various settings to improve accessibility to the device. Refer to [Accessibility](#) for more information.

On the Settings screen, tap **Accessibility**.

## General management

Customize your device's system settings or reset the device.

On the Settings screen, tap **General management**.

- **Language and input:** Select device languages and change settings, such as keyboards and voice input types. Some options may not be available depending on the selected language. Refer to [Adding device languages](#) for more information.
- **Date and time:** Access and alter the settings to control how the device displays the time and date.



If the battery remains fully discharged, the time and date is reset.

- **Contact us:** Ask questions or view frequently asked questions. Refer to [Samsung Members](#) for more information.
- **Report diagnostic information:** Set the device to automatically send the device's diagnostic and usage information to Samsung.
- **Marketing information:** Set whether to receive Samsung marketing information, such as special offers, membership benefits, and newsletters.
- **Reset:** Reset your device's settings or perform a factory data reset. You can reset all your settings and network settings. You can also set the device to restart at a preset time for device optimization.

## Adding device languages

You can add languages to use on your device.

- 1 On the Settings screen, tap **General management** → **Language and input** → **Language** → **Add language**.

To view all the languages that can be added, tap  → **All languages**.

- 2 Select a language to add.

- 3 To set the selected language as the default language, tap **SET AS DEFAULT**. To keep the current language setting, tap **KEEP CURRENT**.

The selected language will be added to your languages list. If you changed the default language, the selected language will be added to the top of the list.

To change the default language from your languages list, drag  next to a language and move it to the top of the list. Then, tap **APPLY**. If an app does not support the default language, the next supported language in the list will be used.

## Software update

Update your device's software via the firmware over-the-air (FOTA) service. You can also schedule software updates.

On the Settings screen, tap **Software update**.



If emergency software updates are released for your device's security and to block new types of security threats, they will be installed automatically without your agreement.

- **Download updates manually:** Check for and install updates manually.
- **Download updates automatically:** Set the device to download updates automatically when connected to a Wi-Fi network.
- **Scheduled software updates:** Set the device to install updates at a specified time.
- **Last update information:** View information about the last software update.

## Security update information

Security updates are provided to strengthen the security of your device and protect your personal information. For security updates for your model, visit [security.samsungmobile.com](https://security.samsungmobile.com).



The website supports only some languages.

## User manual

View help information to learn how to use the device and apps or configure important settings.

On the Settings screen, tap **User manual**.

## About phone

Access your device's information.

On the Settings screen, tap **About phone**.

To change your device's name, tap **EDIT**.

- **Status:** View various device information, such as the SIM card status, Wi-Fi MAC address, and serial number.
- **Legal information:** View legal information related to the device, such as safety information and the open source licence.
- **Software information:** View the device's software information, such as its operating system version and firmware version.
- **Battery information:** View the device's battery status and information.



# Appendix

## Accessibility

### About Accessibility

Improve accessibility with features that make the device easier to use for users who have impaired vision, hearing, and reduced dexterity.

Launch the **Settings** app and tap **Accessibility**.

### Voice Assistant (Voice feedback)

#### Activating or deactivating Voice Assistant

When you activate Voice Assistant, the device will start voice feedback. When you tap the selected feature once, the device will read the text on the screen aloud. Tapping the feature twice will activate the feature.

Launch the **Settings** app, tap **Accessibility** → **Vision** → **Voice Assistant**, and then tap the switch to activate it.

To deactivate Voice Assistant, tap the switch and tap anywhere on the screen twice quickly.

When you activate Voice Assistant for the first time, the tutorial will start after activation. You can replay it by tapping **Voice Assistant help**.



Some features are not available while you are using Voice Assistant.

## Controlling the screen with finger gestures

You can use various finger gestures to control the screen while you are using Voice Assistant.

### One finger gestures

- Tapping: Read aloud the item under your finger. To explore the screen, place a finger on the screen and move it on the screen.
- Tapping twice: Open the selected item. While selected items are read aloud, when you hear the item you want, release your finger from the item. Then, tap anywhere on the screen twice quickly.
- Double-tapping and holding the screen: Move an item or access an available option.
- Swiping to the left: Move to the previous item.
- Swiping to the right: Move to the next item.
- Swiping upwards or downwards: Change the most recent contextual menu settings.
- Swiping to the left then right in one motion: Scroll up the screen.
- Swiping to the right then left in one motion: Scroll down the screen.
- Swiping upwards then downwards in one motion: Move to the first item on the screen.
- Swiping downwards then upwards in one motion: Move to the last item on the screen.

### Two finger gestures

- Tapping twice: Start, pause, or resume the current action.
- Tapping three times: Check the current time, remaining battery power, and more. To change items that are read aloud, launch the **Settings** app and tap **Accessibility** → **Vision** → **Voice Assistant** → **SETTINGS** → **Status bar information**.
- Tapping four times: Activate or deactivate voice feedback.
- Swiping to the left: Move to the next page.
- Swiping to the right: Return to the previous page.
- Swiping upwards: Scroll down the list.
- Swiping downwards: Scroll up the list.

- Swipe upwards or downwards on the Home screen: Open the Apps screen.
- Swipe upwards or downwards on the Apps screen: Return to the Home screen.
- Swiping in any direction on the locked screen: Unlock the screen.
- Swiping downwards from the top of the screen: Open the notification panel.

### Three finger gestures

- Tapping: Start reading items aloud from the top.
- Tapping twice: Start reading from the next item.
- Tapping three times: Read the last selected text and copy it to the clipboard.
- Swiping to the left or right: Open the contextual menu and scroll through the options.
- Swiping upwards or downwards: Change the text reading and selecting granularity.
- Swiping upwards then downwards in one motion: Return to the previous screen.
- Swiping downwards then upwards in one motion: Return to the Home screen.

### Four finger gestures

- Tapping: Return to the previous screen.
- Tapping twice: Return to the Home screen.
- Tapping three times: Open the list of recent apps.

### Using the contextual menu

While you are using Voice Assistant, swipe to the left or right with three fingers. The contextual menu will appear and the device will read the options aloud. Swipe to the left or right with three fingers to scroll through the options. When you hear the option you want, swipe upwards or downwards to use the option or adjust the settings for the option. For example, when you hear **Speech volume**, you can adjust the volume by swiping upwards or downwards.

## Adding and managing image labels

You can assign labels to images on the screen. The device reads aloud the labels when the images are selected. Add labels to unlabelled images by tapping the screen twice with three fingers and holding.

To manage the labels, launch the **Settings** app and tap **Accessibility** → **Vision** → **Voice Assistant** → **SETTINGS** → **Manage custom labels**.

## Configuring settings for Voice Assistant

Configure settings for Voice Assistant for your convenience.

Launch the **Settings** app and tap **Accessibility** → **Vision** → **Voice Assistant** → **SETTINGS**.

- **Speech volume:** Select the volume level for voice feedback.
- **Text-to-speech:** Change the settings for text-to-speech features used when Voice Assistant is activated, such as languages, speed, and more.
- **Pitch changes:** Set the device to read aloud text with an altered pitch while using a keyboard.
- **Read keyboard input aloud:** Set the device to read aloud the item under your finger while using a keyboard.
- **Speak while screen is off:** Set the device to read aloud notifications when the screen is turned off.
- **Mute with proximity sensor:** Set the device to pause voice feedback when you place your hand over the sensor at the top of the device.
- **Shake for continuous reading:** Set the device to read aloud the text displayed on the screen when you shake the device. You can select from various shaking speeds.
- **Read out caller ID:** Set the device to read the caller's name aloud when you have an incoming call.
- **Phonetic alphabet:** Set the device to say a word that starts with the letter you tap and hold on the keyboard.

- **Usage hints:** Set the device to read usage hints aloud when you select an item by swiping.
- **Vibration feedback:** Set the device to vibrate when you control the screen, such as selecting an item.
- **Sound feedback:** Set the device to emit a sound when you control the screen, such as selecting an item.
- **Focus on speech audio:** Set the device to turn the media volume down when the device reads an item aloud.
- **Sound feedback volume:** Adjust the volume that sound is played when you touch the screen to control it. This feature is available when **Sound feedback** is activated.
- **Large cursor:** Set the device to thicken the border of the square cursor that appears when you tap items.
- **Cursor colour:** Select a colour of the square cursor that appears when you tap items.
- **Quick menu:** Select contextual menu options to display when you swipe to the left or right with three fingers.
- **Manage custom labels:** Manage the labels you added.
- **Keyboard shortcuts:** Set key shortcuts to use when using an external keyboard.
- **Status bar information:** Select items to read aloud when you tap the screen three times with two fingers.
- **Developer options:** Set options for app development.

## Using the device with the screen turned off

For privacy, you can set the device to function normally with the screen off. The screen will not turn on when you press keys or tap the screen. Currently activated features do not turn off when the screen is off.

Launch the **Settings** app, tap **Accessibility** → **Vision**, and then tap the **Dark screen** switch to activate it. You can activate or deactivate this feature by pressing the Power key twice quickly.

## Entering text using the keyboard

To display the keyboard, tap the text input field, and then tap anywhere on the screen twice quickly.

To activate the rapid key input feature, launch the **Settings** app, tap **Accessibility** → **Vision**, and then tap the **Rapid key input** switch to activate it.

When you touch the keyboard with your finger, the device reads aloud the character keys under your finger. When you hear the character you want, release your finger from the screen to select it. The character is entered and the device reads the text aloud.

If **Rapid key input** is not activated, release your finger from the character you want, and then tap anywhere on the screen twice quickly.

## Entering additional characters

Tap and hold a key on the keyboard to enter additional characters available for the key. A pop-up window appears above the key showing available characters. To select a character, drag your finger on the pop-up window until you hear the character you want, and release it.

## Vision

### Adding voice recordings to voice labels

You can use voice labels to distinguish objects of similar shape by attaching labels to them. You can record and assign a voice recording to an NFC-enabled voice label. The voice recording is played back when you place your device near the label.



Turn on the NFC feature before using this feature.

- 1 Launch the **Settings** app and tap **Accessibility** → **Vision** → **Voice Label**.

The voice recorder will launch.

- 2 Tap  to start recording. Speak into the microphone.

- 3 When you are finished recording, tap **DONE** to stop.

- 4 Hold the back of your device over the voice label.

The information in the voice recording will be written to the voice label.

### Changing the screen zoom and font

Change the screen zoom setting or font size and style.

Launch the **Settings** app and tap **Accessibility** → **Vision** → **Font and screen zoom**.

### Using the high contrast font

Adjust the colour and outline of fonts to increase the contrast between the text and the background.

Launch the **Settings** app, tap **Accessibility** → **Vision**, and then tap the **High contrast fonts** switch to activate it.

## Using the high contrast keyboard

Increase the size of the Samsung keyboard and change the key colours to increase the contrast between the text and the background.

Launch the **Settings** app, tap **Accessibility** → **Vision**, and then tap the **High contrast keyboard** switch to activate it.

## Displaying button shapes

Display button shapes with frames to make them stand out.

Launch the **Settings** app, tap **Accessibility** → **Vision**, and then tap the **Show button shapes** switch to activate it.

## Using a magnifier

Activate a magnifier to zoom in on the screen to view a larger version of the content.



Launch the **Settings** app, tap **Accessibility** → **Vision**, and then tap the **Magnifier window** switch to activate it. The magnifier will appear on the screen.

Drag the handle at the bottom of the magnifier to move the magnifier to where you want to zoom in on the screen.

## Magnifying the screen

Magnify the screen and zoom in on a specific area.

Launch the **Settings** app and tap **Accessibility** → **Vision** → **Magnification**.

- **Triple tap screen to magnify:** Zoom in by tapping the screen three times. To return to the normal view, tap the screen three times again.
- **Tap button to magnify:** Zoom in by tapping  on the navigation bar, and then tapping where you want to magnify the screen. To return to the normal view, tap .

To explore the screen, drag two or more fingers across the magnified screen.

To adjust zoom ratio, pinch two or more fingers on the magnified screen or spread them apart.



You can also temporarily magnify the screen by tapping the screen three times and holding. Or, tap , and then tap and hold the screen. While holding the screen, drag your finger to explore the screen. Release your finger to return to the normal view.



- Keyboards on the screen cannot be magnified.
- When this feature is activated, the performance of some apps may be affected.

## Enlarging mouse or touchpad pointers

Enlarge the pointer when using an external mouse or touchpad.

Launch the **Settings** app, tap **Accessibility** → **Vision**, and then tap the **Large mouse/touchpad pointer** switch to activate it.

## Reversing the display colours

Improve screen visibility to help users recognize text on the screen more easily.

Launch the **Settings** app, tap **Accessibility** → **Vision**, and then tap the **Negative colours** switch to activate it.

## Colour adjustment

Adjust how colours are displayed on the screen if you have difficulty in distinguishing colours. The device changes the colours into more recognizable colours.

Launch the **Settings** app, tap **Accessibility** → **Vision** → **Colour adjustment**, and then tap the switch to activate it. Select an option.

To adjust the intensity of colour, drag the adjustment bar under **INTENSITY**.

If you select **Personalized colour**, you can personalize the colour of the screen. Follow the on-screen instructions to complete the colour adjustment procedure.

## Colour lens

Adjust the screen colours if you have difficulty in reading the text.

Launch the **Settings** app, tap **Accessibility** → **Vision** → **Colour lens**, and then tap the switch to activate it. Select a colour you want.

To adjust the transparency level, drag the adjustment bar under **OPACITY**.

## Hearing

### Sound detectors

Set the device to vibrate when it detects your doorbell or a baby crying.



While this feature is enabled, the voice recognition will not operate.

### Baby crying detector

Launch the **Settings** app, tap **Accessibility** → **Hearing** → **Sound detectors**, and then tap the **Baby crying detector** switch to activate it. The device will vibrate when it detects sound and the alert will be saved as a log.

### Doorbell detector

- 1 Launch the **Settings** app, tap **Accessibility** → **Hearing** → **Sound detectors**, and then tap the **Doorbell detector** switch to activate it.
- 2 Tap ● to make a recording of your doorbell.  
The device will detect and record the doorbell.
- 3 Tap ● and ring your doorbell to check if it is recorded correctly. When the device detects the doorbell sound, tap **OK**.  
To change the doorbell sound, tap **Change doorbell sound**.  
The device will vibrate when it detects sound and the alert will be saved as a log.

### Setting light notification

Set the device to blink the flash or the screen when an alarm sounds or when you have notifications, such as incoming calls or new messages.

Launch the **Settings** app, tap **Accessibility** → **Hearing** → **Flash notification**, and then tap the switches next to the options you want to activate.

## Turning off all sounds

Set the device to mute all device sounds, such as media sounds, and the caller's voice during a call.

Launch the **Settings** app, tap **Accessibility** → **Hearing**, and then tap the **Mute all sounds** switch to activate it.

## Caption settings

Launch the **Settings** app, tap **Accessibility** → **Hearing** → **Samsung subtitles (CC)** or **Google subtitles (CC)**, and then tap the switch to activate it.

Select an option for configuring the caption settings.

## Adjusting the sound balance

Set the device to adjust the sound balance when using an earphone.

- 1 Connect an earphone to the device and wear it.
- 2 Launch the **Settings** app and tap **Accessibility** → **Hearing**.
- 3 Drag the adjustment bar under **Left/right sound balance** to the left or right and adjust the sound balance.

## Mono audio

Mono output combines stereo sound into one signal that is played through all earphone speakers. Use this if you have a hearing impairment or if a single earbud is more convenient.

Launch the **Settings** app, tap **Accessibility** → **Hearing**, and then tap the **Mono audio** switch to activate it.

## Dexterity and interaction

### Universal switch

You can control the touchscreen by connecting an external switch, by tapping the screen, or by using head movements and face gestures.

Launch the **Settings** app, tap **Accessibility** → **Dexterity and interaction** → **Universal switch**, and then tap the switch to activate it. If the universal switches are not registered on the device, tap **ADD SWITCH** and set switches to control the device.



To activate the universal switch feature, at least one switch must be registered on the device.

To set switches to control the device, tap **SETTINGS** → **Switches**.

To deactivate this feature, press the Power key and the Volume Up key simultaneously.

### Assistant menu

#### Displaying the assistive shortcut icon

Set the device to display the assistive shortcut icon for accessing apps, features, and settings. You can easily control the device by tapping the assistive menus in the icon.

- 1 Launch the **Settings** app and tap **Accessibility** → **Dexterity and interaction** → **Assistant menu**.

- 2 Tap the switch to activate it.

The assistive shortcut icon appears at the bottom right of the screen.

To adjust the assistant shortcut icon's transparency level, drag the adjustment bar under **Transparency**.

#### Accessing assistive menus







The assistive shortcut icon appears as a floating icon for easy access to the assistive menus from any screen.

When you tap the assistive shortcut icon, the icon expands slightly and the assistive menus appear on the icon. Tap the left or right arrow to move to other panels or swipe to the left or right to select other menus.

## Using the cursor

On the assistive menu, tap **Cursor**. You can control the screen using small finger movements on the touch area. Drag your finger on the touch area to move the cursor. Also, tap the screen to select items under the cursor.

Use the following options:

-  / : Scroll left or right on the screen.
-  / : Scroll up or down the screen.
- : Magnify the area where the cursor is located.
- : Move the touch area to another location.
- : Close the touch area.

To change the touch area and cursor settings, launch the **Settings** app and tap **Accessibility** → **Dexterity and interaction** → **Assistant menu**. Then, customize settings in **CURSOR AND SCREEN CONTROL**.

## Using enhanced assistive menus

Set the device to display enhanced assistive menus for selected apps.

Launch the **Settings** app, tap **Accessibility** → **Dexterity and interaction** → **Assistant menu** → **Assistant plus**, tap the switch to activate it, and then select apps.

## Easy screen turn on

Turn on the screen by moving your hand above the sensor at the top of the device. You can turn on the screen without pressing a key. When you use this feature, place the device on a flat surface with the screen facing upwards or hold the device securely to prevent it from moving.

Launch the **Settings** app, tap **Accessibility** → **Dexterity and interaction**, and then tap the **Easy screen turn on** switch to activate it.

## Touch and hold delay

Set the recognition time for tapping and holding the screen.

Launch the **Settings** app, tap **Accessibility** → **Dexterity and interaction** → **Touch and hold delay**, and then select an option.

## Click after pointer stops

Set the device to select an item automatically when you place the mouse pointer over the item.

Launch the **Settings** app, tap **Accessibility** → **Dexterity and interaction**, and then tap the **Click after pointer stops** switch to activate it.

## Interaction control

Activate interaction control mode to restrict the device's reaction to inputs while using apps.

- 1 Launch the **Settings** app and tap **Accessibility** → **Dexterity and interaction** → **Interaction control**.
- 2 Tap the switch to activate it.
- 3 Press and hold the Power key and the Volume Up key simultaneously while using an app.
- 4 Adjust the size of the frame or draw a line around an area that you want to restrict.
- 5 Tap **DONE**.

The device displays the restricted area. The restricted area will not react when you touch it and the device's keys will be disabled. However, you can enable functions for the Power key, Volume key, and keyboard in interaction control mode.

To deactivate interaction control mode, press and hold the Power key and the Volume Up key simultaneously.

To set the device to lock the screen after deactivating interaction control mode, launch the **Settings** screen, tap **Accessibility** → **Dexterity and interaction** → **Interaction control**, and then tap the **Use screen lock when turned off** switch to activate it.

## Setting text-to-speech features

Change the settings for text-to-speech features used when Voice Assistant is activated, such as languages, speed, and more.

Launch the **Settings** app, tap **Accessibility** → **Text-to-speech**, and then use the following functions:

- **Preferred engine:** Select an engine for the text-to-speech feature.
- **Language:** Change the spoken language of the text-to-speech feature.
- **Speech rate:** Adjust the speed for the text-to-speech feature.
- **Pitch:** Adjust the pitch of the text-to-speech feature.
- **PLAY:** Play a short demonstration of your speech settings.
- **RESET:** Reset the speech speed and pitch.

## Direction lock

Create a directional combination to unlock the screen.

- 1 Launch the **Settings** app, tap **Accessibility** → **Direction lock**, and then tap the switch to activate it.
- 2 Drag your finger up, down, left, or right six to eight times, and then tap **CONTINUE**.
- 3 Draw the direction combination again to verify it and tap **CONFIRM**.

## Direct access

Set to open accessibility menus quickly.

Launch the **Settings** app, tap **Accessibility** → **Direct access**, and then tap the switch to activate it. Then, select an accessibility menu to open when you simultaneously press the Power key and the Volume Up key.

You can access the following accessibility menus:

- Accessibility
- Voice Assistant
- Universal switch
- Magnifier window
- Negative colours
- Colour adjustment
- Interaction control

## Accessibility shortcut

Set to start a shortcut service quickly.

Launch the **Settings** app, tap **Accessibility** → **Accessibility shortcut**, and then tap the switch to activate it. Then, tap **Shortcut service** and select a shortcut service to start when you simultaneously press and hold the Volume Up key and the Volume Down key for three seconds.

You can access the following shortcut service:

- Samsung universal switch
- Voice Assistant



## Notification reminder

Set the device to alert you to notifications that you have not checked at the interval.

Launch the **Settings** app, tap **Accessibility** → **Notification reminder**, and then tap the switch to activate it.

To set the device to vibrate when you have unchecked notifications, tap the **Vibrate** switch to activate it.

To set an interval between alerts, tap **Reminder interval**.

To set apps to alert you to notifications, select apps under **SHOW NOTIFICATIONS FROM**.

## Answering or ending calls

Change the method for answering or ending calls.

Launch the **Settings** app and tap **Accessibility** → **Answering and ending calls**.

Select the desired method.

## Using single tap mode

When an alarm sounds or a call comes in, tap the button to stop the alarm, or answer or reject the call instead of dragging the button.

Launch the **Settings** app and tap **Accessibility**, and then tap the **Single tap mode** switch to activate it.

## Managing accessibility settings

### Saving accessibility settings in a file

Export the current accessibility settings in a file.

Launch the **Settings** app and tap **Accessibility** → **Accessibility settings backup** → **Import/export** → **Export to My Files**.

### Importing an accessibility settings file

Import an accessibility settings file and update the current settings.

Launch the **Settings** app and tap **Accessibility** → **Accessibility settings backup** → **Import/export** → **Import from My Files**. Select a file to import and tap **DONE**. The accessibility settings will be updated according to the imported file.

### Sharing accessibility settings files

Share accessibility settings files with others via email, Wi-Fi Direct, Bluetooth, and more.

Launch the **Settings** app and tap **Accessibility** → **Accessibility settings backup** → **Share**. Then, select the accessibility files and tap **DONE**. Select a sharing method and follow the on-screen instructions to share the files.

## Troubleshooting

Before contacting a Samsung Service Centre, please attempt the following solutions. Some situations may not apply to your device.

### When you turn on your device or while you are using the device, it prompts you to enter one of the following codes:

- **Password:** When the device lock feature is enabled, you must enter the password you set for the device.
- **PIN:** When using the device for the first time or when the PIN requirement is enabled, you must enter the PIN supplied with the SIM or USIM card. You can disable this feature by using the Lock SIM card menu.
- **PUK:** Your SIM or USIM card is blocked, usually as a result of entering your PIN incorrectly several times. You must enter the PUK supplied by your service provider.
- **PIN2:** When you access a menu requiring the PIN2, you must enter the PIN2 supplied with the SIM or USIM card. For more information, contact your service provider.

### Your device displays network or service error messages

- When you are in areas with weak signals or poor reception, you may lose reception. Move to another area and try again. While moving, error messages may appear repeatedly.
- You cannot access some options without a subscription. For more information, contact your service provider.

### Your device does not turn on

When the battery is completely discharged, your device will not turn on. Fully charge the battery before turning on the device.

## The touchscreen responds slowly or improperly

- If you attach a screen protector or optional accessories to the touchscreen, the touchscreen may not function properly.
- If you are wearing gloves, if your hands are not clean while touching the touchscreen, or if you tap the screen with sharp objects or your fingertips, the touchscreen may malfunction.
- The touchscreen may malfunction in humid conditions or when exposed to water.
- Restart your device to clear any temporary software bugs.
- Ensure that your device software is updated to the latest version.
- If the touchscreen is scratched or damaged, visit a Samsung Service Centre.

## Your device freezes or encounters a fatal error

Try the following solutions. If the problem is still not resolved, contact a Samsung Service Centre.

### Restarting the device

If your device freezes or hangs, you may need to close apps or turn off the device and turn it on again.

### Forcing restart

If your device is frozen and unresponsive, press and hold the Power key and the Volume Down key simultaneously for more than 7 seconds to restart it.

### Resetting the device

If the methods above do not solve your problem, perform a factory data reset.

Launch the **Settings** app and tap **General management** → **Reset** → **Factory data reset** → **RESET** → **DELETE ALL**. Before performing the factory data reset, remember to make backup copies of all important data stored in the device.

## **Calls are not connected**

- Ensure that you have accessed the right cellular network.
- Ensure that you have not set call barring for the phone number you are dialing.
- Ensure that you have not set call barring for the incoming phone number.

## **Others cannot hear you speaking on a call**

- Ensure that you are not covering the built-in microphone.
- Ensure that the microphone is close to your mouth.
- If using an earphone, ensure that it is properly connected.

## **Sound echoes during a call**

Adjust the volume by pressing the Volume key or move to another area.

## **A cellular network or the Internet is often disconnected or audio quality is poor**

- Ensure that you are not blocking the device's internal antenna.
- When you are in areas with weak signals or poor reception, you may lose reception. You may have connectivity problems due to issues with the service provider's base station. Move to another area and try again.
- When using the device while moving, wireless network services may be disabled due to issues with the service provider's network.

## **The battery icon is empty**

Your battery is low. Charge the battery.

## **The battery does not charge properly (For Samsung-approved chargers)**

- Ensure that the charger is connected properly.
- Visit a Samsung Service Centre and have the battery replaced.

## **The battery depletes faster than when first purchased**

- When you expose the device or the battery to very cold or very hot temperatures, the useful charge may be reduced.
- Battery consumption will increase when you use certain features or apps, such as GPS, games, or the Internet.
- The battery is consumable and the useful charge will get shorter over time.

## **Error messages appear when launching the camera**

Your device must have sufficient available memory and battery power to operate the camera app. If you receive error messages when launching the camera, try the following:

- Charge the battery.
- Free some memory by transferring files to a computer or deleting files from your device.
- Restart the device. If you are still having trouble with the camera app after trying these tips, contact a Samsung Service Centre.

## **Photo quality is poorer than the preview**

- The quality of your photos may vary, depending on the surroundings and the photography techniques you use.
- If you take photos in dark areas, at night, or indoors, image noise may occur or images may be out of focus.

## Error messages appear when opening multimedia files

If you receive error messages or multimedia files do not play when you open them on your device, try the following:

- Free some memory by transferring files to a computer or deleting files from your device.
- Ensure that the music file is not Digital Rights Management (DRM)-protected. If the file is DRM-protected, ensure that you have the appropriate licence or key to play the file.
- Ensure that the file formats are supported by the device. If a file format is not supported, such as DivX or AC3, install an app that supports it. To confirm the file formats that your device supports, visit [www.samsung.com](http://www.samsung.com).
- Your device supports photos and videos captured with the device. Photos and videos captured by other devices may not work properly.
- Your device supports multimedia files that are authorized by your network service provider or providers of additional services. Some content circulated on the Internet, such as ringtones, videos, or wallpapers, may not work properly.

## Bluetooth is not working well

If another Bluetooth device is not located or there are connection problems or performance malfunctions, try the following:

- Ensure that the device you wish to connect with is ready to be scanned or connected to.
- Ensure that your device and the other Bluetooth device are within the maximum Bluetooth range (10 m).
- On your device, launch the **Settings** app, tap **Connections**, and then tap the **Bluetooth** switch to re-activate it.
- On your device, launch the **Settings** app, tap **General management** → **Reset** → **Reset network settings** → **RESET SETTINGS** to reset network settings. You may lose registered information when performing the reset.

If the tips above do not solve the problem, contact a Samsung Service Centre.

## A connection is not established when you connect the device to a computer

- Ensure that the USB cable you are using is compatible with your device.
- Ensure that you have the proper driver installed and updated on your computer.
- If you are a Windows XP user, ensure that you have Windows XP Service Pack 3 or higher installed on your computer.

## Your device cannot find your current location

GPS signals may be obstructed in some locations, such as indoors. Set the device to use Wi-Fi or a mobile network to find your current location in these situations.

## Data stored in the device has been lost

Always make backup copies of all important data stored in the device. Otherwise, you cannot restore data if it is corrupted or lost. Samsung is not responsible for the loss of data stored in the device.

## A small gap appears around the outside of the device case

- This gap is a necessary manufacturing feature and some minor rocking or vibration of parts may occur.
- Over time, friction between parts may cause this gap to expand slightly.

## There is not enough space in the device's storage

Delete unnecessary data, such as cache, using the Smart manager or manually delete unused apps or files to free up storage space.

## The Apps button does not appear on the Home screen

Without using the Apps button, you can open the Apps screen by swiping upwards or downwards on the Home screen. To display the Apps button at the bottom of the Home screen, launch the **Settings** app and tap **Display** → **Home screen** → **Apps button** → **Show Apps button** → **APPLY**.



## The Home button does not appear

The navigation bar containing the Home button may disappear while using certain apps or features. To view the navigation bar, drag upwards from the bottom of the screen.

## Bixby Voice does not respond

- Restart your device to clear any temporary software bugs.
- Ensure that your device software is updated to the latest version.
- If you are still having trouble with Bixby Voice after trying these tips, contact a Samsung Service Centre.

## The screen brightness adjustment bar does not appear on the notification panel

Open the notification panel by dragging the status bar downwards, and then drag the notification panel downwards. Tap  next to the brightness adjustment bar and tap the **Show control on top** switch to activate it.

## Samsung Cloud does not work

- Ensure that you are connected to a network properly.
- During a Samsung Cloud service check, you cannot use Samsung Cloud. Try again later.

## The device does not recognize my irises from the locked screen

- Ensure that nothing obstructing the iris recognition camera and LED and try again.
- If light conditions are very different from when you registered your irises, the device may not recognize your irises. Move to another location and try again.
- Ensure that the device is not moving or tilted too much.

## Replace the battery

- **To replace the battery, contact an authorized service centre.**
- For your safety, you **must not attempt to remove** the battery. If the battery is not properly removed, it may lead to damage to the battery and device, cause personal injury, and/or result in the device being unsafe.
- Samsung does not accept liability for any damage or loss (whether in contract or tort, including negligence) which may arise from failure to precisely follow these warnings and instructions, other than death or personal injury caused by Samsung's negligence.

# Health and Safety

Please read this important safety information before you use the device. It contains general safety information for devices and may include content that does not apply to your device. Follow the warning and caution information to prevent injury to yourself or others and to prevent damage to your device.



The term 'device' refers to the product and its battery, charger, the items supplied with the product, and any Samsung-approved accessories used with the product.



**Warning: Failure to comply with safety warnings and regulations can cause serious injury or death.**

## **Do not use damaged power cords or plugs, or loose electrical sockets**

Unsecured connections can cause electric shock or fire.

## **Do not touch the device, power cords, plugs, or the electric socket with wet hands or other wet body parts**

Doing so may cause electric shock.

## **Do not pull the power cord excessively when disconnecting it**

Doing so may cause electric shock or fire.

## **Do not bend or damage the power cord**

Doing so may cause electric shock or fire.

## **Do not use the device with wet hands while the device is charging**

Doing so may cause electric shock.

## **Do not directly connect together the charger's positive and negative terminals**

Doing so may cause fire or serious injury.

## **Do not use your device outdoor during a thunderstorm**

Doing so may result in electric shock or device malfunction.

## **Use manufacturer-approved batteries, chargers, accessories, and supplies**

- Using generic batteries or chargers may shorten the life of your device or cause the device to malfunction. They may also cause a fire or cause the battery to explode.
- Use only a Samsung-approved battery and charger specifically designed for your device. An incompatible battery or charger can cause serious injuries or damage to your device.
- Samsung cannot be responsible for the user's safety when using accessories or supplies that are not approved by Samsung.

### **Do not carry your device in your back pockets or on your waist**

- The device may be damaged, explode, or result in a fire if too much pressure is applied to it.
- You may be injured if you are bumped or fall.

### **Do not drop or cause an impact to the charger or the device**

#### **Handle and dispose of the device and charger with care**

- Never dispose of the battery or device in a fire. Never place the battery or device on or in heating devices, such as microwave ovens, stoves, or radiators. The device may explode when overheated. Follow all local regulations when disposing of used battery or device.
- Never crush or puncture the device.
- Avoid exposing the device to high external pressure, which can lead to an internal short circuit and overheating.

#### **Protect the device, battery and charger from damage**

- Avoid exposing your device and battery to very cold or very hot temperatures.
- Extreme temperatures can damage the device and reduce the charging capacity and life of your device and battery.
- Do not directly connect together the battery's positive and negative terminals and prevent them from coming into contact with metal objects. Doing so may cause the battery to malfunction.
- Never use a damaged charger or battery.

### **Do not store your device near or in heaters, microwaves, hot cooking equipment, or high pressure containers**

- The battery may leak.
- Your device may overheat and cause a fire.

### **Do not use or store your device in areas with high concentrations of dust or airborne materials**

Dust or foreign materials can cause your device to malfunction and may result in fire or electric shock.

### **Prevent the multipurpose jack and the small end of the charger from contact with conductive materials, such as liquids, dust, metal powders, and pencil leads. Do not touch the multipurpose jack with sharp tools or cause an impact to the multipurpose jack**

Conductive materials may cause a short circuit or corrosion of the terminals, which may result in an explosion or fire.

**When using the wireless charger, do not place foreign materials, such as metal objects, magnets, and magnetic stripe cards, between the device and the wireless charger**

The device may not charge properly or may overheat.

**Do not bite or suck the device or the battery**

- Doing so may damage the device or result in an explosion or fire.
- Children or animals can choke on small parts.
- If children use the device, make sure that they use the device properly.

**Do not insert the device or supplied accessories into the eyes, ears, or mouth**

Doing so may cause suffocation or serious injuries.

**Do not handle a damaged or leaking Lithium Ion (Li-Ion) battery**

For safe disposal of your Li-Ion battery, contact your nearest authorized service centre.



**Caution: Failure to comply with safety cautions and regulations can cause injury or property damage**

**Do not use your device near other electronic devices**

- Most electronic devices use radio frequency signals. Your device may interfere with other electronic devices.
- Using an LTE data connection may cause interference with other devices, such as audio equipment and telephones.

**Do not use your device in a hospital, on an aircraft, or in automotive equipment that can be interfered with by radio frequency**

- Avoid using your device within a 15 cm range of a pacemaker, if possible, as your device can interfere with the pacemaker.
- To minimize possible interference with a pacemaker, use your device only on the side of your body that is opposite the pacemaker.
- If you use medical equipment, contact the equipment manufacturer before using your device to determine whether or not the equipment will be affected by radio frequencies emitted by the device.
- On an aircraft, using electronic devices can interfere with the aircraft's electronic navigational instruments. Make sure the device is turned off during takeoff and landing. After takeoff, you can use the device in flight mode if allowed by aircraft personnel.
- Electronic devices in your car may malfunction due to radio interference from your device. Contact the manufacturer for more information.

### **Do not expose the device to heavy smoke or fumes**

- Doing so may damage the outside of the device or cause it to malfunction.

### **If you use a hearing aid, contact the manufacturer for information about radio interference**

The radio frequency emitted by your device may interfere with some hearing aids. Before using your device, contact the manufacturer to determine whether or not your hearing aid will be affected by radio frequencies emitted by the device.

### **Do not use your device near devices or apparatuses that emit radio frequencies, such as sound systems or radio towers**

Radio frequencies may cause your device to malfunction.

### **Turn off the device in potentially explosive environments**

- Turn off your device in potentially explosive environments instead of removing the battery.
- Always comply with regulations, instructions and signs in potentially explosive environments.
- Do not use your device at refuelling points (gas stations), near fuels or chemicals, or in blasting areas.
- Do not store or carry flammable liquids, gases, or explosive materials in the same compartment as the device, its parts, or accessories.

### **If you notice strange smells or sounds coming from your device or the battery, or if you see smoke or liquids leaking from the device or battery, stop using the device immediately and take it to a Samsung Service Centre**

Failure to do so may result in fire or explosion.

### **Comply with all safety warnings and regulations regarding mobile device usage while operating a vehicle**

While driving, safely operating the vehicle is your first responsibility. Never use your mobile device while driving, if it is prohibited by law. For your safety and the safety of others, use your common sense and remember the following tips:

- Get to know your device and its convenience features, such as speed dial and redial. These features help you reduce the time needed to place or receive calls on your mobile device.
- Position your device within easy reach. Make sure you can access your wireless device without taking your eyes off the road. If you receive an incoming call at an inconvenient time, let your voicemail answer it for you.
- Suspend use in heavy traffic or hazardous weather conditions. Rain, sleet, snow, ice, and heavy traffic can be hazardous.

- Do not take notes or look up phone numbers. Jotting down a “to do” list or flipping through your address book takes attention away from your primary responsibility of driving safely.
- Dial sensibly and assess the traffic. Place calls when you are not moving or before pulling into traffic. Try to plan calls when your car will be stationary.
- Do not engage in stressful or emotional conversations that may be distracting. Make the person you are talking to aware that you are driving and suspend conversations that could potentially divert your attention from the road.

## Care for and use your mobile device properly

### Keep your device dry

- Humidity and liquids may damage the parts or electronic circuits in your device.
- Do not turn on your device if it is wet. If your device is already on, turn it off and remove the battery immediately (if the device will not turn off or you cannot remove the battery, leave it as-is). Then, dry the device with a towel and take it to a service centre.
- This device has internal liquid indicators fitted. Water damage to your device may void the manufacturer’s warranty.

### Store your device only on flat surfaces

- If your device falls, it may be damaged.

**The device can be used in locations with an ambient temperature of 0°C to 35°C. You can store the device at an ambient temperature of -20°C to 50°C. Using or storing the device outside of the recommended temperature ranges may damage the device or reduce the battery’s lifespan**

- Do not store your device in very hot areas such as inside a car in the summertime. Doing so may cause the screen to malfunction, result in damage to the device, or cause the battery to explode.
- Do not expose your device to direct sunlight for extended periods of time (on the dashboard of a car, for example).
- For a device with a removable battery, the battery can be stored separately in locations with an ambient temperature of 0 °C to 45 °C.

### Do not store your device with metal objects, such as coins, keys, and necklaces

- Your device may be scratched or may malfunction.
- If the battery terminals come into contact with metal objects, this may cause a fire.

### **Do not store your device near magnetic fields**

- Your device may malfunction or the battery may discharge from exposure to magnetic fields.
- Magnetic stripe cards, including credit cards, phone cards, passbooks, and boarding passes, may be damaged by magnetic fields.

### **Prolonged exposure of your skin to an overheated device may cause low temperature burn symptoms, such as red spots and pigmentation**

### **Do not use your device with the back cover removed**

The battery may fall out of the device, which may result in damage or malfunction.

### **If your device has a camera flash or light, do not use it close to the eyes of people or pets**

Using a flash close to the eyes may cause temporary loss of vision or damage to the eyes.

### **Use caution when exposed to flashing lights**

- While using your device, leave some lights on in the room and do not hold the screen too close to your eyes.
- Seizures or blackouts can occur when you are exposed to flashing lights while watching videos or playing Flash-based games for extended periods. If you feel any discomfort, stop using the device immediately.
- If anyone related to you has experienced seizures or blackouts while using a similar device, consult a physician before using the device.
- If you feel discomfort, such as a muscle spasm, or disoriented, stop using the device immediately and consult a physician.
- To prevent eye strain, take frequent breaks while using the device.

### **Reduce the risk of repetitive motion injuries**

When you repetitively perform actions, such as pressing keys, drawing characters on a touch screen with your fingers, or playing games, you may experience occasional discomfort in your hands, neck, shoulders, or other parts of your body. When using your device for extended periods, hold the device with a relaxed grip, press the keys lightly, and take frequent breaks. If you continue to have discomfort during or after such use, stop using the device and consult a physician.



### **Protect your hearing and ears when using a headset**



- Excessive exposure to loud sounds can cause hearing damage.
- Exposure to loud sounds while walking may distract your attention and cause an accident.

- Always turn the volume down before plugging the earphones into an audio source and use only the minimum volume setting necessary to hear your conversation or music.
- In dry environments, static electricity can build up in the headset. Avoid using headsets in dry environments or touch a metal object to discharge static electricity before connecting a headset to the device.
- Do not use a headset while driving or riding. Doing so may distract your attention and cause an accident, or may be illegal, depending on your region.

### **Use caution when using the device while walking or moving**

- Always be aware of your surroundings to avoid injury to yourself or others.
- Make sure the headset cable does not become entangled in your arms or on nearby objects.

### **Do not paint or put stickers on your device**

- Paint and stickers can clog moving parts and prevent proper operation.
- If you are allergic to paint or metal parts of the device, you may experience itching, eczema, or swelling of the skin. When this happens, stop using the device and consult your physician.

### **Do not use the device if the screen is cracked or broken**

- Broken glass or acrylic could cause injury to your hands and face. Take the device to a Samsung Service Centre to have it repaired.

### **Install mobile devices and equipment with caution**

- Ensure that any mobile devices or related equipment installed in your vehicle are securely mounted.
- Avoid placing your device and accessories near or in an airbag deployment area. Improperly installed wireless equipment can cause serious injury when airbags inflate rapidly.

### **Do not drop your device or cause impacts to your device**

- Your device may be damaged or may malfunction.
- If bent or deformed, your device may be damaged or parts may malfunction.

### **Ensure maximum battery and charger life**

- Batteries may malfunction if they are not used for extended periods.
- Over time, unused device will discharge and must be recharged before use.
- Disconnect the charger from power sources when not in use.
- Use the battery only for its intended purpose.
- Follow all instructions in this manual to ensure the longest lifespan of your device and battery. Damage or poor performance caused by failure to follow warnings and instructions can void your manufacturer's warranty.
- Your device may wear out over time. Some parts and repairs are covered by the warranty within the validity period, but damages or deterioration caused by using unapproved accessories are not.

### **When using the device, mind the following**

- Hold the device upright, as you would with a traditional phone.
- Speak directly into the microphone.

### **Do not disassemble, modify, or repair your device**

- Any changes or modifications to your device can void your manufacturer's warranty. If your device needs servicing, take your device to a Samsung Service Centre.
- Do not disassemble or puncture the battery, as this can cause explosion or fire.
- Turn off the device before removing the battery. If you remove the battery with the device turned on, it may cause the device to malfunction.

### **When cleaning your device, mind the following**

- Wipe your device or charger with a towel or an eraser.
- Clean the battery terminals with a cotton ball or a towel.
- Do not use chemicals or detergents. Doing so may discolour or corrode the outside the device or may result in electric shock or fire.

### **Do not use the device for anything other than its intended use**

- Your device may malfunction.

### **Avoid disturbing others when using the device in public**

### **Allow only qualified personnel to service your device**

- Allowing unqualified personnel to service your device may result in damage to your device and will void your manufacturer's warranty.

### **Handle SIM cards, memory cards and cables with care**

- When inserting a card or connecting a cable to your device, make sure that the card is inserted or the cable is connected to the proper side.
- Do not remove a card while the device is transferring or accessing information, as this could result in loss of data and/or damage to the card or device.
- Protect cards from strong shocks, static electricity, and electrical noise from other devices.
- Do not touch gold-coloured contacts or terminals with your fingers or metal objects. If dirty, wipe the card with a soft cloth.
- Inserting a card or connecting a cable by force or improperly may result in damage to the multipurpose jack or other parts of the device.

### **Ensure access to emergency services**

Emergency calls from your device may not be possible in some areas or circumstances. Before travelling in remote or undeveloped areas, plan an alternative method of contacting emergency services personnel.

### **Protect your personal data and prevent leakage or misuse of sensitive information**

- While using your device, be sure to back up important data. Samsung is not responsible for the loss of any data.
- When disposing of your device, back up all data and then reset your device to prevent misuse of your personal information.
- Carefully read the permissions screen when downloading applications. Be particularly cautious with applications that have access to many functions or to a significant amount of your personal information.
- Check your accounts regularly for unapproved or suspicious use. If you find any sign of misuse of your personal information, contact your service provider to delete or change your account information.
- In the event your device is lost or stolen, change the passwords on your accounts to protect your personal information.
- Avoid using applications from unknown sources and lock your device with a pattern, password, or PIN.

### **Do not distribute copyright-protected material**

Do not distribute copyright-protected material without the permission of the content owners. Doing this may violate copyright laws. The manufacturer is not liable for any legal issues caused by the user's illegal use of copyrighted material.

## Malware and viruses

**To protect your device from malware and viruses, follow these usage tips. Failure to do so may result in damages or loss of data that may not be covered by the warranty service**

- Do not download unknown applications.
- Do not visit untrusted websites.
- Delete suspicious messages or email from unknown senders.
- Set a password and change it regularly.
- Deactivate wireless features, such as Bluetooth, when not in use.
- If the device behaves abnormally, run an antivirus program to check for infection.
- Run an antivirus program on your device before you launch newly-downloaded applications and files.
- Install antivirus programs on your computer and run them regularly to check for infection.
- Do not edit registry settings or modify the device's operating system.

## Acknowledging Special Precautions and Industry Canada Notice

### Cautions

Any changes or modifications to your device not expressly approved in this document could void your warranty for this equipment, and void your authority to operate this equipment. Only use approved batteries, antennas, and chargers. The use of any unauthorized accessories may be dangerous and void the phone warranty if they cause damage or a defect to the device.

Although your device is quite sturdy, it is a complex piece of equipment and can be broken. Avoid dropping, hitting, bending, or sitting on it.

### Information to User

This equipment has been tested and found to comply with the limits of a Class B digital device. These limits are designed to provide reasonable protection against harmful interference in a residential installation. This equipment generates, uses, and can radiate radio frequency energy and, if not installed and used in accordance with the instructions, may cause harmful interference to radio communications. However, there is no guarantee that interference will not occur in a particular installation; if this equipment does cause harmful interference to radio or television reception, which can be determined by turning the equipment off and on, the user is encouraged to try to correct the interference by one or more of the following measures:

- Reorient/relocate the receiving antenna.
- Increase the separation between the equipment and receiver.
- Connect the equipment into an outlet on a circuit different from that to which the receiver is connected.

Consult the dealer or an experienced radio/TV technician for help.



**Warning:** At very high volumes, prolonged listening to a headset can damage your hearing.

### Specific Absorption Rates (SAR) for Wireless Devices

The SAR is a value that corresponds to the relative amount of RF energy absorbed by the user of a wireless device.

The SAR value of a device is the result of an extensive testing, measuring and calculation process. It does not represent how much RF the device emits. All devices are tested at their highest value in strict laboratory settings. But when in operation, the SAR of a device can be substantially less than the level reported to Industry Canada. This is because of a variety of factors including its proximity to a base station antenna, design and other factors. What is important to remember is that each device meets strict federal guidelines. Variations in SARs do not represent a variation in safety.

All devices must meet the federal standard, which incorporates a substantial margin of safety. As stated above, variations in SAR values between different model devices do not mean variations in safety. SAR values at or below the federal standard of 1.6 W/kg are considered safe for use by the public.

This device has been tested and meets RF exposure guidelines when used with an accessory that contains no metal and that positions the mobile device 0mm from the body.

## Correct disposal of this product

(Waste Electrical & Electronic Equipment)



This marking on the product, accessories or literature indicates that the product and its electronic accessories (e.g., charger, headset, USB cable) should not be disposed of with other household waste.

To prevent possible harm to the environment or human health from uncontrolled waste disposal, please separate these items from other types of waste and recycle them responsibly to promote the sustainable reuse of material resources.

Household users should contact either the retailer where they purchased this product, or their local government office, for details of where and how they can take these items for environmentally safe recycling.

Business users should contact their supplier and check the terms and conditions of the purchase contract. This product and its electronic accessories should not be mixed with other commercial wastes for disposal.

This product is RoHS compliant.

## Correct disposal of batteries in this product



This marking on the battery, manual or packaging indicates that the batteries in this product should not be disposed of with other household waste at the end of their working life. Where marked, the chemical symbols Hg, Cd or Pb indicate that the battery contains mercury, cadmium or lead above the reference levels in EC Directive 2006/66.

## Disclaimer

Some content and services accessible through this device belong to third parties and are protected by copyright, patent, trademark and/or other intellectual property laws. Such content and services are provided solely for your personal non-commercial use. You may not use any content or services in a manner that has not been authorized by the content owner or service provider. Without limiting the foregoing, unless expressly authorized by the applicable content owner or service provider, you may not modify, copy, republish, upload, post, transmit, translate, sell, create derivative works, exploit, or distribute in any manner or medium any content or services displayed through this device.

“THIRD PARTY CONTENT AND SERVICES ARE PROVIDED “AS IS.” SAMSUNG DOES NOT WARRANT CONTENT OR SERVICES SO PROVIDED, EITHER EXPRESSLY OR IMPLIED, FOR ANY PURPOSE. SAMSUNG EXPRESSLY DISCLAIMS ANY IMPLIED WARRANTIES, INCLUDING BUT NOT LIMITED TO, WARRANTIES OF MERCHANTABILITY OR FITNESS FOR A PARTICULAR PURPOSE. SAMSUNG DOES NOT GUARANTEE THE ACCURACY, VALIDITY, TIMELINESS, LEGALITY, OR COMPLETENESS OF ANY CONTENT OR SERVICE MADE AVAILABLE THROUGH THIS DEVICE AND UNDER NO CIRCUMSTANCES, INCLUDING NEGLIGENCE, SHALL SAMSUNG BE LIABLE, WHETHER IN CONTRACT OR TORT, FOR ANY DIRECT, INDIRECT, INCIDENTAL, SPECIAL OR CONSEQUENTIAL DAMAGES, ATTORNEY FEES, EXPENSES, OR ANY OTHER DAMAGES ARISING OUT OF, OR IN CONNECTION WITH, ANY INFORMATION CONTAINED IN, OR AS A RESULT OF THE USE OF ANY CONTENT OR SERVICE BY YOU OR ANY THIRD PARTY, EVEN IF ADVISED OF THE POSSIBILITY OF SUCH DAMAGES.”

Third party services may be terminated or interrupted at any time, and Samsung makes no representation or warranty that any content or service will remain available for any period of time. Content and services are transmitted by third parties by means of networks and transmission facilities over which Samsung has no control. Without limiting the generality of this disclaimer, Samsung expressly disclaims any responsibility or liability for any interruption or suspension of any content or service made available through this device.

Samsung is neither responsible nor liable for customer service related to the content and services. Any question or request for service relating to the content or services should be made directly to the respective content and service providers.

## Copyright

Copyright © 2018 Samsung Electronics

This manual is protected under international copyright laws.

No part of this manual may be reproduced, distributed, translated, or transmitted in any form or by any means, electronic or mechanical, including photocopying, recording, or storing in any information storage and retrieval system, without the prior written permission of Samsung Electronics.

## Trademarks

- SAMSUNG and the SAMSUNG logo are registered trademarks of Samsung Electronics.
- Bluetooth® is a registered trademark of Bluetooth SIG, Inc. worldwide.
- Wi-Fi®, Wi-Fi Protected Setup™, Wi-Fi Direct™, Wi-Fi CERTIFIED™, and the Wi-Fi logo are registered trademarks of the Wi-Fi Alliance.
- All other trademarks and copyrights are the property of their respective owners.

## IC Notice

This Class B digital apparatus complies with Canadian ICES-003.

This device complies with Industry Canada licence-exempt RSS standard(s). Operation is subject to the following two conditions:

- (1) this device may not cause interference, and
- (2) this device must accept any interference, including interference that may cause undesired operation of the device.



## About HEVC Advance



THIS PRODUCT IS SOLD WITH A LIMITED LICENCE AND IS AUTHORISED TO BE USED ONLY IN CONNECTION WITH HEVC CONTENT THAT MEETS EACH OF THE THREE FOLLOWING QUALIFICATIONS: (1) HEVC CONTENT ONLY FOR PERSONAL USE; (2) HEVC CONTENT THAT IS NOT OFFERED FOR SALE; AND (3) HEVC CONTENT THAT IS CREATED BY THE OWNER OF THE PRODUCT.

THIS PRODUCT MAY NOT BE USED IN CONNECTION WITH HEVC ENCODED CONTENT CREATED BY A THIRD PARTY, WHICH THE USER HAS ORDERED OR PURCHASED FROM A THIRD PARTY, UNLESS THE USER IS SEPARATELY GRANTED RIGHTS TO USE THE PRODUCT WITH SUCH CONTENT BY A LICENSED SELLER OF THE CONTENT.

YOUR USE OF THIS PRODUCT IN CONNECTION WITH HEVC ENCODED CONTENT IS DEEMED ACCEPTANCE OF THE LIMITED AUTHORITY TO USE AS NOTED ABOVE.