

SAMSUNG

Technical White Paper

5G Standalone Architecture

January 2021

Contents

03 Introduction

04 NR Architecture Overview

- Option 2
- Option 3/3a/3x
- Option 4/4a
- Option 5
- Option 7/7a/7x
- Non-Standalone vs. Standalone

09 Key Drivers for 5G SA

12 Migration Path for 5G SA

- Direct Migration Path to Option 2
- Migration Path to Option 2 via Option 3 Family

16 Considerations in NR SA

- Coverage
- Latency
- Mobility
- Bands Utilization
- Voice Service

20 Summary

21 Abbreviations

References

Introduction

LTE mobile technology has changed our lifestyles significantly with high data rates and low latency. With the diverse services and requirements demanded from today's mobile industry, however, LTE by itself is not capable of handling the necessary throughput, latency and reliability. Compared to LTE, 5G enables much higher data rates and ultra-low latency by using wide spectrum of high-frequency bands and advanced networking technology. 5G targets twenty times higher data rates and much shorter latency than LTE. As a result, more reliable transmissions and higher UE connection density will be possible in the 5G network. Key comparisons between 4G and 5G have been drawn in Table 1 [1].

Table 1. Comparison between 4G and 5G

Item	4G	5G
Peak Data Rate	1 Gbps (DL)	20 Gbps (DL)
User Experienced Data Rate	10 Mbps	100 Mbps
Spectrum Efficiency	-	X3
Areal Traffic Capacity	0.1 Mbps/m ²	10 Mbps/m ²
Latency	10ms	1ms
Connection Density	100,000/km ²	1,000,000/km ²
Network Energy Efficiency	-	X100
Mobility	350km/h	500km/h
Bandwidth	Up to 20 MHz	Up to 1 GHz

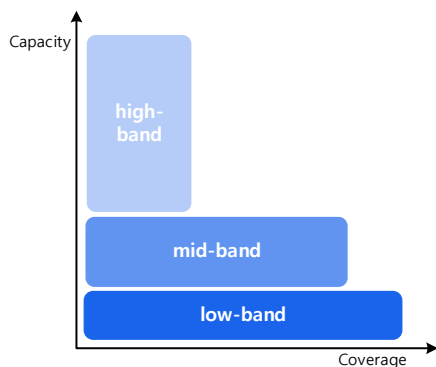

Figure 1. Illustrated comparison per 5G bands

A wide range of frequency bands are required for 5G to provide high speed data transmissions. The 5G frequency bands can be divided into three categories: low-band, mid-band and high-band. The low-band uses a frequency range below 1GHz, similar to that of LTE. The mid-band ranges from 1GHz to 6GHz and has balanced service coverage and capacity compared to the low-band and the high-band. The high-band, such as mmWave, sits above 24GHz and provides the fastest speeds and tremendous capacity, as a result of its large bandwidth, but is smaller in coverage range due to its low penetration rate. Therefore, an operator needs to weigh in the pros and cons of the different spectrums to determine whether they are feasible options for initial

use cases, as well as to decide whether or not they are scalable for future use cases. Figure 1 shows the differences among 5G frequency bands in terms of capacity and coverage. Due to the coverage characteristics of the 5G frequency bands, high-bands are suitable for dense urban areas, mid-bands for metropolitan areas, and low-bands for national wide coverage.

The 3rd Generation Partnership Project (3GPP) introduces two primary architecture options for 5G deployment from LTE: Non-Standalone (NSA) and Standalone (SA). NSA enables rapid 5G service deployment with minimum investment by leveraging the existing LTE infrastructures. SA consists of a single Radio Access Technology (RAT), meaning it is possible to provide full 5G enhancements designed to work only in the 5G New Radio (NR) SA

architecture. As mentioned above, an operator needs to carefully decide which 5G deployment option best suits its network deployment scenario by considering a number of factors. For example, NSA may be the most sensible option for a fast 5G deployment from a cost perspective since it leverages legacy LTE networks. However, the NSA deployment option is limited in that it can't fully support all the 5G-specific services, such as, URLLC and network slicing. In this document, NR architecture options, 5G key services, 5G SA migration path and operating considerations in NR SA will be presented.

NR Architecture Overview

The 3GPP introduces six architecture options for NR deployment as shown in Figure 2. These architecture options are divided into two deployment scenarios: SA and NSA [2][3]. The SA provides NR service by using a single RAT, whereas the NSA enables NR deployment by utilizing the existing LTE systems. Options 1, 2 and 5 belong to the SA category, while options 3, 4 and 7 belong to the NSA category. However, since option 1 is a legacy LTE system, in which an E-UTRAN NodeB (eNB) is connected to an Evolved Packet Core (EPC), also referred to as 4G Core Network (CN), it is not considered when dealing with NR deployment scenarios.

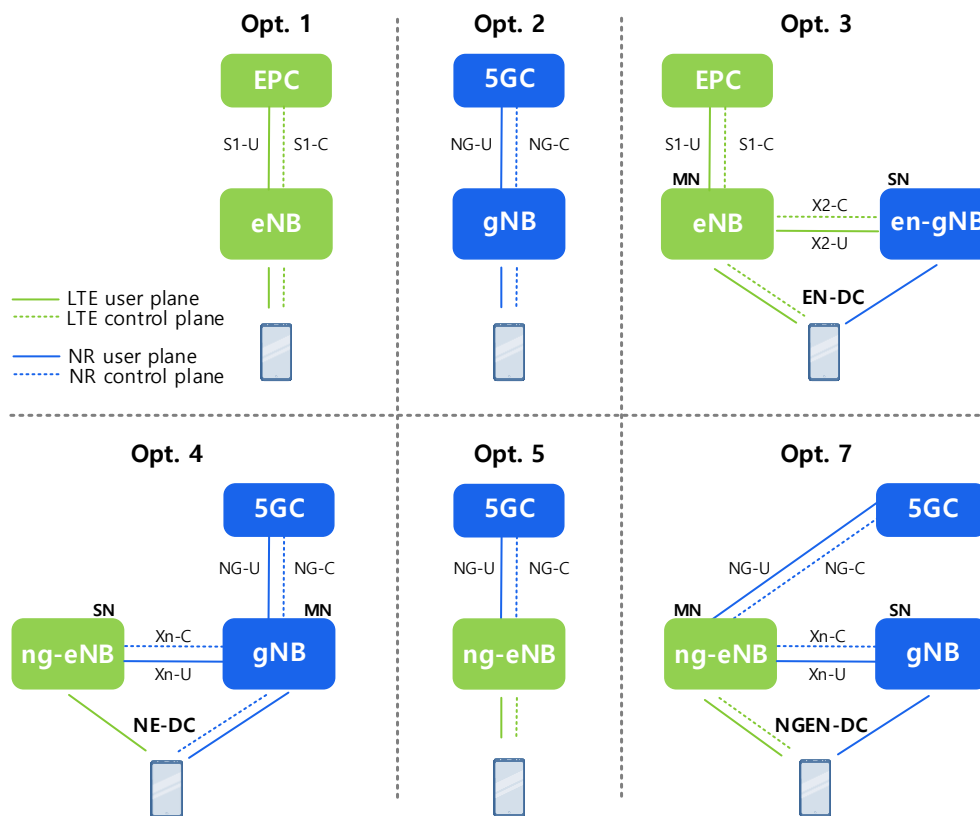

Figure 2. NR deployment architecture options

In a NSA deployment, Multi-Radio Dual Connectivity (MR-DC) provides a UE with simultaneous connectivity to two different generation RAN nodes (i.e., next generation NodeB (gNB) and eNB). Of the two nodes, one acts as a Master Node (MN) and the other as a Secondary Node (SN). The MN is connected with the SN and 4G/5G CN. The SN can be connected with the Core depending on options [4].

Generally, MR-DC is categorized as shown in Table 2. In MR-DC, a UE connects with the MN/CN and can communicate with SN via MN for control plane. For user plane, a UE can connect with either MN/SN directly or SN via MN.

Table 2. MR-DC Lists

Lists	Associated CN	Associated Option	Note
E-UTRA-NR Dual Connectivity (EN-DC)	EPC	Option 3	eNB acts as an MN and en-gNB acts as a SN.
NR-E-UTRA Dual Connectivity (NE-DC)	5GC	Option 4	gNB acts as an MN and ng-eNB acts as a SN
NG-RAN E-UTRA-NR Dual Connectivity (NGEN-DC)	5GC	Option 7	ng-eNB acts as an MN and gNB acts as a SN
NR-NR Dual Connectivity (NR-DC)	5GC	Option 2	One gNB acts as an MN and another gNB acts as a SN

NOTE en-gNB represents a gNB that can connect with EPC and eNB. An ng-eNB stands for enhanced LTE (eLTE) eNB which can communicate with 5G Core (5GC) and gNB. en-gNB provides NR control/user plane protocol terminations towards the UE, while ng-eNB provides LTE control/user plane protocol terminations towards the UE.

Option 2

Option 2 is a NR SA option, in which the gNB is connected to the 5GC. This NR SA option is suitable for greenfield 5G operators. The gNB can communicate with UEs without the help of a legacy network. This option introduces both 5GC and RAN from day one and is the ultimate goal of 5G migration paths. It can fully support new 5G services including enhanced Mobile Broadband (eMBB), massive Machine-Type Communication (mMTC), Ultra-Reliable Low-Latency Communication (URLLC) and network slicing. Since dual connectivity is not a mandatory requirement for this option, it requires less workload when upgrading an eNB for interworking with the NR system. This option will be discussed in more detail in the migration chapter that follows.

Option 3/3a/3x

Option 3 family is a NSA option, in which the en-gNB is deployed in the LTE network and thus does not need a 5GC. In this option 5G services are deployed using the EN-DC with the LTE as MN and the NR as SN. This option may be preferred by operators that already have a nationwide LTE network, because it allows quick 5G migration with minimum LTE upgrade without 5GC. However, it also has a disadvantage, in that, the scope of 5G services is restricted to RAN capability due to its dependency on the legacy EPC. For example, URLLC or network slicing is not supported. Therefore, operators choosing option 3 has a long term task of migrating to option 2, if they are to provide the full extent of 5G services. This option is further divided into three types based on the traffic split method as shown in Figure 3.

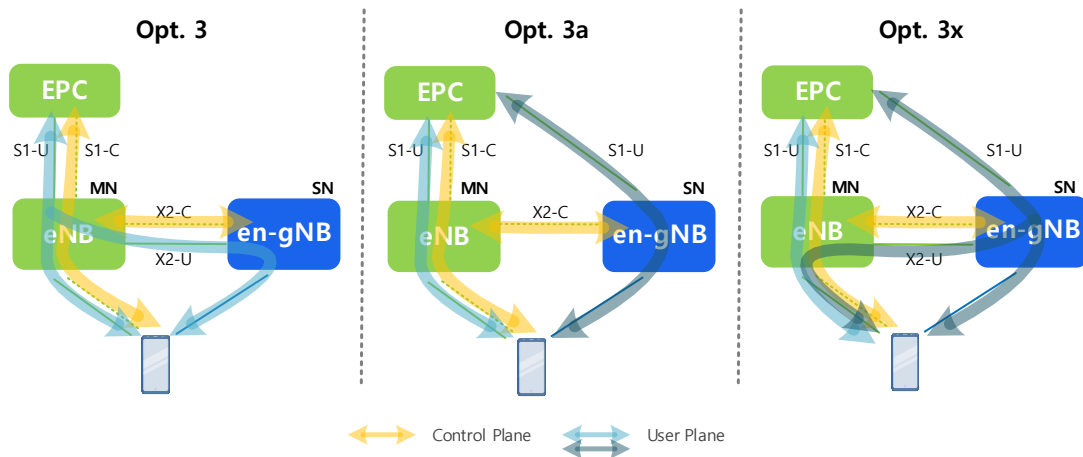

Figure 3. NR architecture variants of option 3

From a control plane perspective, the eNB is connected to the EPC, and the en-gNB operates with the eNB via X2 interface for all option 3 variants. For user plane, traffic split is done at the eNB for option 3, while traffic split in option 3a is done at EPC. In option 3, the eNB can transmit user plane traffic from the EPC toward the UE directly over the LTE air interface or forward a part of the traffic to the en-gNB via X2 interface. In option 3a, the EPC can transmit/receive user traffic to/from both the eNB and the en-gNB. Option 3x is a combination of option 3 and 3a where the EPC can deliver user traffic to either eNB or en-gNB, which forwards them to the UE over the air. The en-gNB can steer the received user plane traffic toward the UE directly over the NR air interface or indirectly through the eNB via X2 interface.

Option 4/4a

Option 4 family is a NSA option, in which the gNB is connected to the 5GC, and both gNB and ng-eNB are connected with each other. In this option, the eNB needs to be upgraded to ng-eNB in order to interwork with the 5GC or gNB. This option supports NE-DC to aggregate NR and LTE traffic. The option is further divided into two types depending on the traffic split method used, as shown in Figure 4.

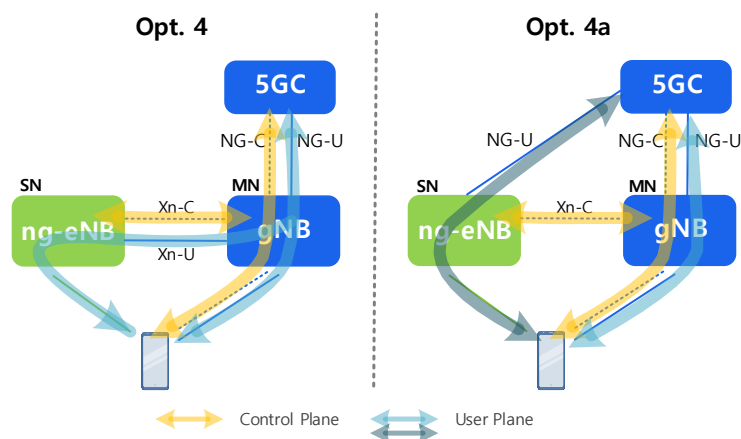

Figure 4. NR architecture variants of option 4

From a control plane perspective, the gNB is connected to the 5GC, and the gNB operates with the ng-eNB via Xn interface for option 4 and 4a. For user plane, traffic split is done at the gNB in option 4, while it is done at the 5GC in option 4a. In option 4, the gNB can transmit user plane traffic from the 5GC toward the UE directly over the NR air interface or forward indirectly a part of the traffic through the ng-eNB via Xn interface. In option 4a, the 5GC can transmit/receive user traffic to/from both the gNB and ng-eNB.

Option 5

Option 5 is a SA option, in which the ng-eNB is connected to the 5GC through the NG interface, but without dual connectivity with NR systems. In this option, the EPC is replaced by the 5GC in the existing LTE network. The eNB needs to be upgraded in order to interwork with the 5GC. The ng-eNB can provide some 5GC-enabling benefits such as network slicing. However, this option isn't highly beneficial since it does not utilize the benefits of 5G NR air interface such as mmWave, multiple numerologies, and flexible frame structure.

Option 7/7a/7x

Option 7 family is a NSA option, in which the eNB is connected to the 5GC, and both the eNB and gNB are connected with each other. In this option, the eNB needs to be upgraded to ng-eNB in order to interwork with 5GC or gNB. It supports dual connectivity called NGEN-DC to aggregate NR and LTE traffic. This option is divided into three types based on the traffic split method as shown in Figure 5.

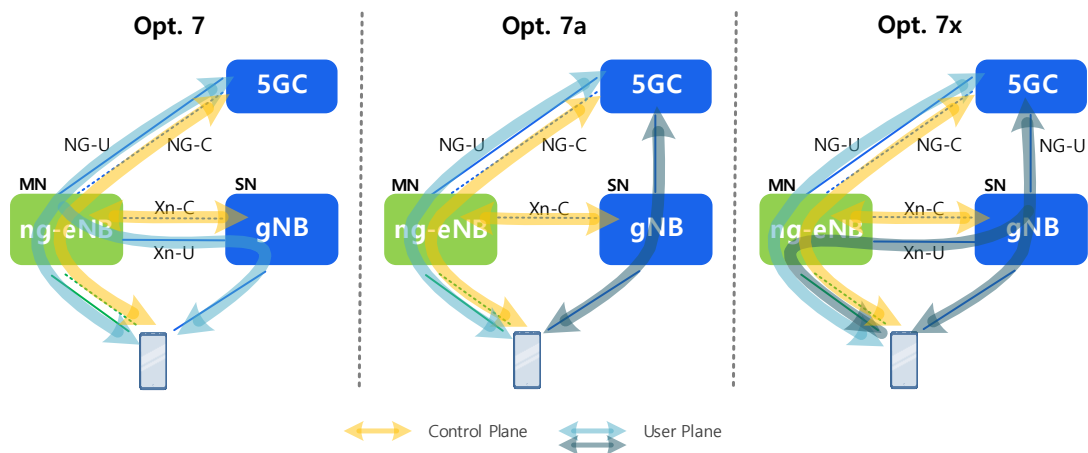

Figure 5. NR architecture variants of option 7

From a control plane perspective, the master ng-eNB is connected to the 5GC, and the ng-eNB operates with the gNB via Xn interface for all option 7 variants. For user plane, however, traffic split is done at the ng-eNB in option 7, while it is done at the 5GC in option 7a. In option 7, the ng-eNB can transmit user plane traffic from the 5GC toward the UE directly over the LTE air interface or forward a part of the traffic through the gNB via Xn interface. In option 7a, the 5GC can transmit/receive user traffic to/from both ng-eNB and gNB. Option 7x is a combination of option 7 and 7a where the 5GC can deliver user traffic to either ng-eNB or gNB; then the ng-eNB forwards them to the UE over the LTE air interface. The gNB can transmit the received data from the 5GC toward the UE directly over the NR air interface or forward a part of the traffic through the ng-eNB via Xn interface.

Non-Standalone vs. Standalone

Table 3 below summarizes the major differences between the different NR deployment options, as specified in the previous section. Option 1 as referred to as legacy LTE and option 5 which is least likely to be adopted are excluded. Options 3, 4 and 7 relying on the existing LTE network require an alignment with LTE network, so sub-6GHz bands are recommended for NR deployment. In addition, they need to interwork with LTE tightly through dual connectivity such as EN-DC/NE-DC or NGEN-DC. However, NR deployment using option 2 is free to configure the 5G network. For example, mid-band can be used for wide NR coverage and mmWave can be utilized for hot-spot in urban area. Option 3 can provide limited 5G service like eMBB due to EPC, but options 2, 4 and 7 can provide full 5G-specific services. Although option 4 and option 7 belong to NSA category according to the 3GPP, it is reasonable to regard them as SA because they can provide 5G-specific services due to the architecture that contains NR RAN as a MN and 5GC.

Table 3. Comparison between deployment options

Items	NSA		SA
	Option 3	Option 4, Option 7	Option 2
Associated DC	EN-DC	Opt.4: NE-DC Opt.7: NGEN-DC	NR-DC (Not Mandatory)
Required CN	EPC	5GC	5GC
Required RAN	eNB, en-gNB	ng-eNB, gNB	gNB
Feasibility of 5G spectrum	Sub-6GHz, mmWave	Sub-6GHz, mmWave	Sub-6GHz (Desirable), mmWave
Required Time for 5G Deployment	Short	Long	Long
LTE Upgrade	Major upgrade	Major upgrade	Minor upgrade
Alignment with LTE	Preferred	Preferred	Not Required
Interworking with LTE	Tight interworking between LTE and NR	Tight interworking between LTE and NR	CN-level interworking (Inter-RAT mobility)
Control Anchor	LTE	Opt.4: NR Opt.7: LTE	NR
Supporting 5G Service	eMBB	Support at gNB side (eMBB, URLLC, mMTC, Network Slicing)	Full support (eMBB, URLLC, mMTC, Network Slicing)
Supporting Voice Service	VoLTE	VoNR (VoLTE by fallback is possible when VoNR is unavailable)	VoNR (VoLTE by fallback is possible when VoNR is unavailable)
Multi-vendor interoperability	Not Easy	Not Easy	Easy

Key Drivers for 5G SA

As compared to 4G which primarily focused on delivering communication service such as voice or mobile broadband, 5G provides not only more advanced technologies that can enable much higher data rates and lower latency, but also new use cases to allow new business opportunities. The International Telecommunication Union (ITU) classifies three key use cases as part of the 5G vision: eMBB, URLLC, and mMTC. Using these basic use cases, an operator is able to build other use cases as it sees fit to address new emerging market needs. eMBB focuses on high data rate services such as HD video or Virtual Reality (VR)/ Augmented Reality (AR), while URLLC focuses on latency sensitive or mission critical services such as autonomous driving or remote surgery. mMTC focuses on services with high density of connectivity such as smart city or massive IoTs. The expansion of communication services brought forth by 5G allows industries without previous mobile connectivity to participate in the communications ecosystem. However, NR SA and 5GC serve as key enablers in bringing these services to life. New services such as URLLC and network slicing are only possible with the presence of 5GC. Further, these individual services complement each other and therefore work in synergy to provide better 5G-specific services. NR SA migration, with 5G RAN and 5GC, is the key to offering innovative 5G services and quickly address the emerging market.

URLLC

URLLC allows a network to be optimized for processing large amounts of data with extremely low latency and high reliability. This requires sub-millimeter latency with 10^{-5} block error rates. URLLC uses mini-slot scheduling, the smallest scheduling unit which supports short transmission duration with the reduced processing time, and UL grant free transmission to achieve low latency requirements. By using the UL grant free transmission, a UE does not need to wait for the gNB to assign resources. Network slicing and Multi-access Edge Computing (MEC) can leverage URLLC service effectively. Network slicing enables isolated slices for URLLC and can assign dedicated resources only for URLLC. Equally as important, MEC can dramatically eliminate network delays by hosting services at the edge in close proximity to the customers. URLLC is particularly effective for latency sensitive services or mission critical IoTs, and allows several new business use cases such as remote surgery, autonomous driving, real time traffic information service and remote robot management in factory environments. Figure 6 shows the areas in which URLLC can be applied and the requirements for each area.

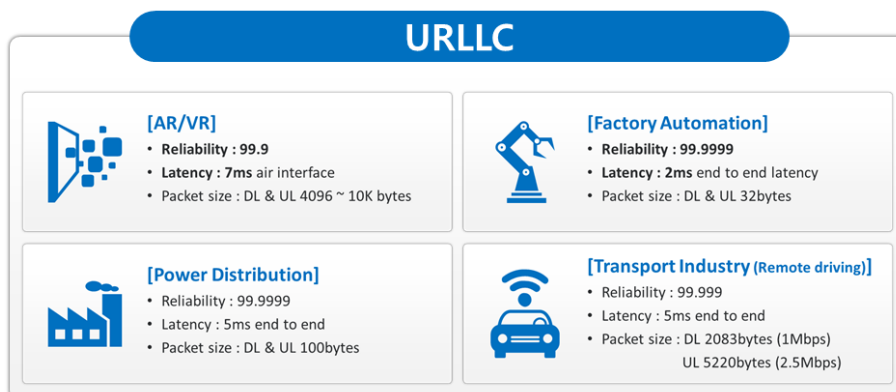

Figure 6. Examples utilizing URLLC

Network Slicing

Network slicing is the concept of creating logically divided multiple end-to-end virtual networks on a common physical infrastructure without constructing a separate network. In 4G, network slicing was provided in the limited form of isolating a service within a common infrastructure such as Multi Operator Core Network (MOCN) or Dedicated Core Network (DECOR). In 5G, however, network slicing will allow operators to create virtual data pipelines as well as control/management functions for each type of service, thereby assuring the QoS for each service. Figure 7 shows how virtual networks are separated and managed for each service type such as eMBB, mMTC and URLLC within a common infrastructure. Network slicing is able to guarantee the quality of data transmission for time-sensitive services or mission-critical services such as connected cars by allocating isolated and dedicated resources. Ultimately, an operator will be able to leverage this technology to enable new revenue streams [5].

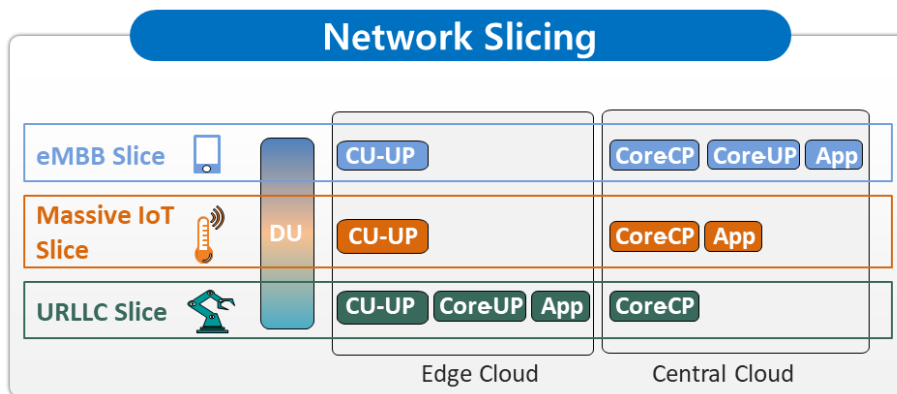

Figure 7. Examples utilizing network slicing

IIoT/V2X

Machine-Type Communication (MTC) services such as enhanced MTC (eMTC) and narrow-band Internet of Things (NB-IoT) have already been introduced and served in legacy LTE network. In 5G, the MTC technology has been enhanced to mMTC, which is capable of serving extremely high connection densities (up to 1 million devices per km²) that is 10 times greater than the maximum number served by a LTE network. In addition, ultra-reliable mMTC is able to provide ultra-reliable low-latency communication for network services with extremely challenging requirements on availability, latency and reliability, such as Industrial Internet of Things (IIoT) and Vehicle-to-everything (V2X). IIoT is utilized for controlling applications of automated systems in various areas such as smart factory, gas/water metering, city light management, transport traffic management, and asset tracking/monitoring. These applications require the network that they run on to be ultra-reliable, highly available, and very low end-to-end latency. V2X enables various solutions for Vehicle to Vehicle (V2V), Vehicle to Infrastructure (V2I), and Vehicle to Pedestrian (V2P) communication. V2X has several use cases such as vehicle platooning (coordinated driving with collision avoidance), semi/fully-autonomous driving, remote driving, and real-time information exchange through sensors. Also, V2X enables in-car entertainment services such as movies, TV streaming, and voice conference call. V2X services demand high data rates, very low latency, and high reliability simultaneously, and these requirements can be met by using native 5G services such as eMBB and URLLC. For example, vehicle platooning and autonomous/remote driving require very low latency and high reliability, for which URLLC service is suitable, while the use of cameras and accident monitoring requires high data rate which can be supported by eMBB. If further guarantees on latency and reliability are required, eMBB/URLLC services can be combined with other 5G services such as MEC and network slicing.

5GC

5GC holds a key role in realizing the full potential of 5G services. Without 5GC, fully-fledged NR services cannot be obtained. 5G NSA deployment leaning on legacy LTE network and EPC allows for a quick launch of 5G services, but also hinders the realization of 5G's full potential. In 5GC, a cloud native design is introduced to enable flexible scaling and upgrades. The fundamental concept of a cloud native 5GC is defined as 'stateless micro-services deployed in a container-based architecture'. A Network Function (NF) is comprised of small service units called NF services (i.e., micro-services), and NFs store their state information in a central database called Unstructured Data Storage Function (UDSF), which turns the network function itself, stateless. Stateless NFs can be scaled easily and specific NFs can be isolated in case of failures, which in turn makes an uninterrupted service possible. Each micro-service runs in a container and is independently scalable and re-usable. These design characteristics enable the flexible launch of new services, faster time-to-market, and offers enhanced scalability. As a result, the 5GC functions can be quickly created, deployed, and scaled, using automated lifecycle management.

With the introduction of 5GC and NR SA, enhanced features such as RRC inactive state, end-to-end network slicing can be applied. RRC inactive state allows a network to suspend and resume to/from inactive state, so as to allow a UE to return to a connected state as soon as possible from an inactive state. Accordingly, this leads to significant reduction in RRC signaling, and therefore latency and battery consumption are reduced as well.

Samsung 5GC is designed for cloud native based on micro-services, containers and stateless architecture. In addition, Samsung provides a common core solution that combines network functions from EPC and 5GC which support LTE, NR (NSA and SA), and non-3GPP accesses, including Wi-Fi and fixed broadband. A unified authentication process supports multi-RAT access technologies [6]. The Samsung 5G Common Core solution reduces the cost of maintaining EPC and enables the expedient introduction of 5G services in full scale without impacts on legacy services.

Migration Path for 5G SA

Among the several NR deployment options, this paper will focus on two most practical migration paths toward option 2, the ultimate 5G goal: (a) a direct migration to option 2; and (b) an indirect migration to option 2 via option 3.

Direct migration to Option 2

This migration path introduces 5G CN and RAN from day one. It builds an independent 5G network and does not rely on the existing LTE network in providing a 5G service. Figure 8 shows the migration path based on option 2. It allows a simple management with its relatively simple architecture, and ensures minimum impact on the existing LTE network as operators own and manage LTE and NR networks independently. This architecture calls for standard based interworking between the EPC and 5GC for inter-RAT mobility. Therefore, it allows new 5G vendors to come into play and prevents vendor lock-ins. Moreover, there is no substantial limitation when deploying 5G features and services such as URLLC or network slicing as both 5G CN and RAN are available from day one.

For robust service continuity, inter-RAT mobility is supported using the N26 interface between the EPC and 5GC. A SA UE can manage LTE and NR connection independently, and can connect to either the LTE or NR network at any given time, as illustrated in the following. A UE located in a 5G coverage area connects to the 5G network. Once the UE moves out of the 5G coverage and into a 4G coverage area, the gNB decides whether to perform inter-RAT mobility depending on the measurement report from the UE. Once the gNB receives the measurement report, it decides to perform either a handover or redirection via interface between EPC and 5GC. Consequently, the UE connects to the LTE network and releases its connection from the 5G network, while maintaining its IP address for service continuity. Dual connectivity is not mandatory for this scenario.

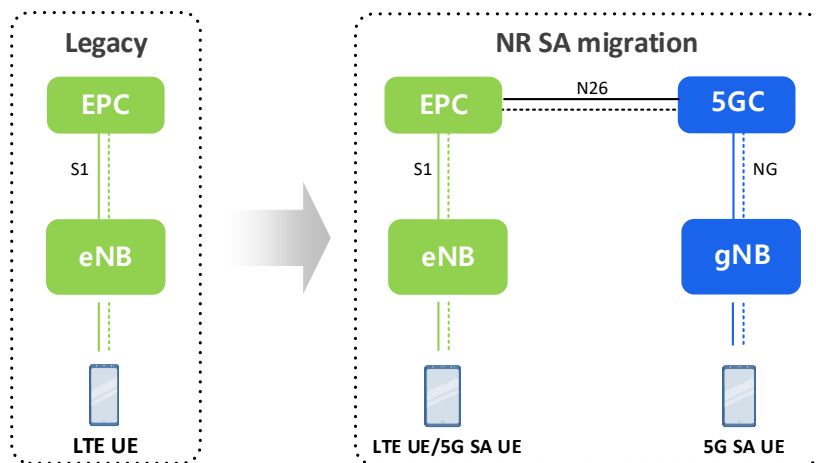

Figure 8. Migration architecture based on option 2.

As the number of LTE-only UE reduces and the number of NR UE increases, an operator needs to consider additional NR migration on its remaining LTE band, as shown in Figure 9. In such scenarios, spectrum re-farming is the conventional migration method, but needs years of time and efforts. Dynamic Spectrum Sharing (DSS) can serve as an alternative migration option that allows use of existing LTE spectrum by 5G network. DSS enables the sharing of a single legacy LTE carrier for both LTE and NR. With DSS, resources are dynamically coordinated between the LTE and NR according to the real time change in LTE and NR traffic loads [7].

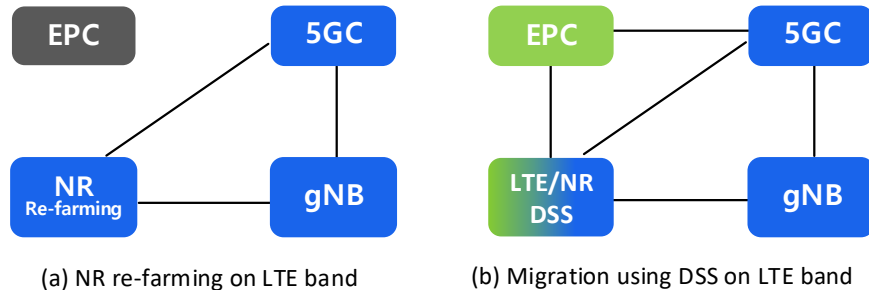

Figure 9. Migration method on remaining LTE band

A disadvantage of this migration option is that a large initial investment is needed to setup new 5G networks consisting of 5GC and gNB, without the help of existing LTE/EPC networks. Moreover, the fact that the EPC needs to be maintained until the 4G network is completely replaced by the 5G network adds to an operator's OPEX burden.

If an operator deploys NR using the mid-band with option 2, cell coverage may be decreased compared to that of the NSA option since there is no LTE support. In such case, to enhance UL coverage, Massive MIMO, DFT-S-OFDM, High Power UE (HPUE) are defined by the 3GPP. With SA, an operator can provide the full extent of 5G services from day one, prevailing over any other operators who might choose a different option. Therefore, such an operator increases its chances of monetizing from new 5G business opportunities. In addition, smooth and fast migration to a full 5G SA network is possible as interim NSA UEs are not required.

Migration Path to Option 2 via Option 3 Family

5G deployment using EN-DC (option 3) can be an ideal choice for the operator who has an existing LTE network with EPC. This option allows for a quick 5G launch by adding en-gNB to an existing LTE network with a low initial investment. However, this option cannot provide 5G-specific services that include URLLC or network slicing until the network incorporates a 5GC. Therefore, in the long run, an operator who chooses option 3 as its migration path needs to eventually move to option 2, in order to provide users with the full extent of 5G services. Moreover, with option 3, additional time is needed until all interim NSA UEs have been moved out. Figure 10 illustrates 5G migration paths utilizing NSA options such as options 3x and 4.

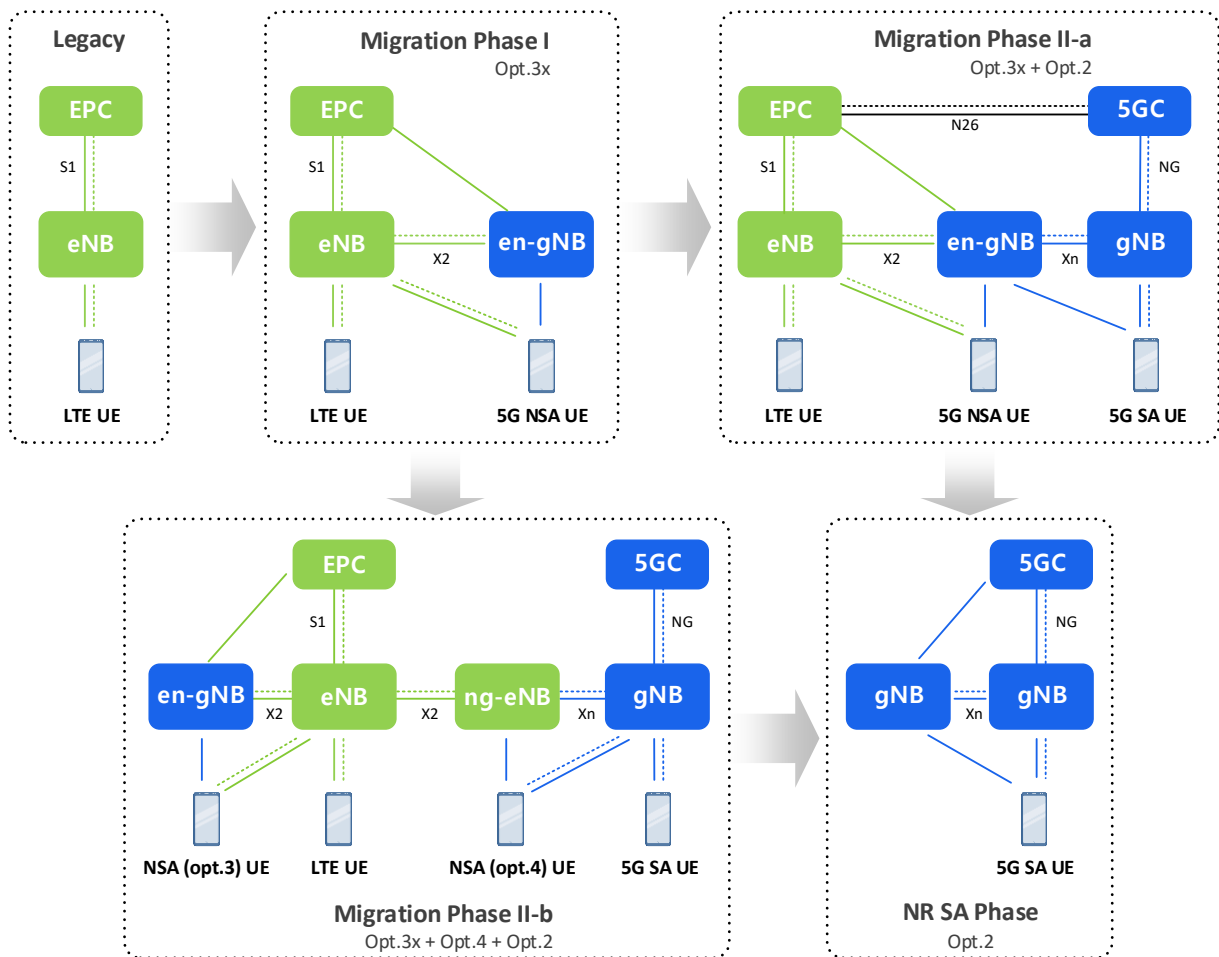

Figure 10. Example of migration roadmap to 5G SA via NSA options

Migration Phase I

Option 3x is applied on the legacy LTE network. An en-gNB is added to the legacy LTE network and connected with the EPC. 5G NSA UE with EN-DC capability can connect to the LTE network and aggregate both LTE and NR using EN-DC in order to increase data throughput, while LTE UE connects only to the legacy LTE network. LTE eNB is utilized for improving service robustness in regions with poor NR coverage. In EN-DC, Master Cell Group (MCG)-bearers use LTE radio resources, and Secondary Cell Group (SCG)-bearers use NR radio resources. Split bearers use both LTE and NR resources. QoS mechanism is based on 4G as 5GC is not introduced yet. This option requires tight interworking between eNB and en-gNB via X2 interface. Therefore, both legacy eNB and EPC need to be upgraded to support interworking with en-gNB. When an operator considers the introduction of a 5GC, the operator is able to consider both option 2 and option 4.

Migration Phase II-a

During this phase, SA option 2 with 5GC is added to NSA option 3. Here, legacy LTE UE, NSA opt.3 UE and SA opt.2 UE co-exist. An operator may skip Migration Phase II-a and move to the NR SA Phase, if the interim NSA UE no longer exists. The LTE UE connects to the LTE network only, and the NSA UE connects to the LTE network with traffic aggregation of both LTE and NR using EN-DC. The SA UE can connect to either LTE or NR depending on its coverage. All 5G services can be provided to the SA UE from this phase onward.

Migration Phase II-b

In this phase, SA option 2 and NSA option 4, with 5GC, are added to NSA option 3, and Legacy LTE UE, NSA opt.3/opt.4 UE and SA opt.2 UE can co-exist. NSA opt.3 UE or SA UE operates in the same way as described in Migration Phase II-a. The NSA opt.4 UE connects to the gNB with traffic aggregation of both NR and LTE using NE-DC. The SA UE may not gain the large amount of data, compared to LTE Carrier Aggregation (CA) or EN-DC utilizing multiple carriers. With the introduction of options 2 and 4, along with the 5GC, 5G services can be provided.

NR SA Phase

This is the last phase of moving to 5G SA. Since many number of NSA UEs still remain it may take an operator longer to enter this stage. If two NR frequencies are available, traffic aggregation using two NR frequencies, known as NR-DC, can be provided to achieve higher throughput. To utilize the remaining LTE band, an operator may consider migrating the remaining LTE band to NR using re-farming or DSS. This would be done under the assumption that the number of LTE UEs is insignificant.

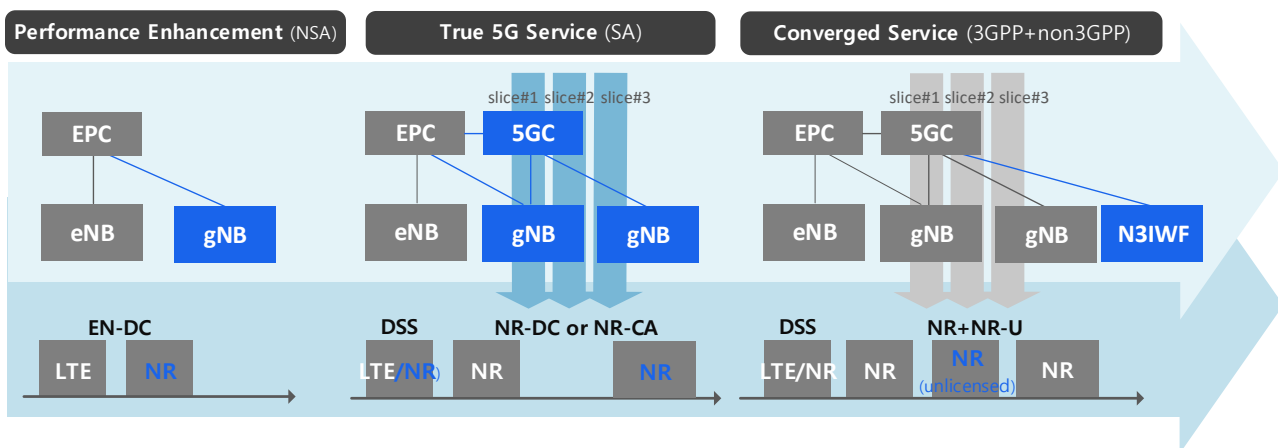

Figure 11. Migration roadmap from 4G to 5G

Samsung provides the full scope of 5G solutions ranging from NSA for early 5G deployment to SA solution with both licensed and unlicensed spectrums. In addition, non-3GPP items such as Wi-Fi can be covered using Samsung's solutions. Figure 11 shows Samsung's comprehensive 5G roadmap.

In early stages, Samsung provides fast 5G deployment solution using the NSA option. With this, an operator can provide not only wider coverage by utilizing LTE at the lower band, but also enhanced UE throughput by using NR spectrum. As NR demand increases over time, NSA and SA will co-exist with option 3, option 4 and option 2. Coverage enhancement can be achieved by DSS at lower LTE bands or FDD/TDD NR CA, and UE throughput is enhanced by NR-DC or NR-CA. As a direct result of introducing 5GC to the network, 5G SA services such as URLLC, networking slicing are available from this point. In the end, Samsung will provide a converged 5G service for both 3GPP and non-3GPP mobile service, as well as wireless and wireline service. Accordingly, operators will have new revenue stream opportunities by leveraging the full-fledged 5G service, and end-customers will come to experience the 5G service in full.

Considerations in NR SA

Coverage

Coverage is the geographic area in which communication between a base station and a user equipment is possible. Generally, coverage is measured by Maximum Allowable Path Loss (MAPL) which denotes the upper limit of the path loss that the signal can persist with sufficient quality. It is affected by various factors such as transmit power, antenna gain, frequency band, system characteristics, and receiver performance. Among these, frequency bands can cause a major impact on coverage. For example, the higher carrier frequency becomes, the smaller the coverage area becomes due to the higher radio signal attenuation. Therefore, NR systems using mid-band or high-band provide a smaller coverage than that provided by the LTE system using low-band or mid-band in terms of frequency band. During a call setup process, most channels are used in both NSA and SA architecture, hence, it is expected that there is no degradation on call setup coverage performance for SA migration. From an uplink data transmission perspective, in SA architecture, uplink data can only be transferred through the uplink data channel of NR, therefore the uplink data coverage of SA is bound by the NR Physical Uplink Share Channel (PUSCH) coverage. On the other hand, in NSA architecture, uplink data transmission can be carried by NR or dynamically selected RAT between NR and LTE depending on the service provider's choice. The latter in NSA is called uplink path switching. Without uplink path switching, the NSA and SA are equal in terms of coverage. However, the coverage of the SA would be smaller than that of the NSA if uplink path switching has been applied to the NSA. However, coverage enhancement techniques such as carrier aggregation or cross carrier with low-band can serve to compensate the coverage degradation mentioned above. FR2 SA is much smaller than FR1 SA and LTE, so FR1-FR2 DC using FR1 as an anchor can be utilized to provide bigger signaling coverage.

Latency

The latency of the idle-to-active procedure in NSA is larger than in SA. The different latencies come from signaling differences of the architecture. In NSA, to transition from idle to active state, the UE first performs an idle-to-active procedure in LTE, which serves as the MN. Once connected, the UE connects to the NR through the SN addition procedure. However, a SA UE connects to NR without additional signaling procedures during idle-to-active procedure. If the RRC inactive state feature is applied to NR SA network, the latency can be reduced greatly by foregoing additional signaling with 5GC, and performing the inactive-to-active procedure instead. The latency can be considered also in terms of handover interruption time. Handover in NSA needs both LTE handover and NR cell change with/without SN change, while handover in SA only requires NR cell change. As a result, the NSA handover interruption time roughly doubles the SA.

Mobility

In the case of a direct SA option 2 migration from legacy LTE, mobility scenarios are less complicated with NR deployed at a nation-wide scale. A SA UE can manage LTE and NR connection independently, as it can connect to either the LTE or NR network at any given time. When the UE connects to 5G network, it can experience 5G services, so long as it stays within the NR coverage. If two frequencies, FR1 and FR2, are available in the 5G network, the UE can aggregate user traffic in both paths by utilizing NR-DC. When the UE moves out of 5G

coverage and into a 4G coverage, as shown in Figure 12, the gNB performs a handover or redirection so that the UE may connect to the LTE network, releasing its 5G connection while maintaining its previously assigned IP address for service continuity. If the UE moves in reverse direction, a handover or redirection from the LTE to the NR is performed as well for seamless service.

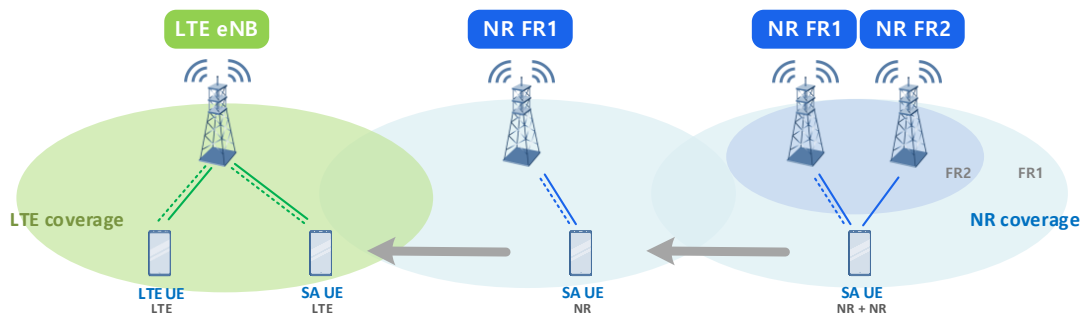

Figure 12. Mobility support with SA option 2

In NSA, however, NR will generally use mid-band or high-band carriers deployed because low-band is mainly occupied by LTE. Mid-band has a larger propagation and penetration loss compared to low-band, so this physical condition limits mid-band's NR coverage. This coverage issue can be compensated by advanced features such as Massive MIMO, Beamforming and Dual Connectivity. In NSA utilizing legacy LTE infrastructure, NR coverage holes between NR cells may exist, as shown in Figure 13, due to the difference in coverage of the low and mid-band. When a NSA UE is in NR coverage, the UE connects to the LTE network as a control plane anchor and aggregates user plane traffic for both LTE and NR using EN-DC. As the NR coverage using mid-band is smaller than that of the LTE, the UE releases its connection on the NR network and initiates an attach procedure to the LTE when moving out of NR coverage to LTE only coverage. When the UE moves to another cell which is covered by both LTE and NR, the UE enables EN-DC, if possible.

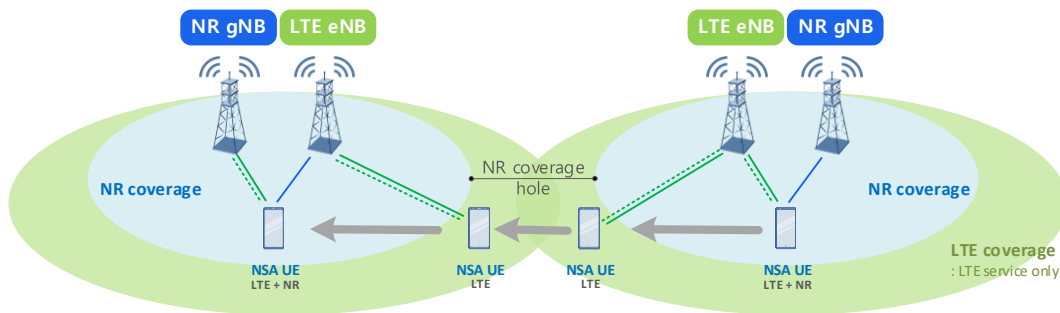

Figure 13. Mobility support with NSA option 3

Figure 14-(a) shows a scenario in which multiple gNBs are deployed within a single eNB's coverage. If a NSA UE is in coverage of gNB #1, the UE connects to LTE network and aggregates user plane traffic for both LTE and NR using EN-DC. When the UE moves to the coverage of gNB #2 while remaining within the coverage of the same eNB, the UE performs a SN change and aggregates user plane traffic from both eNB and gNB #2. Figure 14-(b) shows an example where a gNB is deployed between two eNBs. Given this situation, when the UE moves to eNB #2 from eNB #1 while staying within the coverage of the same gNB, the secondary node, the UE performs an inter-eNB handover without a SN change.

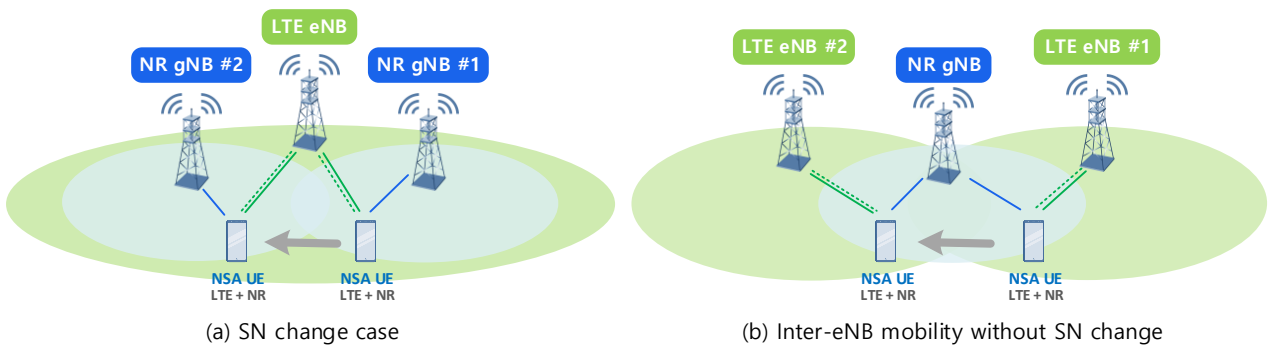

Figure 14. Mobility support with other NR deployed case based on NSA option 3

Bands Utilization

To overcome the short coverage and to enhance performance utilizing frequencies, DC or CA can be applied. Figure 15 below illustrates how this can be done on high frequency bands such as 28GHz.

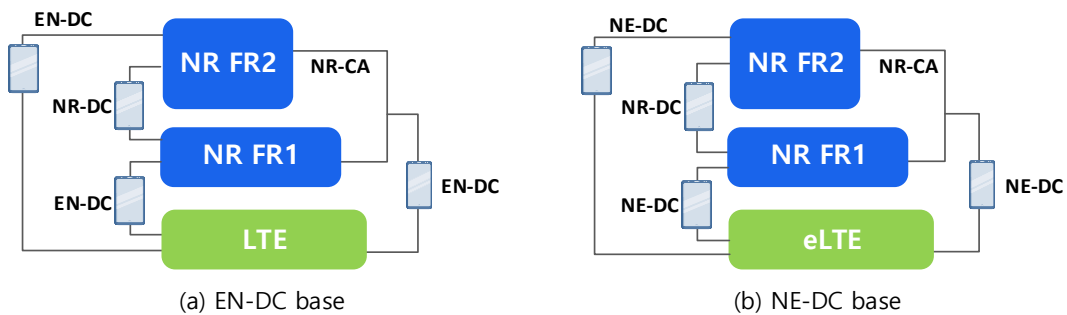

Figure 15. High-band utilization based on NSA option

Figure 15-(a) depicts a high-band added on an option 3 architecture consisting of LTE and mid-band NR. Here, EN-DC is possible with a combination of either LTE + NR FR1 or LTE + NR FR2. FR2 can provide a higher throughput with its wider bandwidth compared to FR1. Also, the network can provide a higher throughput by NR-CA and EN-DC utilizing LTE, FR1 and FR2. For throughput enhancement, NR-DC is provided within high-band coverage, and EN-DC can be provided when moving out of high-band coverage. Figure 15-(b) depicts a high-band added on an option 4 architecture consisting of eLTE(ng-eNB) and mid-band NR. NE-DC is possible with a combination of either eLTE + NR FR1 or eLTE + NR FR2. In addition, a combination of NR-CA and NE-DC between NR FR1, FR2 and eLTE with low-band can be applied.

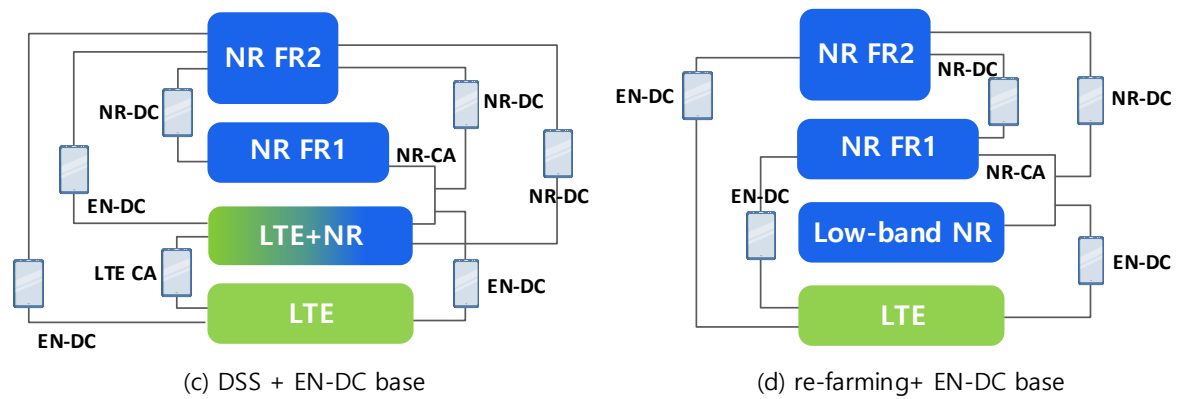

Figure 16. Low-band utilization based on DSS or re-farming

If an operator is able to adopt a new low-band FDD NR either from re-farming/DSS or from new frequency allocation as shown in Figure 16, it is possible for the operator to secure wider coverage and throughput enhancement using FR1 TDD-FDD CA, FR1-FR2 NR-DC, as well as EN-DC. To enhance throughput, NR-DC is provided within high-band coverage and EN-DC can be provided when moving out of high-band coverage with ng-eNB.

Samsung provides load balancing for efficient management for multiple frequency bands and provides access control/priority based scheduling between multiple types of devices such as LTE, NSA and SA UEs.

Voice Service

Although the request for data services is the primary driver behind the growth and evolution of 5G, voice service is still an indispensable part of mobile communication network. The Voice over New Radio (VoNR) feature provided in 5G is similar to VoLTE in 4G. VoNR is a voice solution based on IMS in 5G SA architecture. In VoNR, a UE camps on the 5G network, and both voice and data services are provided on the 5G network with gNB and 5GC. When the UE moves out of NR coverage, inter-RAT handover is initiated, and VoLTE is provided in the LTE coverage area instead.

In the early stages of 5G, a network may not support the VoNR feature if the VoNR feature has not yet been deployed on a SA architecture network, or if the network is deployed with a NSA option 3 architecture and lacks 5GC. In NSA mode with EPC, VoLTE is used for voice service using LTE while data is served by NR. However, in SA mode, VoLTE is not supported. As such, to provide a continuous voice service when a VoLTE call moves to a 5G SA network, the 3GPP has defined voice fallback features. There are two types of fallback features in 5G: Evolved Packet System (EPS) fallback and RAT fallback. In EPS fallback, if a UE tries to use voice services in a 5G network that does not support VoNR, gNB redirects or performs a handover to the LTE network, and consequently the UE is able to use voice services via VoLTE. After the voice session is terminated, the UE can move back to the 5G network. RAT fallback is similar to EPS fallback except that the UE falls back to the eLTE network controlled by the 5GC during the voice session.

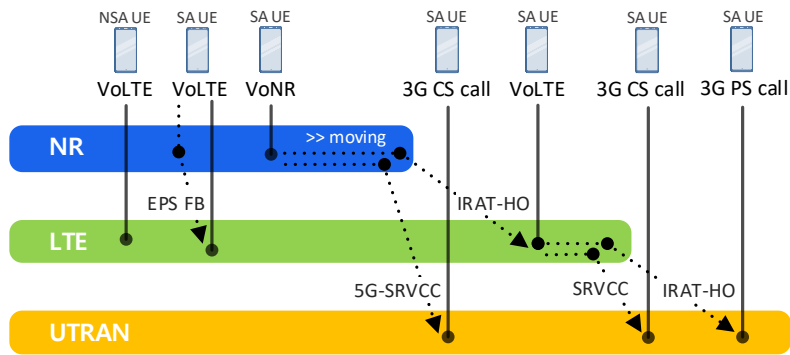

Figure 17. Voice service continuity within mobile networks

Figure 17 shows a comprehensive voice service solution for a seamless continuity within a mobile communication network. VoNR is only feasible in NR deployments equipped with 5GC and gNB. Therefore, an operator needs to utilize VoLTE service and maintain EPC for continuous voice service until VoNR is available. As an alternative to 5G voice solution for areas that do not support VoLTE and VoNR, 5G-Single Radio Voice Call Continuity (SRVCC) can be provided for a continuous voice service by UMTS Terrestrial Radio Access Network (UTRAN).

Summary

5G allows operators to provide unprecedented communication services for end-users and to explore innovative business use cases that can generate new revenue streams by means of utilizing 5G-specific services. The 3GPP provides several architecture options for NR deployment, including options that incorporate migration from the legacy LTE network. These options are divided into two categories: SA and NSA. Each migration method has its pros and cons. The SA architecture consisting of 5GC and gNB can provide full 5G services from day one, while the NSA architecture leveraging the existing LTE infrastructure provides limited 5G services. NSA can be an attractive option for customers who have interest in quickly deploying 5G by utilizing legacy network and minimizing upfront investments. However, the SA architecture is the best choice for operators that want to tap new 5G opportunities, as 5G-specific services are available only in SA architecture. By understanding and utilizing the characteristics of 5G bands, especially that of the different bands, an operator may deploy the 5G on high-band for dense and urban areas that require extremely high capacity, or deploy the 5G on mid-band for metropolitan areas to balance the benefits and tradeoffs of capacity and coverage. Advanced 5G network technologies such as Massive MIMO, dual connectivity, carrier aggregation can serve to complement the weaknesses of NR deployment and enriches 5G services for customers. 5G-specific services combined with other features enable diverse business use cases such as factory automation, smart cities, autonomous driving and healthcare area. In this way, an operator is able to secure new revenue streams.

NR SA migration with 5G RAN and CN is the key for not only offering innovative 5G services but also the potential to enhance a business by quickly addressing the emerging market. Samsung has led 5G deployment from day one and is ready to support any operator's 5G needs.

Abbreviations

3GPP	3rd Generation Partnership Project	MOCN	Multi Operator Core Network
5GC	5G Core	MR-DC	Multi-Radio Dual Connectivity
CA	Carrier Aggregation	MTC	Machine-Type Communication
CN	Core Network	NB-IoT	Narrow Band-IoT
CSFB	Circuit Switch Fallback	NE-DC	NR-E-UTRA Dual Connectivity
DC	Dual Connectivity	NGEN-DC	NG-RAN E-UTRA-NR Dual Connectivity
DECORE	Dedicated Core Network		
DSS	Dynamic Spectrum Sharing	NR	New Radio
eLTE	enhanced LTE	NR-DC	NR-NR Dual Connectivity
eMBB	enhanced Mobile Broadband	NSA	Non-Standalone
eMTC	enhanced Machine-Type Communication	PUSCH	Physical Uplink Share Channel
eNB	Evolved Node B	RAN	Radio Access Network
EN-DC	E-UTRA-NR Dual Connectivity	SA	Standalone
gNB	Next Generation Node B	SCG	Secondary Cell Group
IIoT	Industrial Internet of Things	SN	Secondary Node
IoT	Internet of Things	SRVCC	Single Radio Voice Call Continuity
ITU	International Telecommunication Union	URLLC	Ultra-Reliable Low-Latency Communication
mmWave	Millimeter Wave	UTRAN	UMTS Terrestrial Radio Access Network
mMTC	massive Machine-Type Communication	V2I	Vehicle to Infrastructure
MBB	Mobile Broadband	V2P	Vehicle to Pedestrian
MCG	Master Cell Group	V2V	Vehicle to Vehicle
MEC	Multi-access Edge Computing	V2X	Vehicle to Everything
MN	Master Node	VoLTE	Voice over LTE
		VoNR	Voice over New Radio

References

- [1] Samsung White Paper, "[Who & How: Making 5G NR Standards](#)", Jun.2018.
- [2] 3GPP TR38.801, "Radio access architecture and interface" Rel.14
- [3] 3GPP TR23.799, "Study on Architecture for Next Generation System" Rel.14
- [4] 3GPP TS37.340, "Multi-connectivity; Stage 2". Rel.16
- [5] Samsung White Paper, "[Network Slicing](#)", Apr.2020.
- [6] Samsung White Paper, "[5G Core Vision: Samsung 5G Core Vol.1](#)", Jun.2019.
- [7] Samsung White Paper, "Dynamic Spectrum Sharing", Jun.2020.

SAMSUNG

About Samsung Electronics Co., Ltd.

Samsung inspires the world and shapes the future with transformative ideas and technologies.

The company is redefining the worlds of TVs, smartphones, wearable devices, tablets, digital appliances, network systems, and memory, system LSI, foundry and LED solutions.

Address: 129 Samsung-ro, Yeongtong-gu, Suwon-si Gyeonggi-do, Korea

2020 Samsung Electronics Co., Ltd.

All rights reserved. Information in this leaflet is proprietary to Samsung Electronics Co., Ltd. and is subject to change without notice.

No information contained here may be copied, translated, transcribed or duplicated by any form without the prior written consent of Samsung Electronics.