

SAMSUNG



No. 1 TV Brand
(Global¹ and Singapore²)



Global No.1
Soundbar Brand³

Spring Sale

Unveil magical moments
with Samsung this spring



Gifts* with purchase

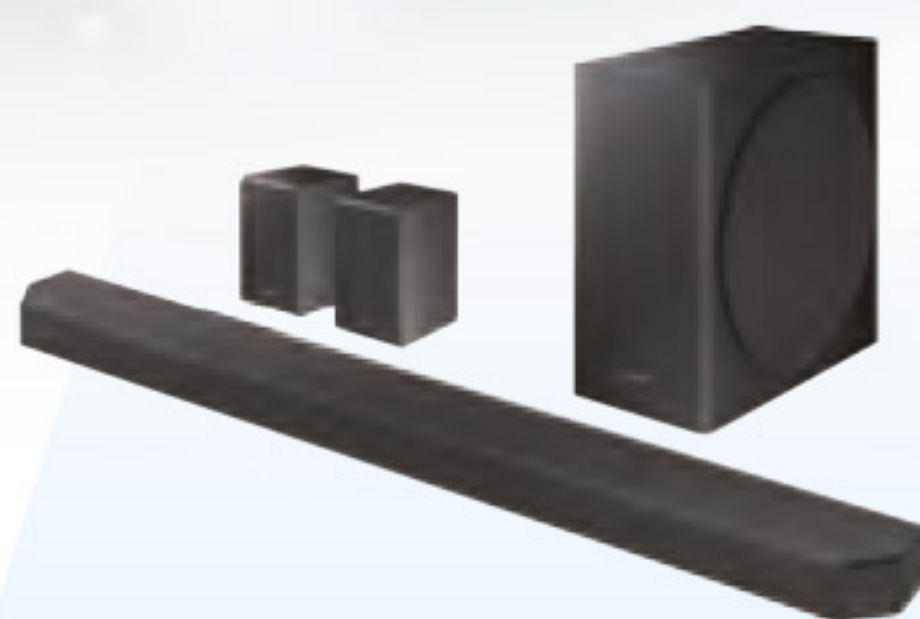

HW-Q950T
Soundbar



A pair of Galaxy
Watch Active2 BT
(44mm & 40mm)



Galaxy
Tab S6 Lite



Up to 12 Months
Entertainment
Package
worth \$500



Shopping
Voucher worth
up to \$400

Why QLED 8K

Experience the extraordinary QLED 8K
Powered by the intelligent 8K Quantum Processor



8K Resolution⁵

Unparalleled clarity with 33 million pixels, 4 times the resolution of 4K.

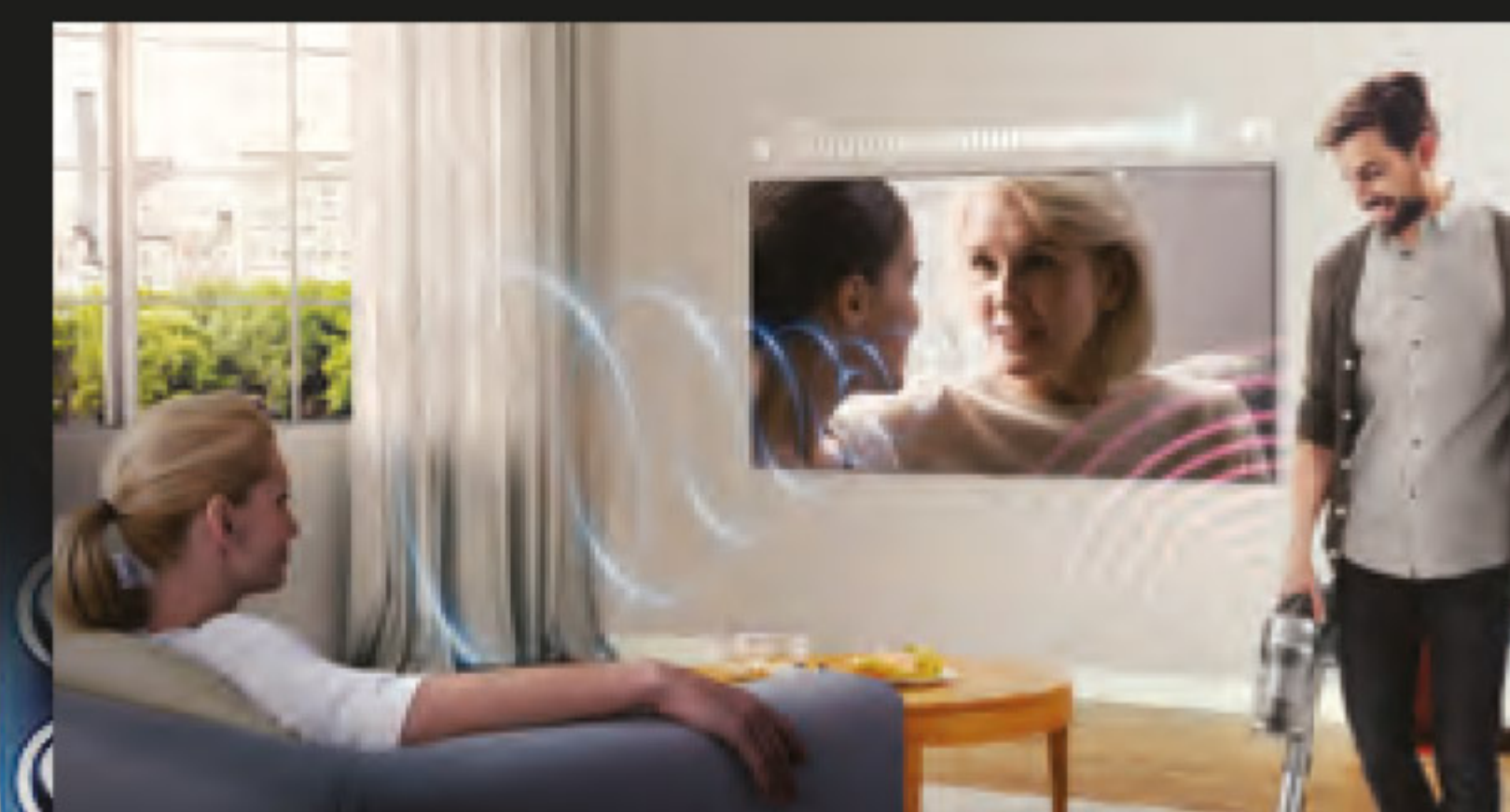

Active Voice Amplifier

QLED 8K automatically detects background noise and increases voice clarity in response.



8K AI Upscaling⁶

Upscales lower resolution images into 8K picture quality through detail restoration, noise reduction, texture creation and edge restoration.



Object Tracking Sound+⁷

Sound follows the movement in each scene for a realistic and three-dimensional audio experience.

Unrivalled design, unparalleled contrast



Infinity Screen

The nearly invisible bezel pushes your viewing experience to the limit with 99% screen-to-body ratio.

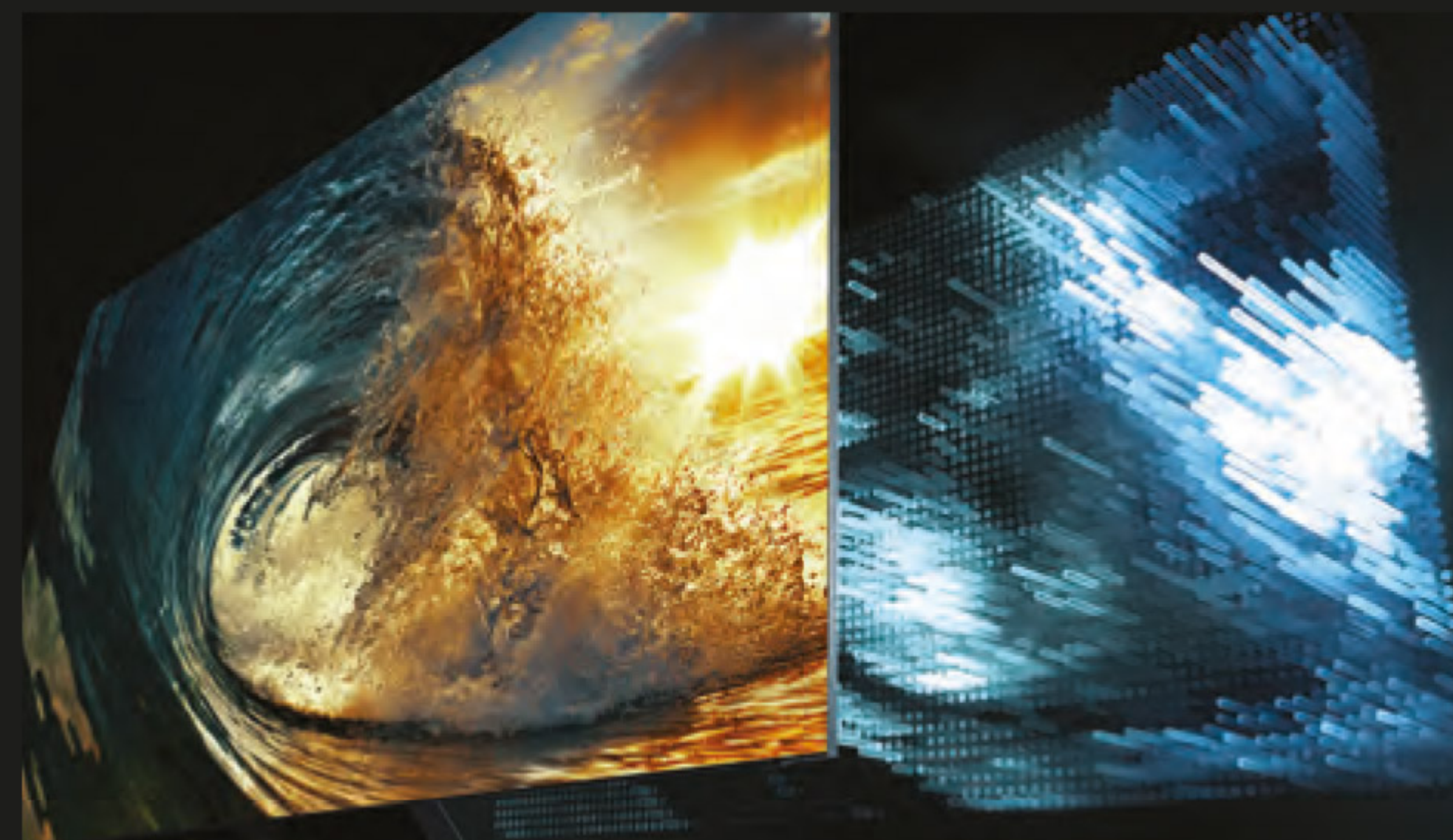

Direct Full Array⁷

Precisely controlled backlights intelligently adjust brightness by zones to deliver deeper blacks and optimised colour contrast in each scene.

INFINITY SCREEN

99%
screen-to-body ratio



Q950T

THE STRAITS TIMES
TECH
EDITOR'S CHOICE



9/10
HARDWARE
ZONE
SINGAPORE



Available in 85" | 75" | 65"
Energy rating 3 Ticks | 2 Ticks | 2 Ticks



- Resolution 7,680 x 4,320
- 100% Real Colour by Quantum Dot Technology⁴
- 8K Quantum Processor
- Direct Full Array 32x7
- Quantum HDR 32x⁸
- 8K AI Upscaling⁶
- Object Tracking Sound+
- Active Voice Amplifier
- Infinity Screen
- Anti-Glare Technology

- One Invisible Connection (5m)⁹
- One Connect Box¹⁰
- No Gap Wall-Mount¹¹
- One Master Remote Control¹²
- Bixby Voice Assistant (Hands-free control)¹³
- Tap View & Screen Mirroring¹⁴
- Multi View¹⁵
- Magic Screen+¹⁶
- eARC (HDMI 2.1)



Q800T



Available in 82" | 75" | 65"
Energy rating 3 Ticks | 2 Ticks | 2 Ticks

- Resolution 7,680 x 4,320
- 100% Real Colour by Quantum Dot Technology⁴
- 8K Quantum Processor
- Direct Full Array 24x7
- Quantum HDR 16x⁸
- 8K AI Upscaling⁶
- Object Tracking Sound+
- Active Voice Amplifier
- Anti-Glare Technology
- One Master Remote Control¹²

- Bixby Voice Assistant (Hands-free control)¹³
- Tap View & Screen Mirroring¹⁴
- Multi View¹⁵
- Magic Screen+¹⁶
- eARC (HDMI 2.1)

BUY 85" | 75" FREE*

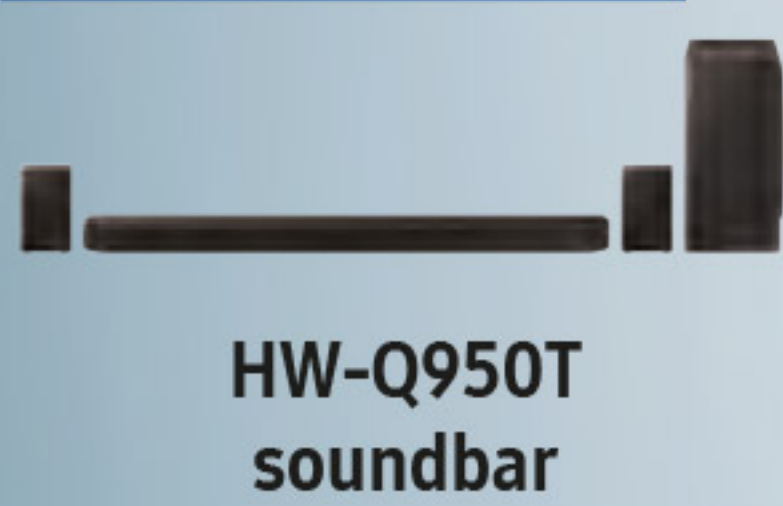

12 months entertainment package worth \$500



Concierge service

BUY 85" | 75" FREE*

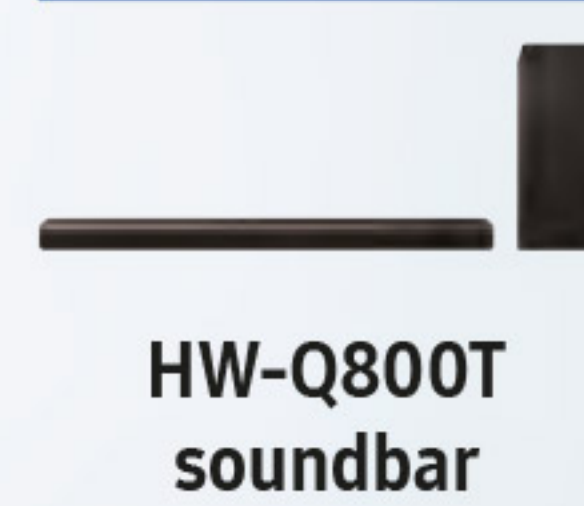

12 months entertainment package worth \$500



Concierge service

BUY 65" FREE*

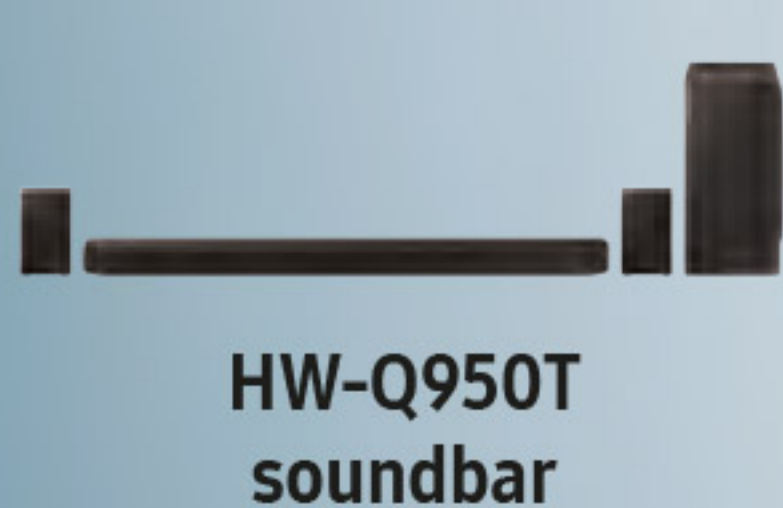

12 months entertainment package worth \$500



43" Crystal UHD Smart TV TU8000



Concierge service

BUY 65" FREE*

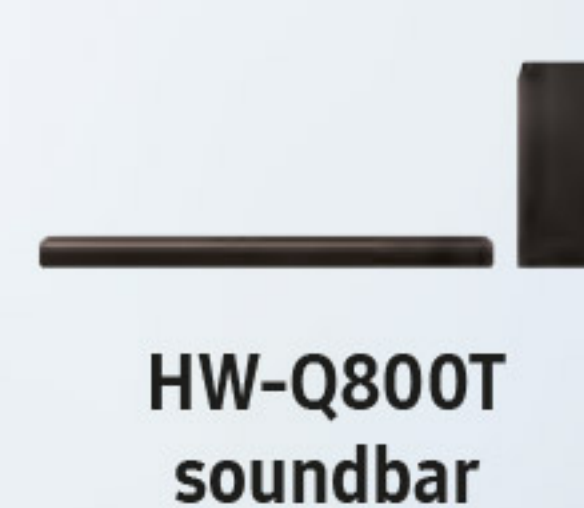

12 months entertainment package worth \$500



43" Crystal UHD Smart TV TU8000



Concierge service

You will enjoy:

- Complimentary delivery
- Installation and/or wall mounting
- Set up of Smart TV
- 1-1 Product Demonstration

QLED 8K Concierge Service¹⁷

Save time on waiting, so you can enjoy the entertainment you love immediately.

Why QLED

100% Real Colour⁴ only with Quantum Dot Technology

Experience 100% Real Colour⁴ with Samsung's exclusive **Quantum Dot Technology**. With the use of nano-sized Quantum Dots, white light is converted into coloured light that retains colour accuracy regardless of brightness level, resulting in true-to-life picture quality.

Colour Volume



Other TVs



QLED

100% Colour Volume

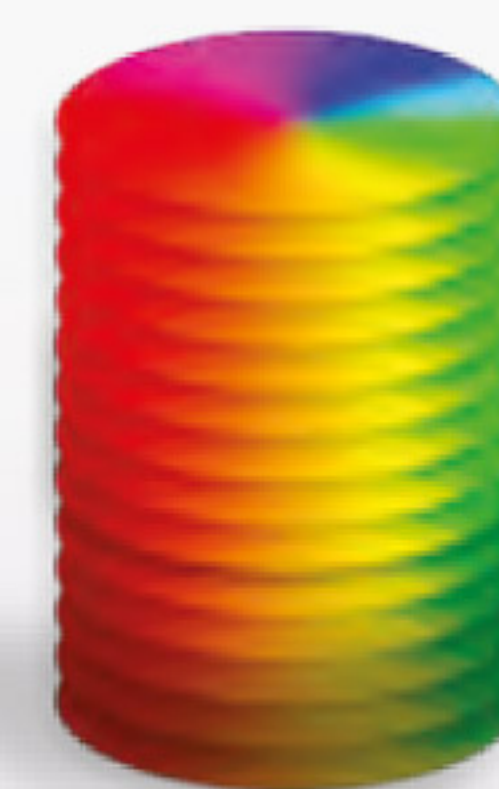

Anti-Glare Technology

With extremely low light reflectivity, QLED delivers incredible brightness and impeccable contrast across a wide variety of lighting environments.



Without QLED Anti-Glare Technology

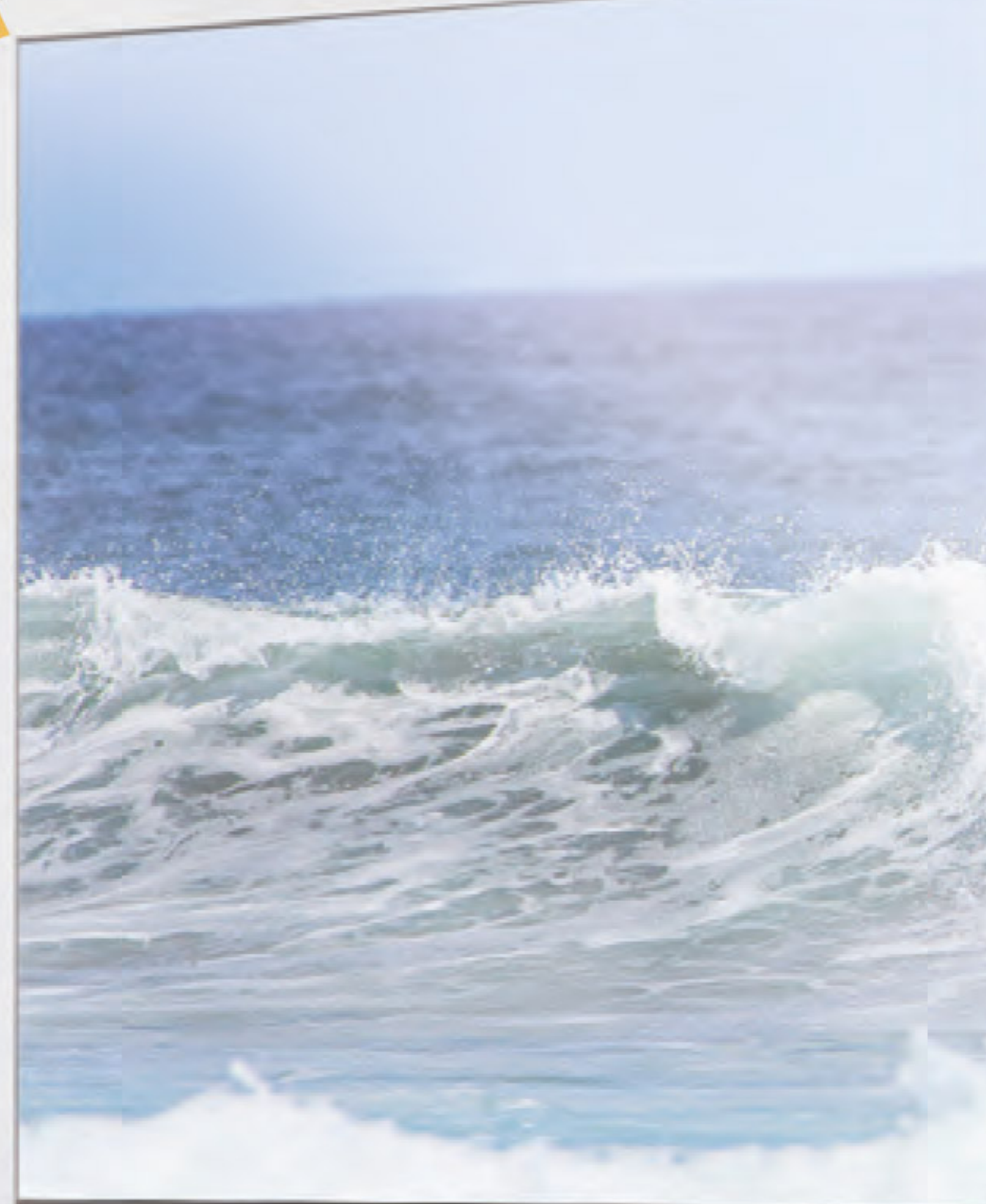

With QLED Anti-Glare Technology



10 YEARS ASSURANCE

Against Burn-In¹⁸

QLED offers you the same brilliant colours and picture quality for a long time with no pixel degradation.

One Invisible Connection⁹ & One Connect Box¹⁰

Keep messy cables and devices out of view by connecting them to the One Connect Box¹⁰ instead of the back of the TV.

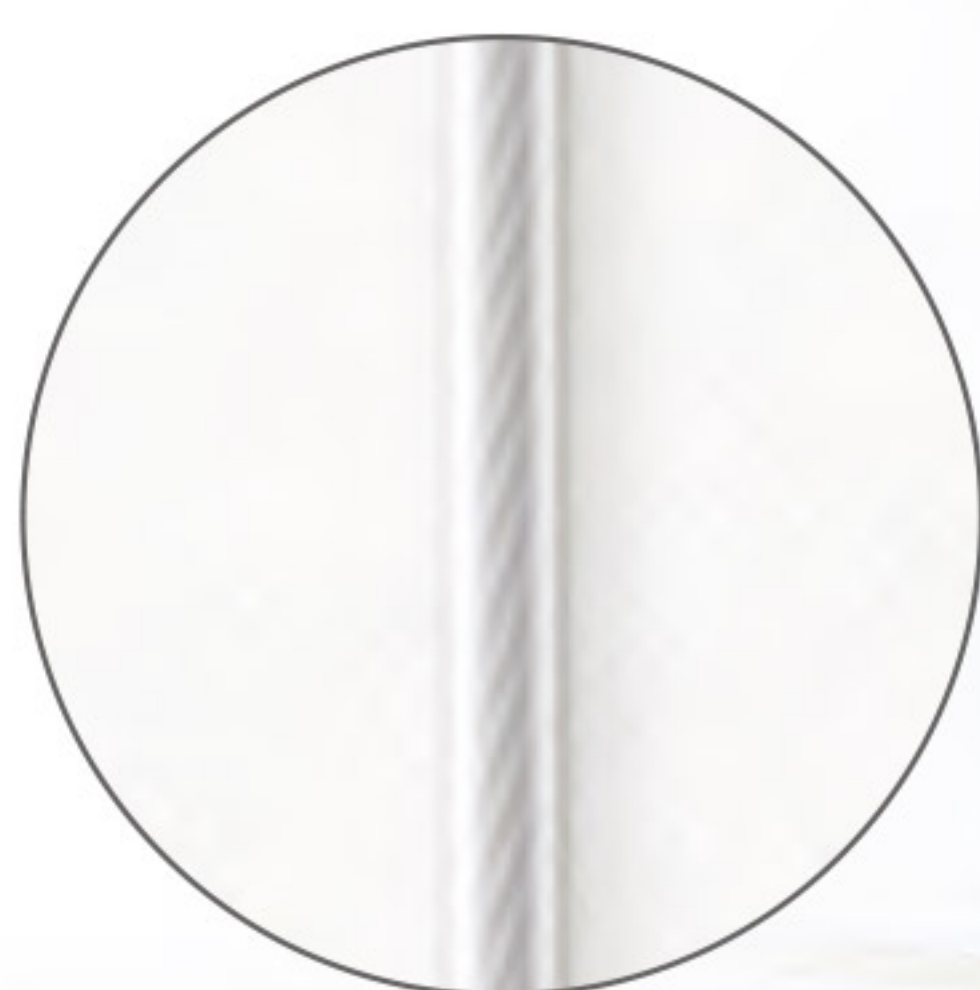

Eye-safety certified¹⁹

Protect your vision while enjoying your content. Tested and certified by VDE Germany.

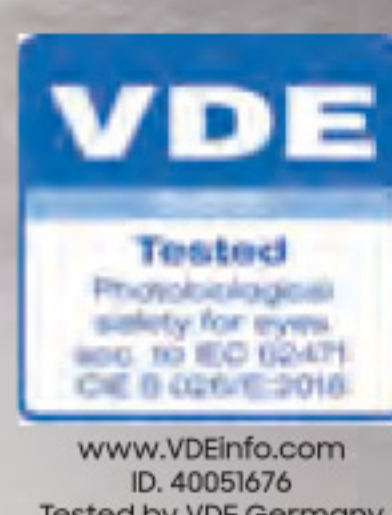

Direct Full Array | Precise and unparalleled contrast

Q95T

Available in 75" | 65" | 55"
Energy rating 3 Ticks | 3 Ticks | 3 Ticks



- Resolution 3,840 x 2,160
- 100% Real Colour by Quantum Dot Technology⁴
- 4K Quantum Processor
- Direct Full Array 16x⁷
- 4K AI Upscaling⁶
- Object Tracking Sound
- Active Voice Amplifier
- Anti-Glare Technology
- One Invisible Connection (5m)⁹
- One Connect Box¹⁰
- No Gap Wall-Mount¹¹
- One Master Remote Control¹²
- Bixby Voice Assistant (Hands-free control)¹³
- Tap View & Screen Mirroring¹⁴
- Multi View¹⁵
- Magic Screen+¹⁶
- eARC (HDMI 2.1)

BUY 75" FREE*

- 9 months entertainment package worth \$375
- Delivery & installation

BUY 65" FREE*

- 43" FHD Smart TV T6000
- A pair of Galaxy watch active2 BT (44mm & 40mm)
- Shopping voucher worth \$400
- 9 months entertainment package worth \$375
- Wall-mount installation

BUY 55" FREE*

- 43" FHD Smart TV T6000
- Shopping voucher worth \$200
- 6 months entertainment package worth \$250
- Wall-mount installation

Q80T

Available in 65" | 55"
Energy rating 3 Ticks | 3 Ticks



- Resolution 3,840 x 2,160
- 100% Real Colour by Quantum Dot Technology⁴
- 4K Quantum Processor
- Direct Full Array 8x⁷
- 4K AI Upscaling⁶
- Object Tracking Sound (not available on 49")
- Active Voice Amplifier
- One Master Remote Control¹²
- Bixby Voice Assistant (Hands-free control)¹³
- Tap View & Screen Mirroring¹⁴
- Multi View¹⁵
- Magic Screen+¹⁶
- eARC (HDMI 2.1)

BUY 65" FREE*

- 43" FHD Smart TV T6000
- A pair of Galaxy watch active2 BT (44mm & 40mm)
- Shopping voucher worth \$400
- 9 months entertainment package worth \$375
- Wall-mount installation

BUY 55" FREE*

- 43" FHD Smart TV T6000
- Shopping voucher worth \$200
- 6 months entertainment package worth \$250
- Wall-mount installation

Dual LED | Warm and cool backlight enhances contrast and colour gradation

Q70T

Available in 85" | 75" | 65" | 55"
Energy rating 4 Ticks | 4 Ticks | 3 Ticks | 3 Ticks



- Resolution 3,840 x 2,160
- 100% Real Colour by Quantum Dot Technology⁴
- 4K Quantum Processor
- Dual LED
- 4K AI Upscaling⁶
- Adaptive Picture
- One Master Remote Control¹²
- Bixby Voice Assistant (Hands-free control)¹³
- Tap View & Screen Mirroring¹⁴
- Multi View¹⁵
- Magic Screen+¹⁶
- eARC (HDMI 2.1)

BUY 85" | 75" FREE*

- A pair of Galaxy watch active2 BT (44mm & 40mm)
- 9 months entertainment package worth \$375
- Delivery & installation

BUY 65" FREE*

- 9 months entertainment package worth \$375

BUY 55" FREE*

- 6 months entertainment package worth \$250

Q60T

Available in 75" | 65" | 55" | 50" | 43"
Energy rating 4 Ticks | 4 Ticks | 4 Ticks | 4 Ticks | 4 Ticks



- Resolution 3,840 x 2,160
- 100% Real Colour by Quantum Dot Technology⁴
- Quantum Processor Lite
- Dual LED
- Quantum HDR⁸
- One Master Remote Control¹²
- Bixby Voice Assistant¹³
- SmartThings²⁰
- Tap View & Screen Mirroring¹⁴
- Multi View¹⁵
- Magic Screen¹⁶

BUY 75" FREE*

- A pair of Galaxy watch active2 BT (44mm & 40mm)
- Shopping voucher worth \$200
- 9 months entertainment package worth \$375
- Delivery & installation

BUY 65" FREE*

- Shopping voucher worth \$200
- 9 months entertainment package worth \$375

BUY 55" FREE*

- Shopping voucher worth \$100
- 6 months entertainment package worth \$250

BUY 50" | 43" FREE*

- 6 months entertainment package worth \$250

The Frame, LS03

TV when it's on, art when it's off

Available in Energy rating 75" | 65" | 55"
4 | 4 | 3
TICKS TICKS TICKS



Complimentary 4 Months Art Store Subscription²¹

Bring world-class museums and galleries into your home with **Art Store**²².

- Resolution 3,840 x 2,160
- Art Mode
- 100% Real Colour by Quantum Dot Technology⁴
- 4K Quantum Processor
- Dual LED
- 4K AI Upscaling⁶
- Adaptive Picture
- Active Voice Amplifier
- One Invisible Connection (5m)⁹
- One Connect Box¹⁰
- No Gap Wall-Mount¹¹
- One Master Remote Control (White)¹²
- Tap View & Screen Mirroring¹⁴
- Multi View¹⁵
- Magic Screen⁺¹⁶
- eARC (HDMI 2.1)

BUY 75" FREE*



BUY 65" FREE*

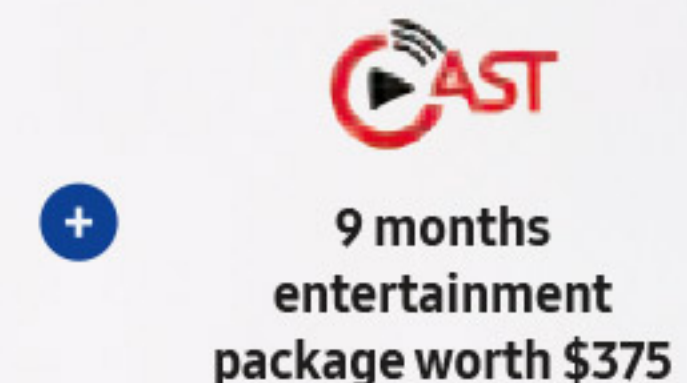
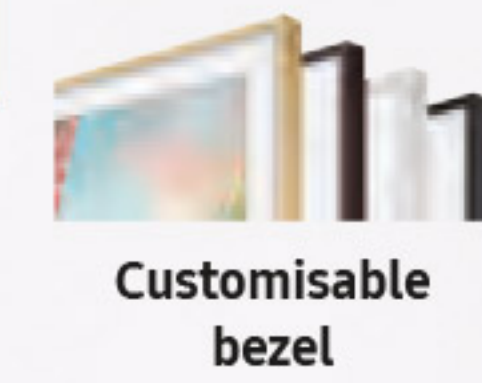

Plus, choose between:

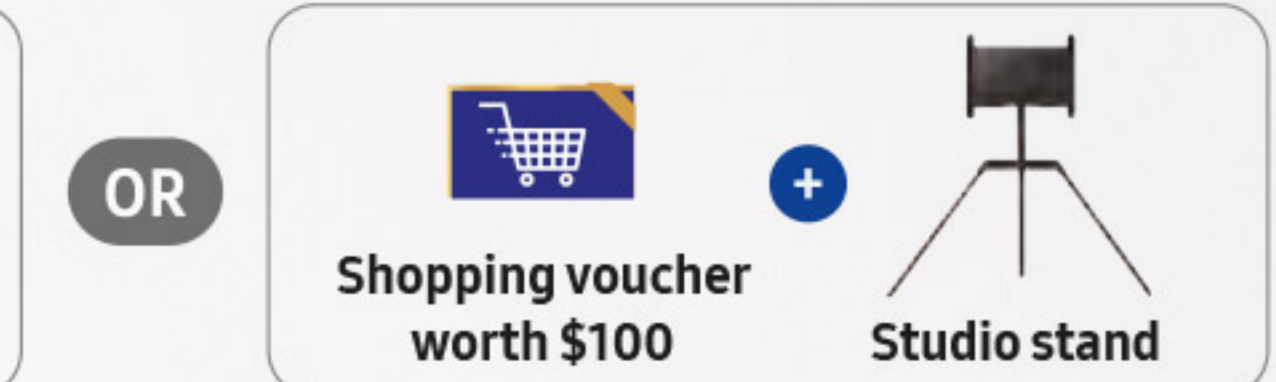
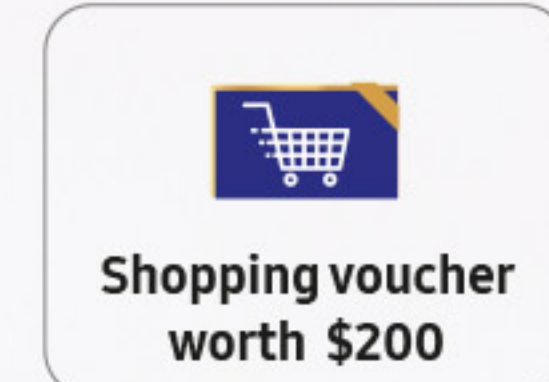

BUY 55" FREE*

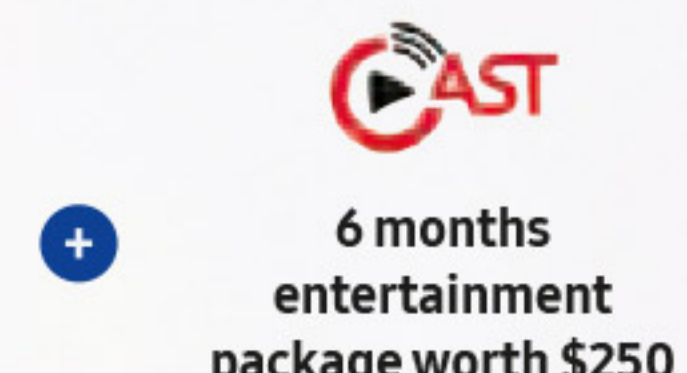
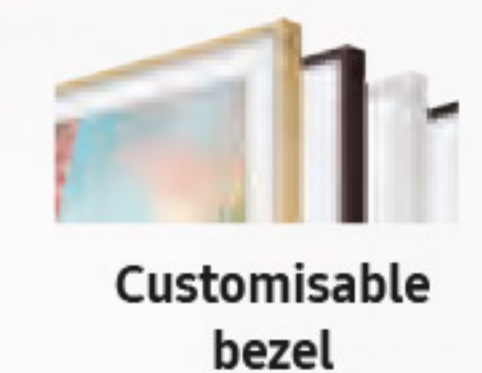

The Serif, LS01

Unconditionally beautiful

Available in Energy rating 55" | 43"
4 | 3
TICKS TICKS

- Resolution 3,840 x 2,160
- 100% Real Colour by Quantum Dot Technology⁴
- 4K Quantum Processor
- 4K AI Upscaling⁶
- Adaptive Picture
- Active Voice Amplifier
- One Master Remote Control¹² (White)
- Tap View & Screen Mirroring¹⁴
- NFC Technology on TV²³
- Multi View¹⁵
- Magic Screen⁺¹⁶
- eARC (HDMI 2.1)



Iconic Design by **Bouroullec Brothers**

Make a distinct, sophisticated statement with the I-shaped profile.

FREE*

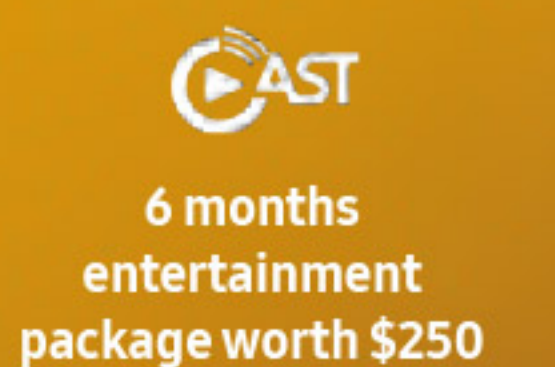

Mobile entertainment, better on TV

World's first TV designed for viewing mobile content



The Sero, LS05

Available in 43" Energy rating 3 TICKS

- Resolution 3,840 x 2,160
- Auto Rotation
- 100% Real Colour by Quantum Dot Technology⁴
- 4K Quantum Processor
- 4K AI Upscaling⁶
- Adaptive Picture
- Active Voice Amplifier
- Powerful 4.1ch 60w Speaker
- One Master Remote Control (White)¹²
- Tap View & Screen Mirroring¹⁴
- Portrait Mode
- Magic Screen+¹⁶
- eARC (HDMI 2.1)

Screen rotates to fit your content



Portrait for mobile view



Landscape for TV programmes

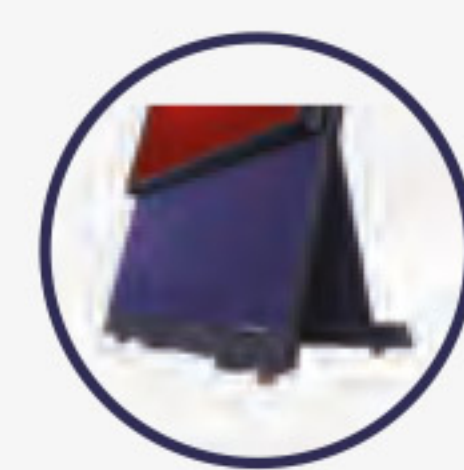

Bring your TV anywhere with The Sero Wheel²⁴

FREE*



The Sero Wheel



6 months entertainment package worth \$250

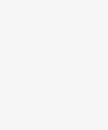

Galaxy Tab S6 Lite

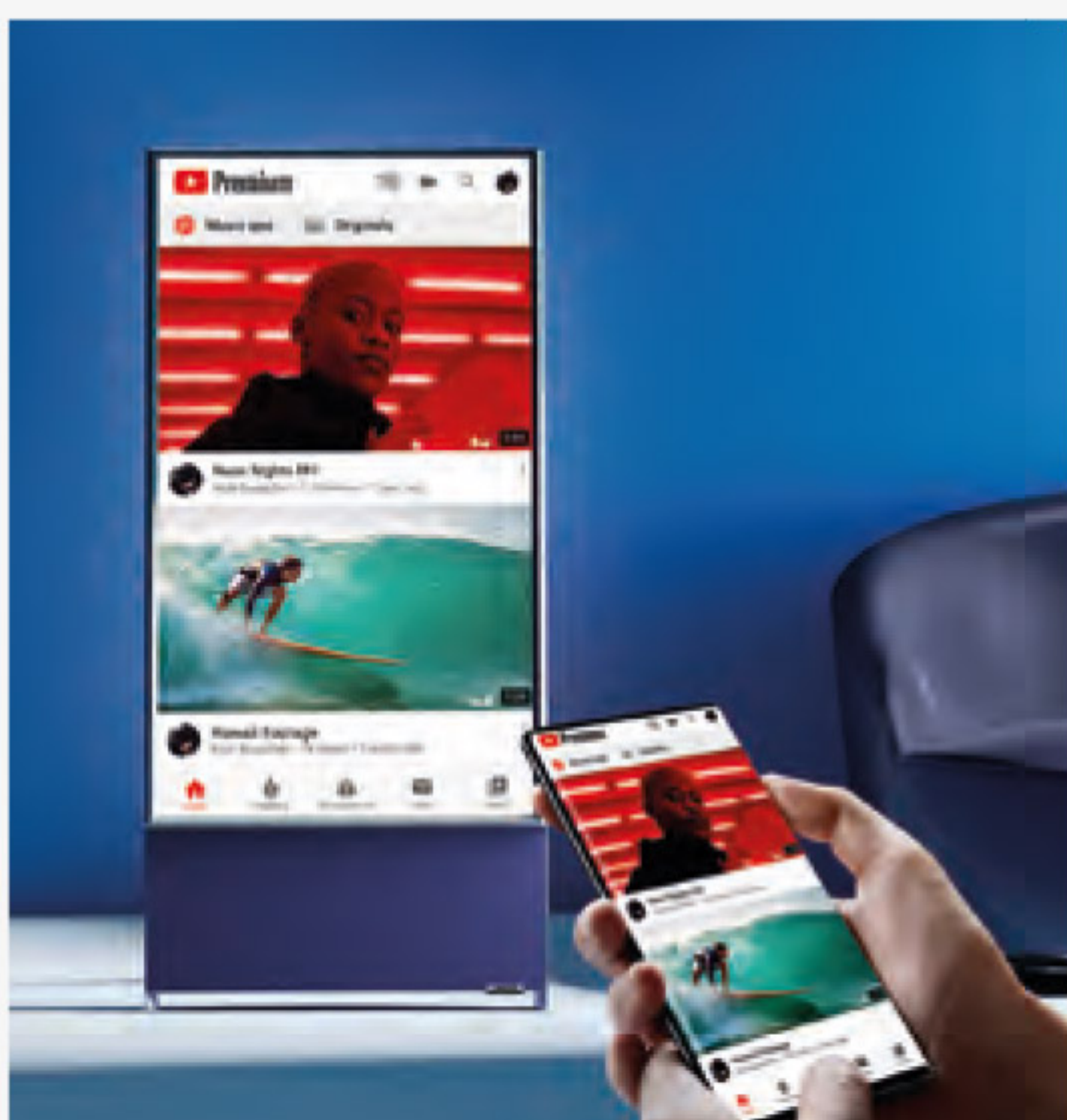

Enjoy all your content in 4K resolution

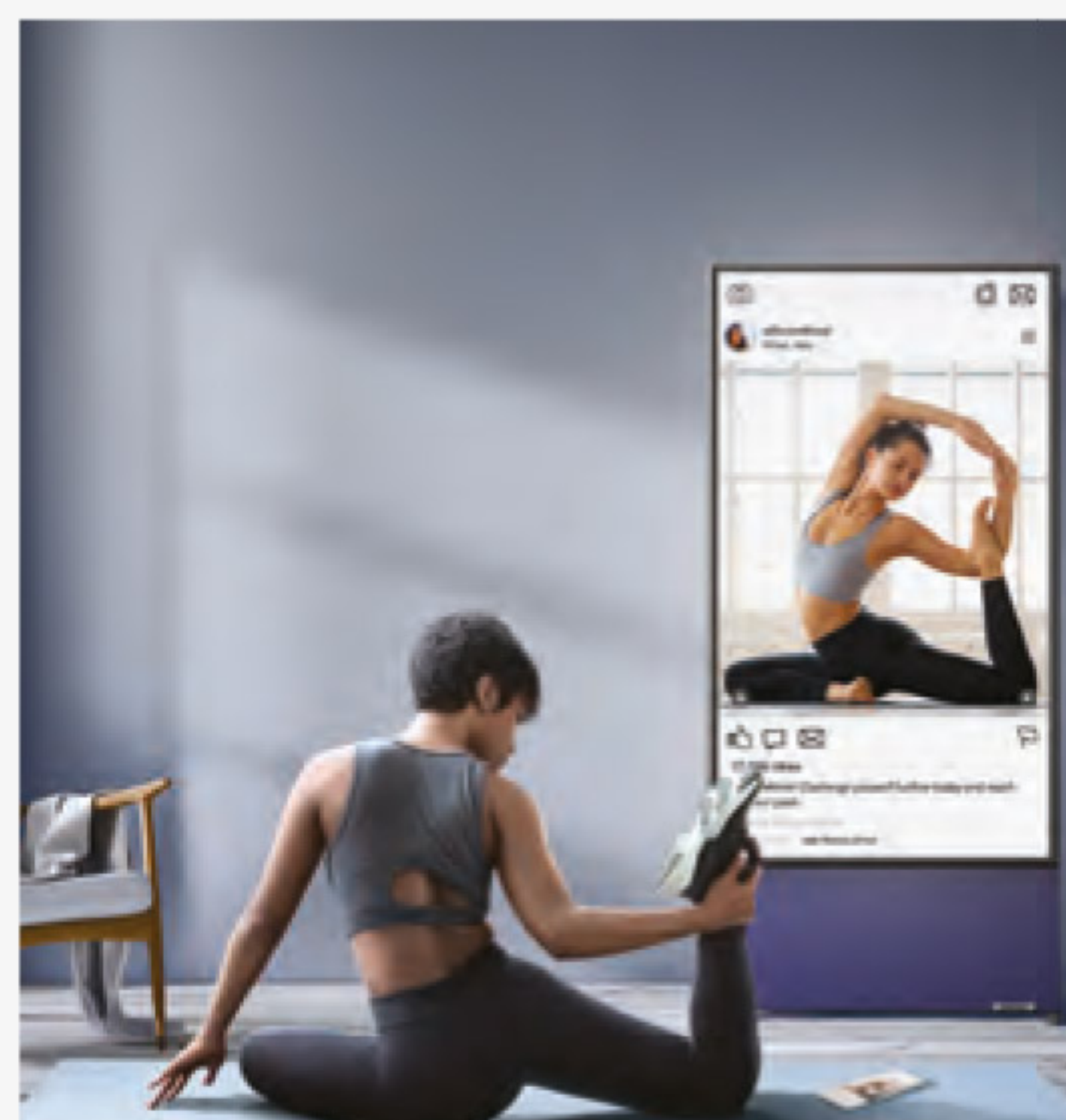

View your mobile content with ease on a bigger screen¹⁴

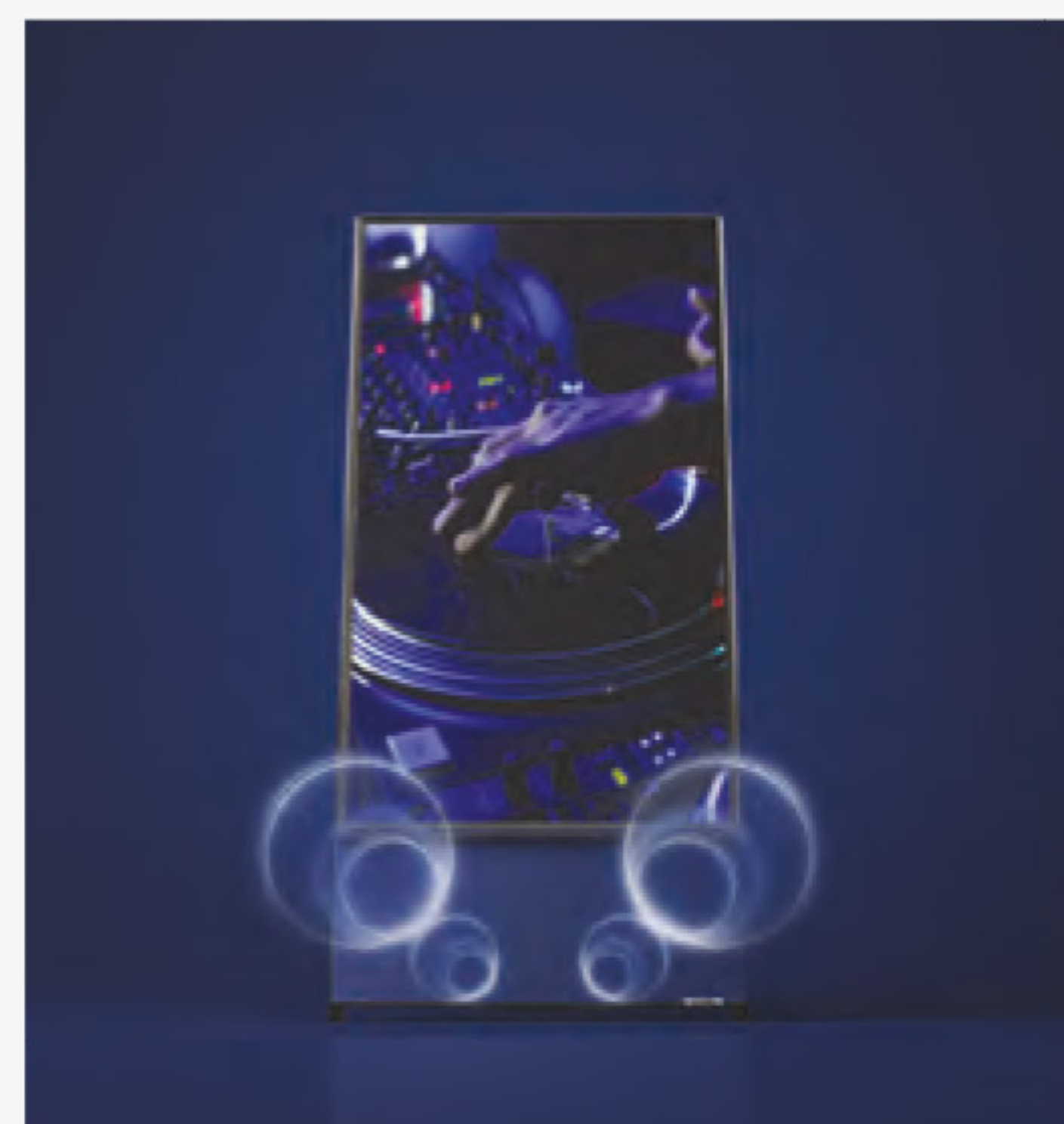

Powerful sound with 4.1ch 60w speakers



Recycle your TV packaging into useful household items



Studio Stand
VG-SEST11K
 \$399

Compatible with 49" to 65" QLED and Crystal UHD TVs
 (excluding The Serif and The Sero).

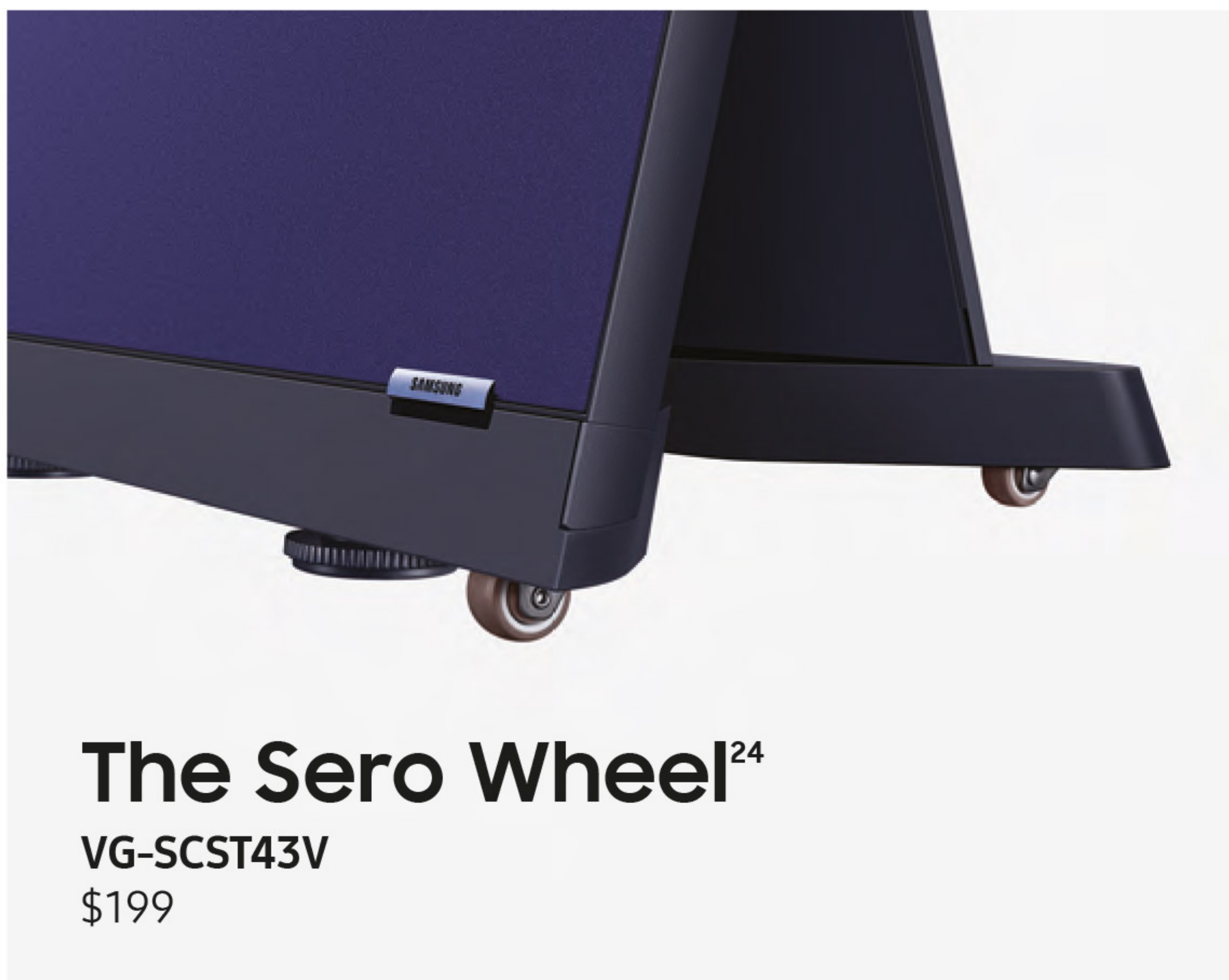

The Sero Wheel²⁴
VG-SCST43V
 \$199

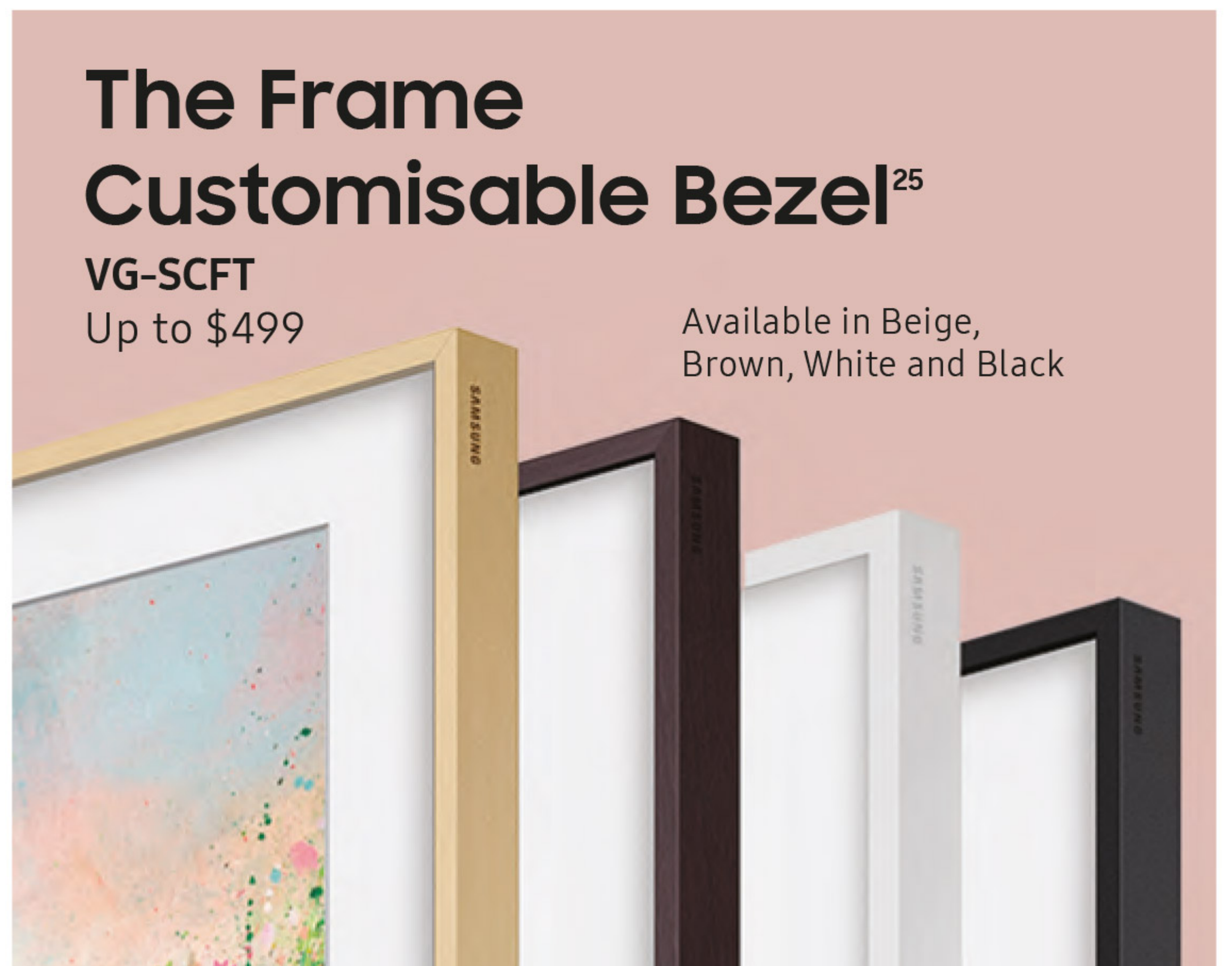

The Frame
Customisable Bezel²⁵

VG-SCFT
 Up to \$499

Available in Beige,
 Brown, White and Black

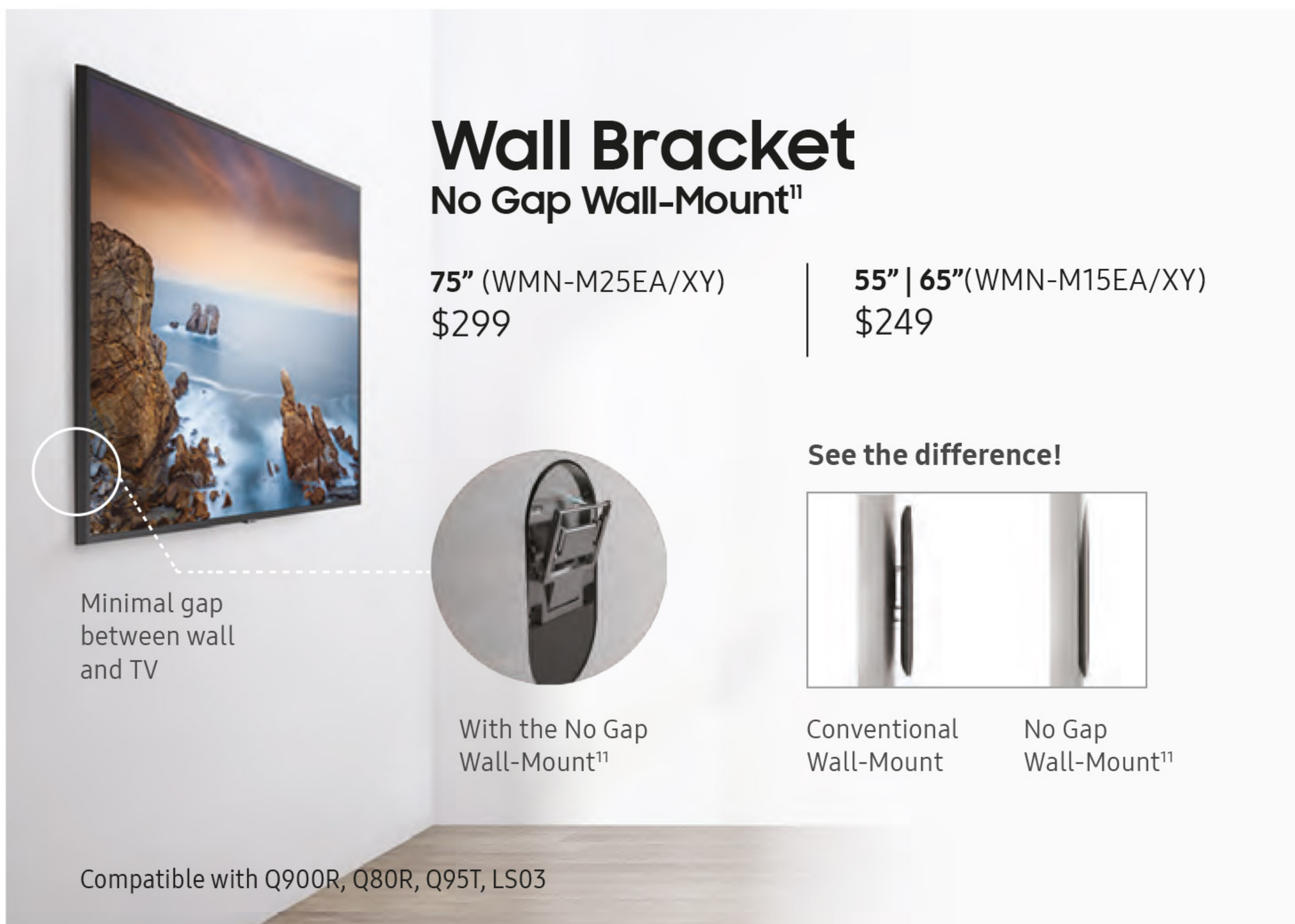

Wall Bracket
No Gap Wall-Mount¹¹

75" (WMN-M25EA/XY)
 \$299

55" | 65" (WMN-M15EA/XY)
 \$249

See the difference!



Conventional
 Wall-Mount

No Gap
 Wall-Mount¹¹

Minimal gap
 between wall
 and TV

With the No Gap
 Wall-Mount¹¹

Compatible with Q900R, Q80R, Q95T, LS03

**One Invisible
 Connection⁹**

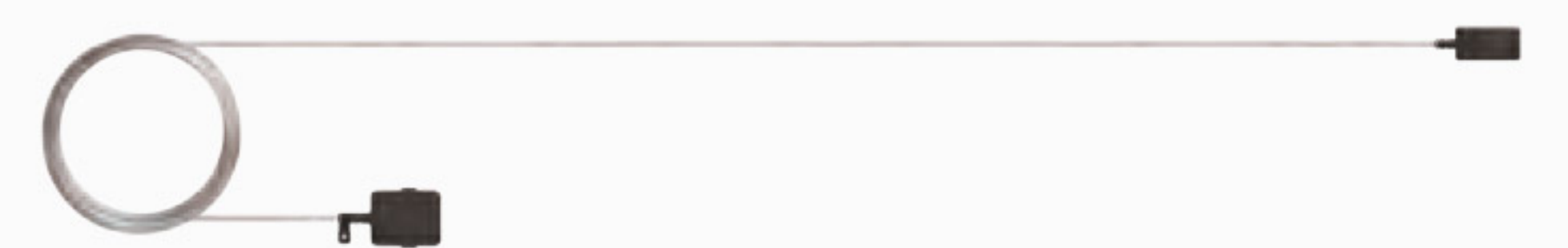

Available options:

15m cable
VG-SOCR15
 \$299

10m cable
VG-SOCT87
 \$299

15m: Compatible with Q80R, Q95T, LS03 (55", 65", 75")
 10m: Compatible with Q950T (85", 75", 65")

Why Crystal UHD

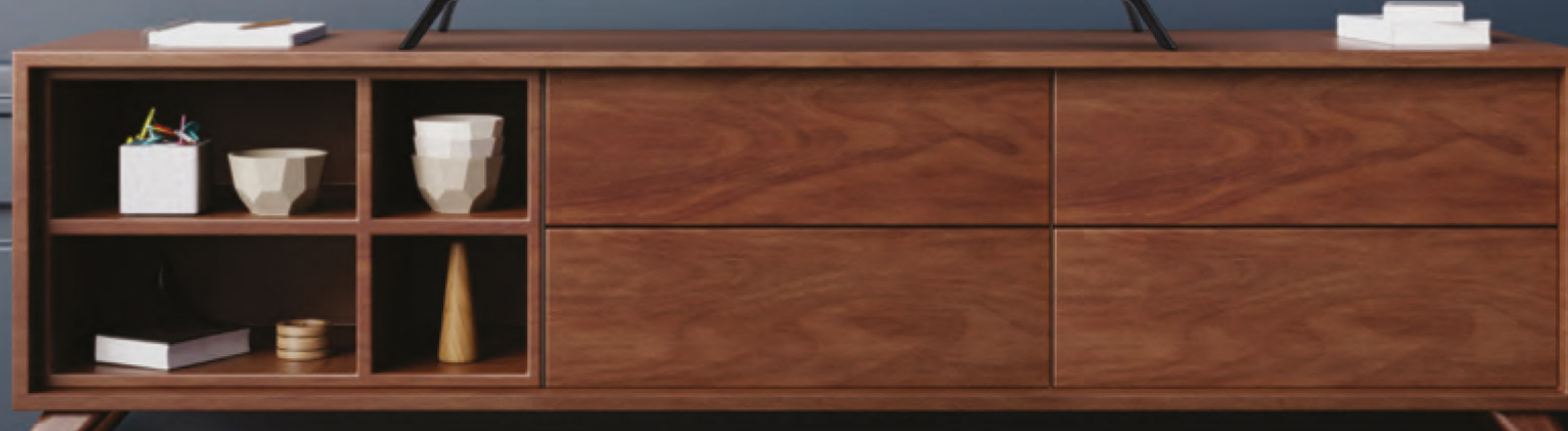

Crystal Display

Nanostructured particles produce vivid and true-to-life colours.



HDR Powered by HDR 10+²⁶

Discover hidden details with powerful contrast.



One Master Remote Control¹²

Control all your devices with a single remote control.

TU8000



Available in 82" | 65" | 55" | 50" | 43"
Energy rating 4 Ticks 4 Ticks 4 Ticks 4 Ticks 4 Ticks

- Resolution 3,840 x 2,160
- Crystal Display
- 4K Crystal Processor
- HDR powered by HDR 10+²⁶
- One Master Remote Control¹²
- Bixby Voice Assistant¹³
- Tap View & Screen Mirroring¹⁴
- Magic Screen¹⁶

BUY 82" FREE*

A pair of Galaxy watch active2 BT (44mm & 40mm) + Shopping voucher worth \$200 + 6 months entertainment package worth \$250 + Delivery & installation

BUY 65" FREE*

Shopping voucher worth \$100 + 6 months entertainment package worth \$250

BUY 55" FREE*

Shopping voucher worth \$100 + 3 months entertainment package worth \$125

BUY 50" | 43" FREE*

3 months entertainment package worth \$125

TU7000



Available in 75" | 65" | 55" | 50" | 43"
Energy rating 4 Ticks 4 Ticks 4 Ticks 4 Ticks 4 Ticks

- Resolution 3,840 x 2,160
- Crystal Display
- 4K Crystal Processor
- HDR powered by HDR 10+²⁶
- One Master Remote Experience
- Tap View & Screen Mirroring¹⁴

BUY 75" FREE*

6 months entertainment package worth \$250 + Delivery & installation

BUY 65" FREE*

6 months entertainment package worth \$250

BUY 55" | 50" | 43" FREE*

3 months entertainment package worth \$125

A truly intelligent experience with Samsung Smart TV

Smart home



Smart entertainment

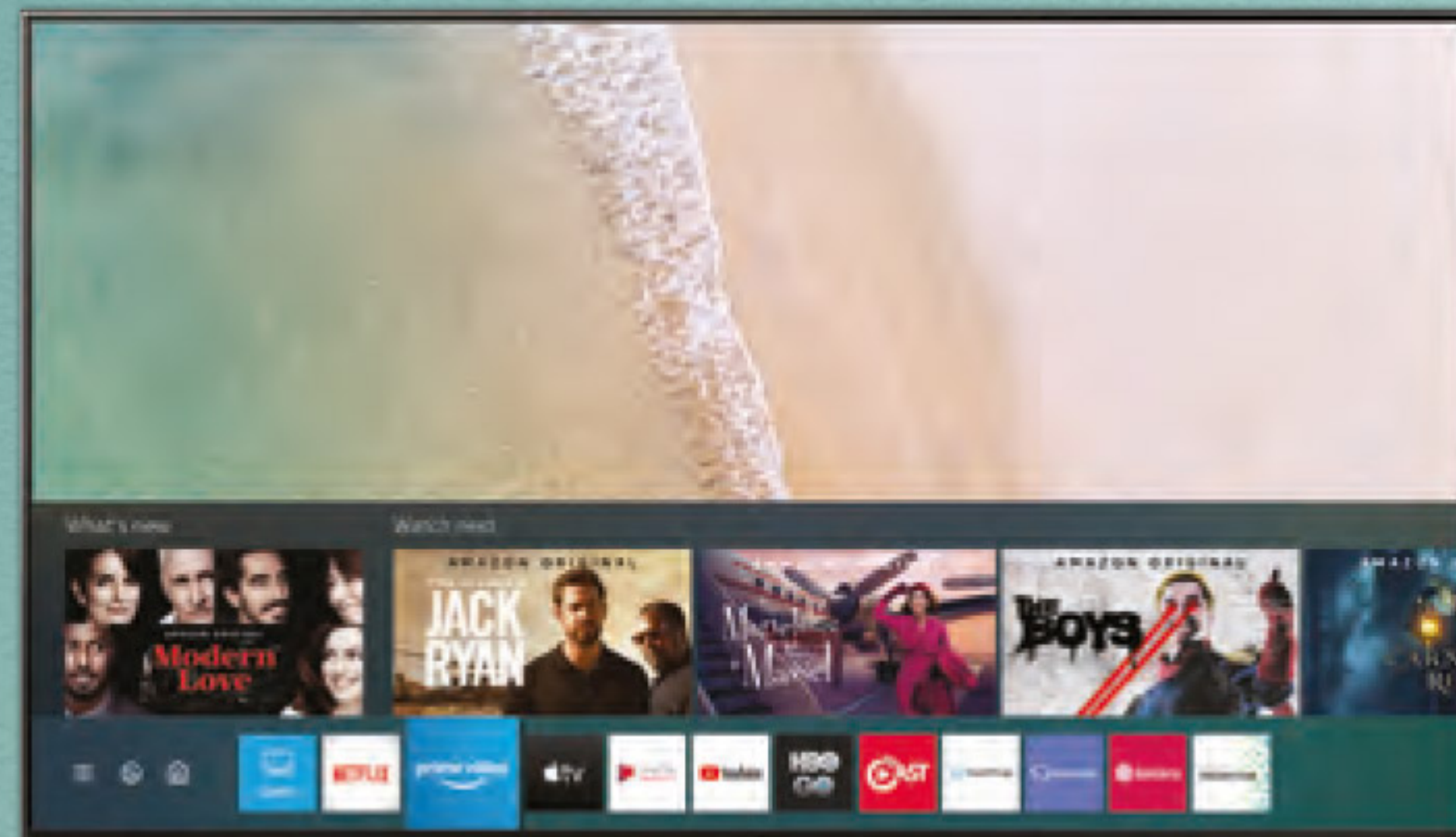

Smart connectivity



Control your devices the smarter way

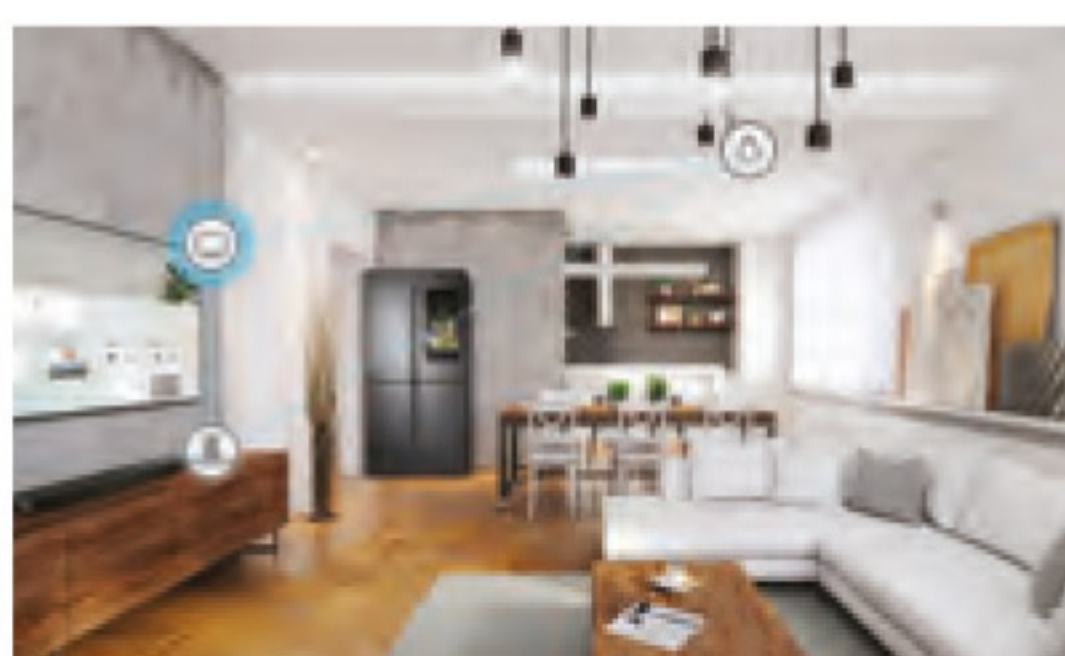

Monitor your home security²⁷ with your Samsung Smart TV²⁸.

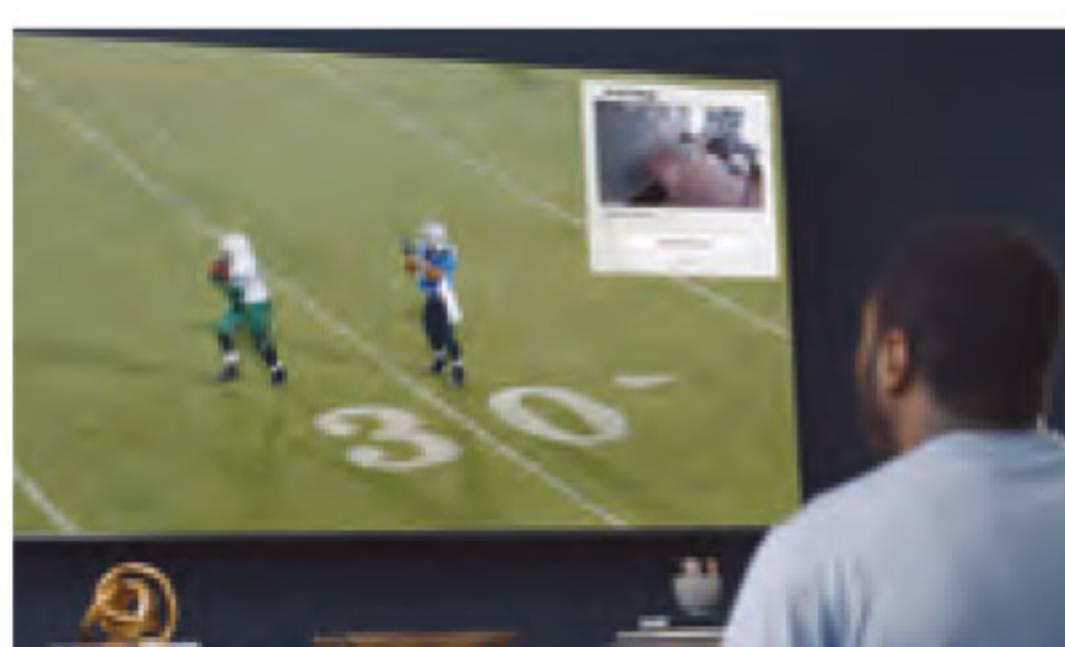

Control your smart home devices²⁹ from your Samsung Smart TV²⁸.



Control your TV with just your voice. Say what you want to the One Master Remote Control¹² and your voice assistant will deliver.

One-stop entertainment³⁰

Global Apps

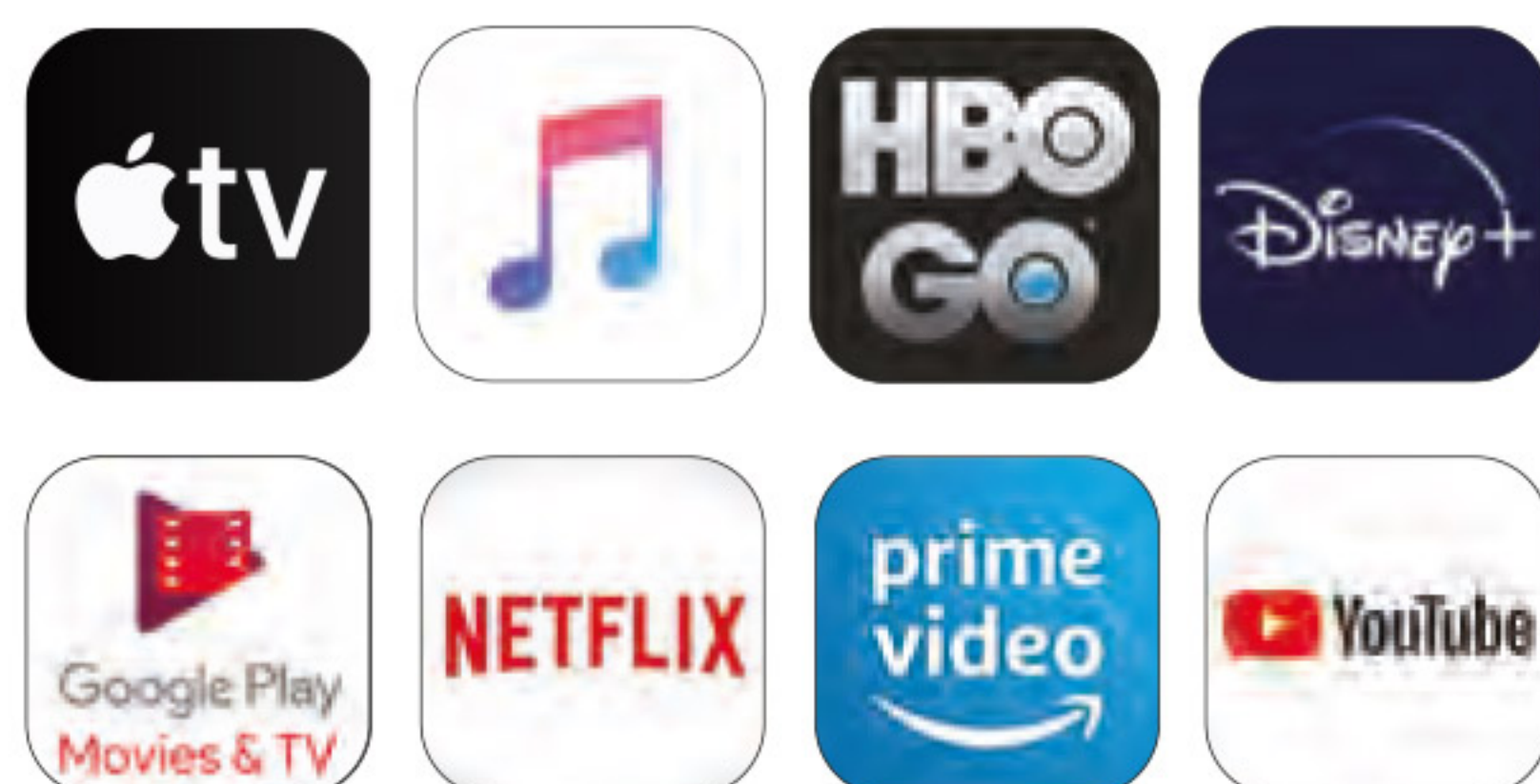

Local Apps



Easy navigation



One Master Remote Control¹²

Control all your devices with a single remote control.

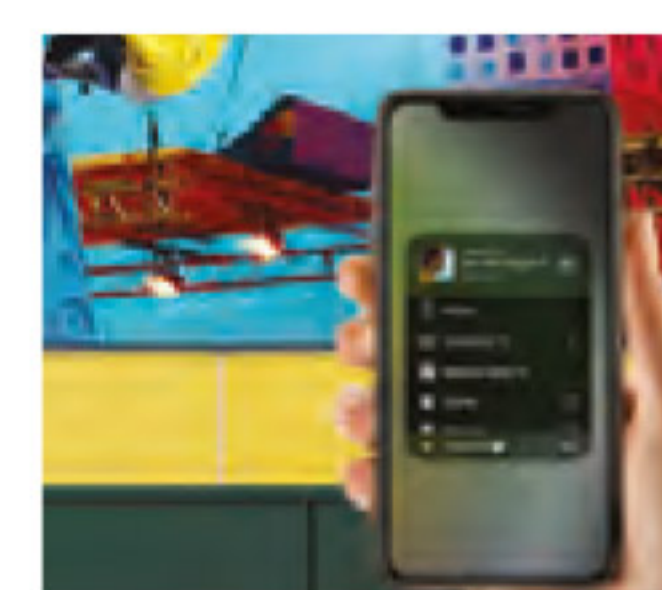

Works with AirPlay 2³¹

Enjoy watching TV shows or movies from your smartphone via Screen Mirroring or AirPlay 2 on your Samsung TV.



Tap View¹⁴

Tap your smartphone on your TV and instantly connect your mobile content to a bigger screen.



Multi View¹⁵

Take your mobile experience to the big screen by mirroring your phone on your TV. Multi View allows you to simultaneously play your favourite TV programme alongside your mobile content so you don't miss out on any action.

Bigger screen, bigger entertainment

Immersive viewing experience with Samsung large screen TV

1 Watch your favourite movies come to life

2 Thrill-of-the-stadium experience at home

3 Dive deep into the action and win more games



Recommended TV viewing distance

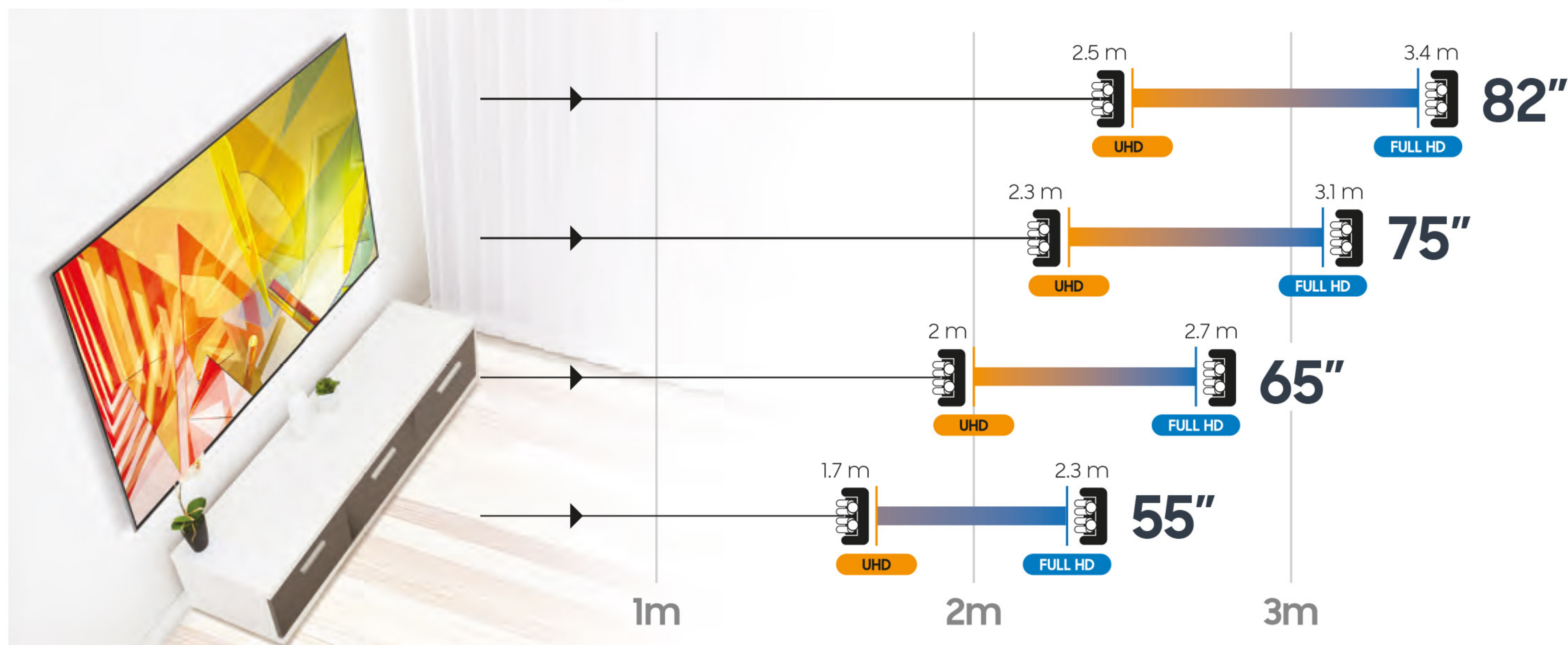

The above recommendations are provided for general guidance and information purposes only. Source: Rtings < <https://www.rtings.com/tv/reviews/by-size/size-to-distance-relationship> >

Unlimited entertainment

Start enjoying your brand-new Smart TV with on-demand entertainment

Weekend Goals
(Exclusive to Samsung TV)

Education Plus

Chinese Plus



Up to 12 months FREE* subscription



Enjoy up to 5 LIVE Premier League matches, each match weekend. Plus, get instant access to Chinese dramas and documentaries with Singtel CAST.





Official Broadcaster

Users do not have to be a Singtel subscriber to use Singtel Cast App. Singtel Cast App is available on Samsung Smart TVs. Connection to the Internet is required. Optimal viewing experience by Fibre and LAN connection. You will be charged for your monthly membership fee at the end of the complimentary subscription period unless you cancel your membership prior to the end of the complimentary subscription period. Third-party terms and conditions apply. Weekend Goals pack includes Mio Stadium CH108, Fox Sports, Fox Sports 2 and Fox Sports 3.

Up to \$550* cashback with TV trade-in
 Immediate valuation available in-store!





Trade-in with 3 simple steps

- 1**  Purchase selected 2020 43" and above Samsung QLED/UHD/Lifestyle TVs to be eligible for trade-in.
- 2**  On-site assessment and collection of old TV to be conducted after delivery of new TV.
- 3**  Immediately receive your trade-in value via bank transfer.

Immediate valuation prices are indicative only, and are subjected to change after assessment by trade-in partner on-site. Visit <https://www.samsung.com/sg/tvtradein/> for more details.

A full spectrum of support

Choose QLED for peace of mind

- | | | | | | |
|---|--|---|---|--|--|
|  <p>10 years' burn-in-free warranty¹⁸</p> |  <p>7 days' in-home servicing</p> |  <p>3 years' warranty³²</p> |  <p>24/7 hotline for service enquiries</p> |  <p>Immediate troubleshooting via remote access</p> |  <p>Real-time Samsung service tracker with engineer location visibility</p> |
|---|--|---|---|--|--|



This is burn-in!

A permanent image left on-screen due to prolonged display, which QLED is guaranteed against¹⁸. Ask for a demo now.

Other TV brands.

TV and soundbar in perfect harmony



Purchase with Purchase
\$300 Shopping Voucher*
with purchase of selected Samsung TVs



HW-Q950T

Dolby Atmos **dts**

True Dolby Atmos® & DTS:X™
 Indulge in True Cinematic Sound with 9.1.4ch

Multi-dimensional sound
 Feel the surround and overhead sound with 20 front, up, side and rear-firing speakers

Q-Symphony³³
 Sound from TV and soundbar synchronise to elevate surround sound

Tap Sound³⁴
 Tap your phone on the soundbar to enjoy whatever you're listening to with incredible soundbar audio

Purchase with Purchase
\$300 Shopping Voucher*
with purchase of selected Samsung TVs



HW-Q900T

Dolby Atmos **dts**

True Dolby Atmos® & DTS:X™
 Indulge in True Cinematic Sound with 7.1.2ch

Multi-dimensional sound
 Feel the surround and overhead sound with 16 front, up, and side-firing speakers

Q-Symphony³³
 Sound from TV and soundbar synchronise to elevate surround sound

Tap Sound³⁴
 Tap your phone on the soundbar to enjoy whatever you're listening to with incredible soundbar audio

Purchase with Purchase
\$200 Shopping Voucher*
with purchase of selected Samsung TVs

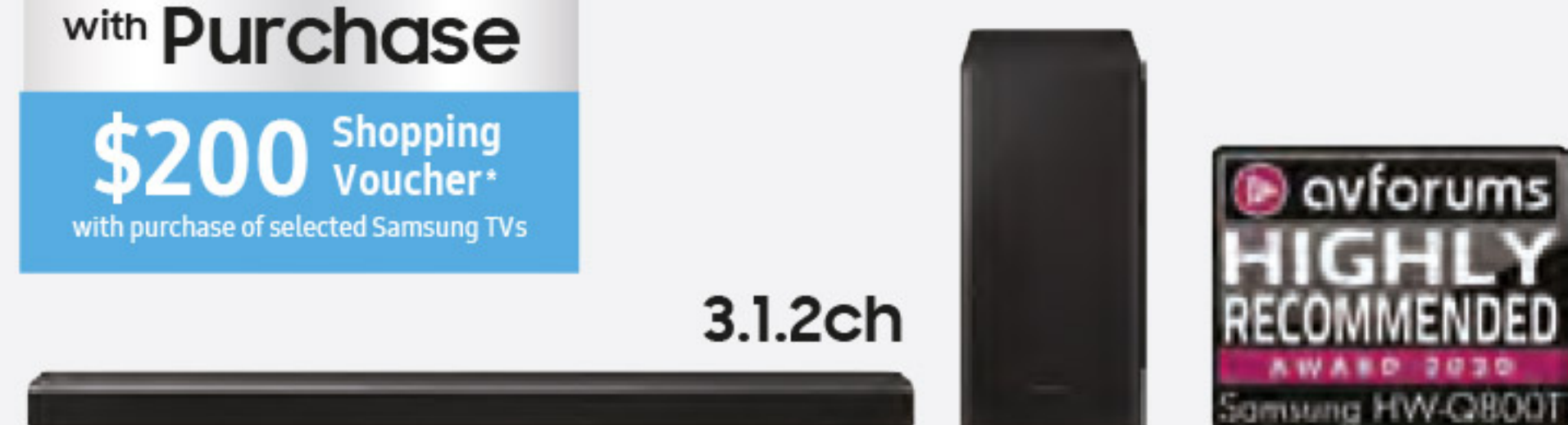

HW-Q800T

Dolby Atmos **dts**

True Dolby Atmos® & DTS:X™
 Indulge in True Cinematic Sound with 3.1.2ch

Multi-dimensional sound
 8 speakers to recreate surround sound with up-firing speakers

Q-Symphony³³
 Sound from TV and soundbar synchronise to elevate surround sound

Powerful 8" Subwoofer
 Up your adrenaline with powerful and deep bass

Purchase with Purchase
\$150 Shopping Voucher*
with purchase of selected Samsung TVs

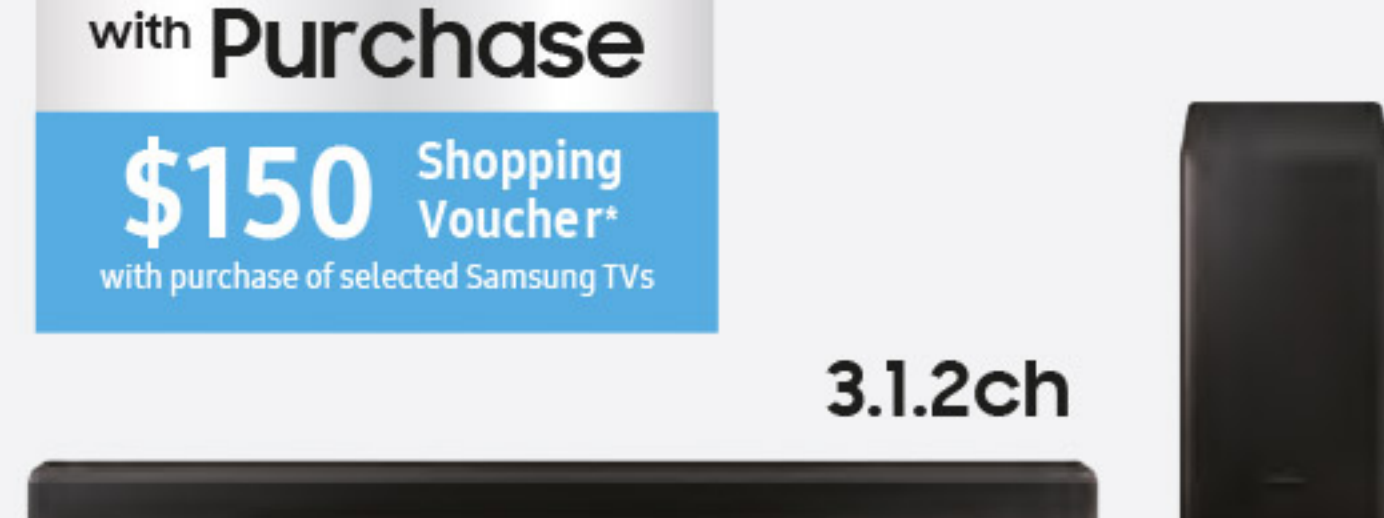

HW-Q70T

Dolby Atmos **dts**

True Dolby Atmos® & DTS:X™
 Indulge in True Cinematic Sound with 3.1.2ch

Multi-dimensional sound
 8 speakers to recreate surround sound with up-firing speakers

Q-Symphony³³
 Sound from TV and soundbar synchronise to elevate surround sound

FREE*
\$150 Shopping Voucher

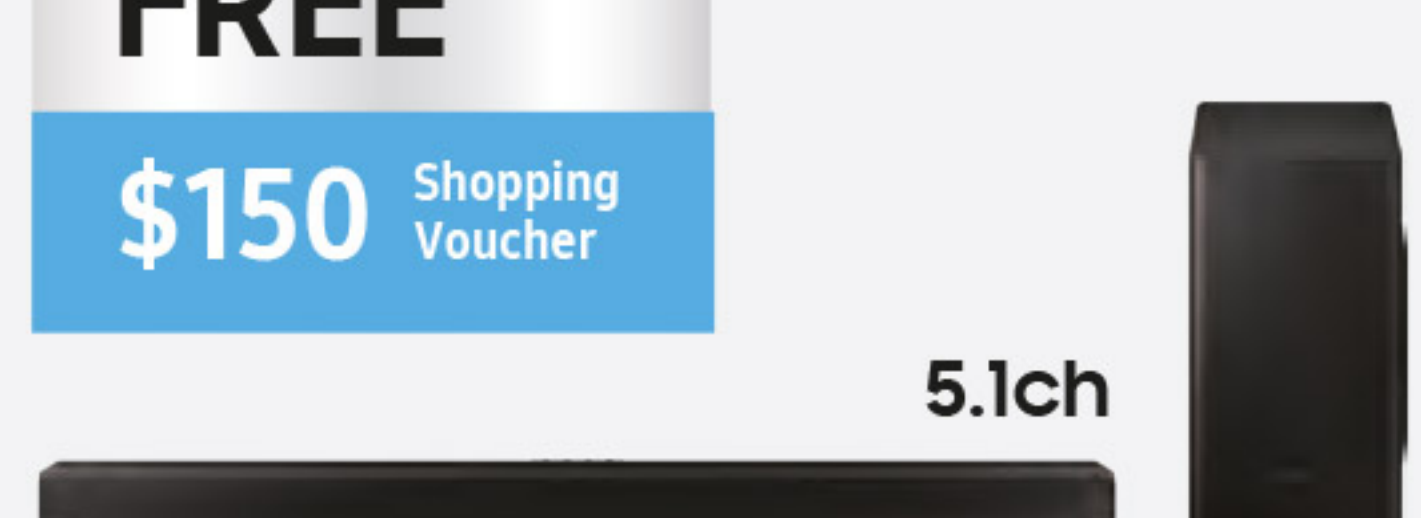

HW-Q60T

Samsung Acoustic Beam Technology
 Delivers the ultimate panoramic sound with 5.1ch

Voice and tone clarity
 Dedicated centre speaker for crystal clear dialogue

Q-Symphony³³
 Sound from TV and soundbar synchronise to elevate surround sound

S series soundbar



A soundbar that looks as good as it sounds

FREE*

\$150 Shopping Voucher



4.0ch

HW-S61T ●
HW-S60T ●

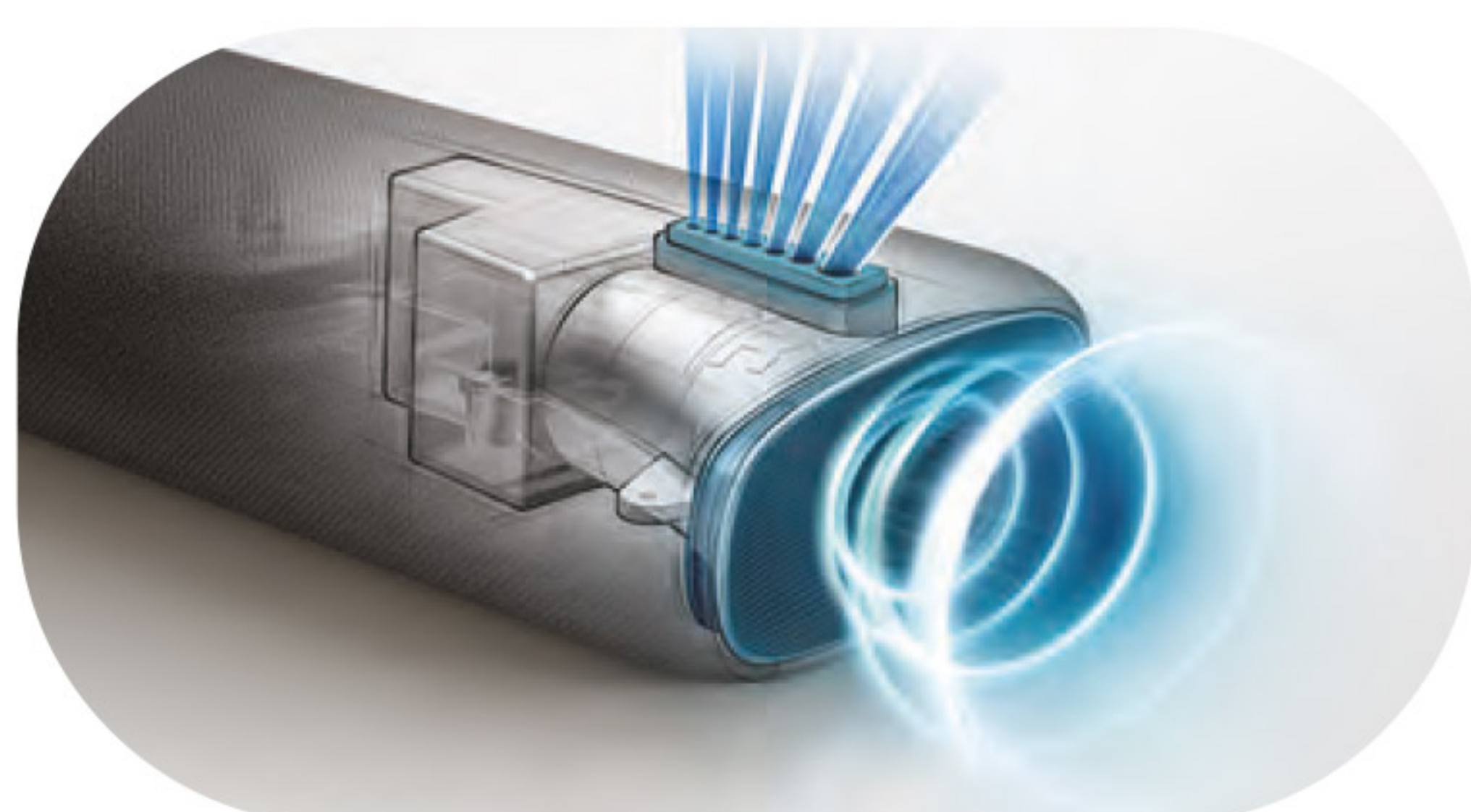

Experience room-filling sound
Samsung Acoustic Beam technology with two side horn speakers



Premium Kvadrat Textile
Add a touch of class to your home interior with premium finishing



All-in-one Soundbar
Stylish and compact design, suitable for use in any space

T series soundbar



HW-T650

3D Surround Sound
3.1ch sound that envelops you

Voice and tone clarity
Dedicated centre speaker for crystal clear dialogue

Game Mode
Win more games with highly directional sound

Purchase with Purchase

\$50 Shopping Voucher*
with purchase of selected Samsung TVs

3.1ch

HW-T550

Purchase with Purchase
\$50 Shopping Voucher*
with purchase of selected Samsung TVs

2.1ch



Game Mode
Win more games with highly directional sound

Powerful Bass
Deep rich bass with a wireless subwoofer

Wireless TV Connection
No more messy wires. Connect to your Samsung TV with Bluetooth® TV connection

HW-T450



2.1ch

Powerful Bass
Deep rich bass with a wireless subwoofer

Wireless TV connection
No more messy wires. Connect to your Samsung TV with Bluetooth® TV connection

One Master Remote Control³⁵
Manage key soundbar functions such as power, volume and sound effects from just a single remote control

TV dimensions

Model	Size (inch)	With Stand		Without Stand	
		Dimension (w x h x d)	Weight	Dimension (w x h x d)	Weight
Q950T	85	1877.0 x 1131.3 x 340.1 mm	65.8 kg	1877.0 x 1066.4 x 15.2 mm	51.8 kg
Q950T	75	1654.8 x 1009.9 x 307.4 mm	44.0 kg	1654.8 x 940.1 x 15.0 mm	34.4 kg
Q950T	65	1433.1 x 881.1 x 261.9 mm	31.5 kg	1433.1 x 814.3 x 15.0 mm	25.9 kg
Q800T	82	1830.2 x 1144.0 x 365.1 mm	54.2 kg	1830.2 x 1049.5 x 25.7 mm	41.5 kg
Q800T	75	1672.5 x 1054.3 x 317.5 mm	43.8 kg	1672.5 x 958.0 x 25.4 mm	34.3 kg
Q800T	65	1447.9 x 921.1 x 285.3 mm	31.0 kg	1447.9 x 830.9 x 25.2 mm	24.0 kg
Q95T	75	1670.6 x 1048.7 x 317.9 mm	48.1 kg	1670.6 x 957.8 x 35.2 mm	38.1 kg
Q95T	65	1446.5 x 919.3 x 285.7 mm	33.1 kg	1446.5 x 828.3 x 34.8 mm	26.2 kg
Q95T	55	1227.6 x 794.8 x 235.6 mm	24.1 kg	1227.6 x 705.6 x 34.8 mm	19.8 kg
Q80T	65	1446.5 x 905.7 x 289.1 mm	27.8 kg	1446.5 x 829.8 x 53.9 mm	24.1 kg
Q80T	55	1227.6 x 783.4 x 255.8 mm	21.0 kg	1227.6 x 706.7 x 53.9 mm	17.9 kg
Q70T	85	1896.3 x 1186.4 x 392.1 mm	48.7 kg	1896.3 x 1082.5 x 59.9 mm	47.5 kg
Q70T	75	1675.4 x 1040.6 x 323.0 mm	39.5 kg	1675.4 x 959.6 x 60.4 mm	36.0 kg
Q70T	65	1449.6 x 911.9 x 307.2 mm	24.8 kg	1449.6 x 829.3 x 57.6 mm	22.3 kg
Q70T	55	1230.1 x 788.8 x 264.1 mm	19.2 kg	1230.1 x 705.9 x 57.4 mm	17.2 kg
Q60T	75	1675.4 x 1049.4 x 352.3 mm	36.3 kg	1675.4 x 959.6 x 60.4 mm	36.0 kg
Q60T	65	1449.6 x 907.7 x 289.1 mm	22.6 kg	1449.6 x 829.3 x 57.6 mm	22.3 kg
Q60T	55	1230.1 x 783.7 x 243.3 mm	17.4 kg	1230.1 x 705.9 x 57.4 mm	17.2 kg
Q60T	50	1116.4 x 720.5 x 243.3 mm	13.1 kg	1116.4 x 642.9 x 57.1 mm	12.9 kg
Q60T	43	963.5 x 629.4 x 195.2 mm	9.2 kg	963.5 x 557.7 x 56.8 mm	9.0 kg
TU8000	82	1829.9 x 1148.2 x 392.2 mm	38.9 kg	1829.9 x 1045.0 x 59.9 mm	37.7 kg
TU8000	65	1449.4 x 906.6 x 282.1 mm	20.9 kg	1449.4 x 830.3 x 59.9 mm	20.6 kg
TU8000	55	1230.5 x 783.3 x 250.2 mm	14.2 kg	1230.5 x 707.2 x 59.9 mm	13.9 kg
TU8000	50	1116.8 x 719.1 x 250.2 mm	11.6 kg	1116.8 x 644.2 x 59.9 mm	11.4 kg
TU8000	43	963.9 x 627.8 x 192.5 mm	8.3 kg	963.9 x 558.9 x 59.6 mm	8.1 kg
TU7000	75	1673.2 x 1043.0 x 339.9 mm	30.8 kg	1673.2 x 958.2 x 59.9 mm	30.4 kg
TU7000	65	1449.4 x 905.2 x 283.5 mm	20.9 kg	1449.4 x 830.3 x 59.9 mm	20.6 kg
TU7000	55	1230.5 x 778.3 x 249.7 mm	14.2 kg	1230.5 x 707.2 x 59.9 mm	13.9 kg
TU7000	50	1116.8 x 713.6 x 249.7 mm	11.6 kg	1116.8 x 644.2 x 59.9 mm	11.4 kg
TU7000	43	963.9 x 628.9 x 200.5 mm	8.3 kg	963.9 x 558.9 x 59.6 mm	8.1 kg
LS03	75	1679.6 x 1005.1 x 304.9 mm	39.2 kg	1679.6 x 957.7 x 49.9 mm	38.8 kg
LS03	65	1453.9 x 876.5 x 290.8 mm	25.5 kg	1453.9 x 829.4 x 45.8 mm	25.2 kg
LS03	55	1235.0 x 753.4 x 213.9 mm	19.4 kg	1235.0 x 706.3 x 45.8 mm	19.2 kg
LS01	55	1254.9 x 1237.4 x 482.8 mm	27.6 kg	1254.9 x 748.3 x 221 mm	26.5 kg
LS01	43	986.3 x 1028.4 x 417.2 mm	17.6 kg	986.3 x 597.3 x 197.0 mm	16.6 kg
LS05	43	564.7 x 1200.0 x 327.0 mm	33.3 kg	564.7 x 1228.1 x 83.4 mm	26.0 kg

Soundbar dimensions

Model	Main Speaker Size (w x h x d)	Main Speaker Weight	Subwoofer Size (w x h x d)	Subwoofer Weight
HW-Q950T	1232.0 x 69.5 x 138.0 mm	7.1 kg	210.0 x 403.0 x 403.0 mm	9.8 kg
HW-Q900T	1232.0 x 69.5 x 138.0 mm	7.1 kg	210.0 x 403.0 x 403.0 mm	9.8 kg
HW-Q800T	980.0 x 60.0 x 115.0 mm	3.6 kg	205.0 x 403.0 x 403.0 mm	9.8 kg
HW-Q70T	980.0 x 60.0 x 115.0 mm	3.6 kg	205.0 x 353.0 x 303.0 mm	6.2 kg
HW-Q60T	980.0 x 58.0 x 105.0 mm	3.4 kg	205.0 x 353.0 x 303.0 mm	6.2 kg
HW-S61T	764.0 x 68.0 x 125.0 mm	2.9 kg	-	-
HW-S60T	764.0 x 68.0 x 125.0 mm	2.9 kg	-	-
HW-T650	980.0 x 58.0 x 90.0 mm	2.4 kg	205.0 x 353.0 x 303.0 mm	6.2 kg
HW-T550	860.0 x 55.0 x 85.0 mm	2.1 kg	200.6 x 353.0 x 290.0 mm	5.0 kg
HW-T450	860.0 x 54.0 x 74.0 mm	1.5 kg	181.5 x 343.0 x 272.0 mm	4.3 kg



TV size	Recommended Soundbars
55" and above TV	HW-Q950T/HW-Q900T Dolby Atmos ⁴ Soundbar
	HW-Q800T/HW-Q70T Dolby Atmos ⁴ Soundbar
49" and above TV	HW-Q60T Samsung Acoustic Soundbar
	HW-T650 Gaming and Powerful Bass Soundbar
43" and above TV	HW-T550 Powerful Bass Soundbar
	HW-S61/HW-S60 Lifestyle Soundbar
32" and above TV	HW-T450 Minimalist Soundbar

Promotion Period:
27 February - 31 March 2021

Redemption Period:
08 March - 31 May 2021

Terms and Conditions: *Promotion is only valid for customers who purchase selected Samsung products as specified herein during the promotion period, and is subject to stock availability. Promotion is not valid with other discounts or promotions. Free gift(s) may only be redeemed on Samsung's redemption site. Check in store for more information. Redemption terms and conditions apply. No extension of redemption period will be allowed. Gift(s) are while stocks last. Payment must be made in full or hire purchase approved before redemption is allowed. Samsung reserves the right to replace any gift with an item of a similar or other value. Gift(s) are not exchangeable for cash or kind. Samsung will not be liable for any lost, damaged or stolen redemption form(s) and gift(s). Promotion is applicable to end-consumers only; not trade, corporate, or bulk purchase. Each customer can redeem gifts for a maximum of 3 product purchases. Samsung reserves the right to reject any redemption that is not submitted with the redemption documents or in accordance with these terms. Products purchased under promotion are not eligible for exchange and/or refund, save in accordance with warranty terms. Samsung reserves the right to amend these terms and conditions without prior notice. Information is accurate at time of print.

¹Source: Omdia, Jan 2020. Ranking in terms of shipments. Results are not an endorsement of Samsung. Any reliance on these results is at the third party's own risk. ²Based on third party independent data. ³Global No.1 Soundbar Sales. Applied years (2014 - 2019) ©2020 Futuresource Consulting. ⁴QLED TVs have received verification from world-class testing and certification association, Verband Deutscher Elektrotechniker (VDE), for its ability to produce 100% colour volume. 100% colour volume measured to DCI-P3 Standard. ⁵Real 8K Resolution is defined as having 7,680 x 4,320 pixels. Native 8K content based on current 8K streaming, connectivity and decoding standard. Future and certain party standards not guaranteed or may require additional device/adaptor purchase. ⁶Viewing experience may vary according to types of content and format. 'AI Upscaling' may not apply to PC connection, and certain conditions of Game Mode. ⁷Direct Full Array numerical index is an internal standard based on backlighting, anti-reflection and contrast enhancement technologies. ⁸The range of Quantum HDR claims luminance based on internal testing standards and is subject to change according to viewing environment or specific conditions. ⁹The 'One Invisible Connection' refers to a single, transparent optical cable connected to the One Connect Box including the TV power integrating external device cables, but it does not refer to cables connected to other devices such as a soundbar. ¹⁰Subject to device compatibility. Devices must be connected to One Connect Box via HDMI cable. ¹¹Minimal gap measured from rear end of the TV, the gap may differ based on the installation and wall type. No Gap Wall-Mount sold separately. ¹²Subject to device compatibility ¹³Bixby service availability requires Samsung Account login and data connection. Available functions and features may vary by country, region, and language. ¹⁴Tap view is available on Samsung Galaxy Devices with Android OS 8.1 and higher. This service only works with the mobile when the screen is turned on. ¹⁵Subject to device compatibility. ¹⁶The Magic Screen background setting feature may vary depending on the environment where the TV is installed including, but not limited to, wall designs, patterns, and/or colours. ¹⁷Samsung TV Concierge Service is only valid for customers who purchase any QLED 8K between 3 November 2020 - 31 March 2021. Delivery, set-up and installation services are subject to slot availability. All wall-mount installation requests are subject to on-site inspection and determination of the suitability of the wall for mounting. Notwithstanding installer's inspection of the wall, cracks may appear on certain wall types after wall-mounting, and neither Samsung nor the installer will be liable for any cracks on wall after wall-mounting. For wall-mount installation, one set of Wall-Bracket will be provided. Terms and conditions apply. ¹⁸Warranty is limited to burn-in that occurs in QLED TVs under conventional TV viewing conditions and does not cover burn-in that occurs in QLED TVs that are used for business purposes. ¹⁹Eye-safety certification: 65Q900T, 65Q90T, 65Q60T. ²⁰Requires installation of SmartThings app on compatible mobile device. Each device must be connected to Wi-Fi[®] or other wireless network. Subject to device compatibility. For interoperability through SmartThings, all the devices should be registered with a single Samsung Account. ²¹Complimentary 4 Months Art Store Subscription can be redeemed via Samsung promotion app. Terms and conditions apply. ²²Some art may require purchase or paid subscription with the Art Store. Art pieces in the Art Store are subject to change without prior notice. Internet connection and Wi-Fi[®] network required. Data and usage charges may apply. ²³When using NFC on TV, Bluetooth[®] on your compatible mobile device will automatically activate. Subject to device compatibility. ²⁴The Sero Wheel is sold separately. ²⁵Customisable Bezels are sold separately. ²⁶The peak brightness may vary depending on the model and size of the TV. The HDR10+ certification may vary by model and is only available for HDR10+ content. ²⁷SmartThings camera is required and sold separately. ²⁸Available for all 2020 Smart UHD TV models. ²⁹Subject to device compatibility. ³⁰Subscription charges may apply. ³¹Available on 2019 and 2020 Samsung Smart UHD TVs. ³²Warranty terms and conditions apply. ³³Q-Symphony is compatible with selected 2020 TV models inclusive of Q950T, Q800T, Q95T and Q80T (excluding 49"Q80T). TV sold separately. ³⁴Tap Sound works through Bluetooth[®], and is compatible with Samsung mobile devices with Android 8.1 and above. ³⁵One Master Remote Control comes with selected Samsung TV models. Function and remote control design may vary by TV model and region. Please check the Samsung TV's specification.

All images shown are for illustrative purposes only. Apple and AirPlay 2 are trademarks of Apple Inc, registered in the U.S. and other countries. Dolby and Dolby Atmos are trademarks of Dolby Laboratories. All other company, product and service names, trademarks, registered trademarks and service marks are the property of their respective owners.

For more information, please visit samsung.com/sg