

SAMSUNG

Technical White Paper

Massive MIMO for New Radio

December 2020

Contents

01 Introduction

02 Overview of Massive MIMO

- What is Massive MIMO?
- Benefits of 'Massive' Antennas
- 2D Active Antenna System
- Form Factor of Massive MIMO

07 Air Technologies for Massive MIMO

- SRS-based Single User MIMO
- PMI-based Single User MIMO
- Beamformed CSI-RS
- Downlink Multi-User MIMO
- Performance Comparison by Simulation

17 Samsung's View on Massive MIMO

- Hardware Plan for Massive MIMO
- Software Plan for Massive MIMO

19 Summary

19 References

Introduction

5G new radio (NR) is conceived to provide new service types, namely, enhanced mobile broadband (eMBB), ultra-reliable and low latency communications (URLLC), and massive machine-type communications (mMTC). Among these, eMBB is expected to provide exceptionally fast data speeds to facilitate services that have high throughput requirements such as high definition (HD) video streaming, virtual reality (VR), and augmented reality (AR). The goal of eMBB is not just to serve faster transmission speeds when a user is near a base station, but also to deliver unparalleled end-user experiences in crowded areas such as airports or sport stadiums, thus allowing users to enjoy seamless high-quality streaming services, regardless of their locations.

Massive multi-input multi-output (MIMO) is a major breakthrough technology that improves the capacity and user experience of 5G eMBB. Instead of broadcasting data throughout the entire coverage area, the massive MIMO system concentrates the signal energy to a specific user, resulting in significant improvement of throughput and efficiency. This characteristic not only increases the downlink (DL) and uplink (UL) signal strength but also enhances the cell throughput by allocating multiple beams to one or multiple users. The spatially optimized signal can minimize its interference toward other users and/or adjacent cells and reduces interference levels of the entire network, especially in interference limited cell deployments [1-2].

During this time, when 5G RAN equipment is being deployed, massive MIMO technology comes into the limelight for the following reasons:

- Many newly deployed 5G systems operate on higher frequency (TDD) bands than 4G. In order to make up for increased path loss of high frequency and limited coverage of TDD, coverage enhancement techniques are essential for 5G cell deployment.
- According to many recent reports, mobile traffic demand is expected to grow at an explosive rate. Newly deployed 5G equipment should be capable of high system capacity and end-user throughput.
- 5G system does not have many legacy mobiles that limit the gain of advanced MIMO approaches. Hence, state-of-the-art MIMO technologies are easily introduced in 5G systems and can achieve performance improvement.

Scope of this paper

In this paper, we first describe the general principles of transmitting through a large number of antennas in a cellular system. Secondly, we look into massive MIMO radio structures that are fitted to the various deployment environments. Next, we introduce several DL MIMO schemes of 5G system and compare their pros and cons according to channel environment, traffic condition and device capability. Lastly, we present Samsung's massive MIMO radio hardware and software plans for the best 5G MIMO performance. Samsung provides optimized algorithms for a mixture of various UE capabilities, SRS resource limitation, or enhanced antenna configurations.

Overview of Massive MIMO

What is Massive MIMO?

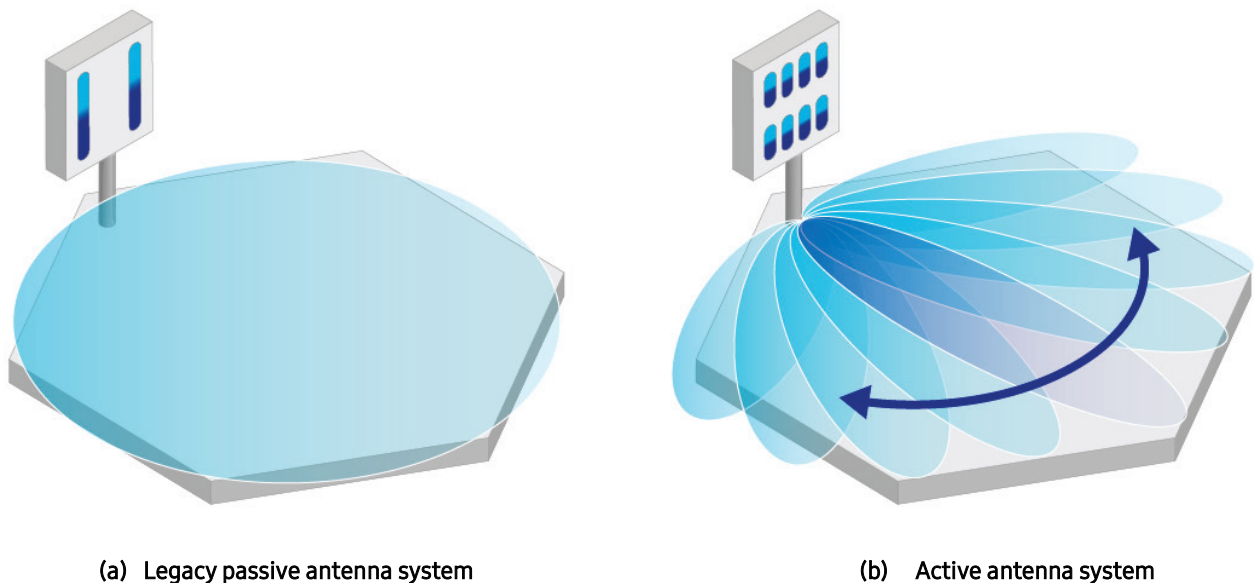

Figure 1. Comparison for beam patterns of cellular systems

The passive antenna beam pattern of legacy cellular systems is fixed and shaped to transmit its signal uniformly within the coverage direction. On the contrary, an active antenna system (AAS) consisting of multiple antenna elements is able to transmit and receive the signal through beams of a narrow beamwidth and high gain as shown in Figure 1. In addition, it can adjust the amplitude and phase of each transmit/receive radio frequency (RF) chain and dynamically control the beam direction toward the location of a desired user.

An AAS with many RF chains brings in a high degree of freedom of beamwidth, beam gain, and beam direction. The system performance and user experience can be improved by the associated technologies, so-called 'massive MIMO.' Strictly speaking, in an academic sense, some researchers claim that the term 'massive MIMO' is inappropriate for point-to-point MIMO solutions, which is not a multi-user (MU-) MIMO [3]. This paper, however, explores the adoption of new massive MIMO radio hardware and introduces various DL MIMO schemes that maximize user experience and compares the expected performances of such adoption.

Benefit of 'Massive' Antennas

With a large number of antennas, a base station can concentrate its transmit power into a form of narrow beams. If the base station can dynamically adjust the phase and amplitude of (groups of) antenna elements, it has the capability to control the shape and direction of its transmitted signals. As a result, the following benefits can be expected in cellular systems:

Coverage enhancement and shaping

- Pin-pointing the focused beam to a particular user located in the cell edge can improve the quality of received DL signal and increase cell coverage. Furthermore, because the signal power is highly focused on the user, it can reduce the level of interference toward other users in the same cell and the adjacent cells.
- In an ideal and simplified cell-layout, such as a system-level simulation (SLS), a cell's shape is expressed as a circle or a hexagonal figure. However, the cell coverage in an actual field environment has various and irregular shapes depending on the surrounding geographical features, distribution of buildings and

obstacles, and the unpredictable distribution of traffic demand and subscribers. Given these circumstances, a cellular system with many antennas is able to change its coverage shape by superposing multiple narrow beams and building the coverage that best fits the cell's unique layout.

Improved single user throughput

- The base station's signal goes to a specific user through a sharp beam generated by multiple antenna elements. As the effective isotropic radiation power (EIRP) increases in proportion to the antenna gain, the signal quality of the user is enhanced by the condensed beam regardless of its cell location. The sharp beam tracks after the user, similar to a focused beam of light created by a searchlight.
- Allocation of multiple beams to different receive antennas of a single user increases the number of layers for single user (SU-) MIMO. The intensified signal power and increased number of layers contribute to better user throughput.

Cell throughput gain by spatial division multiple access

- A base station with multiple antennas can generate multiple beams, which do not interfere with each other. By distributing the beams to different users, it can communicate simultaneously with multiple users through the same time and frequency resources. Because the signal quality of each user is limited by inter-beam interference, the sharper the beam generated by the massive MIMO system, the higher the quality of signal served to the users [4].
- In an environment where multiple users demand for high load of traffic, the method through which a base station communicates with multiple users by spatial division multiple access determines its spectral efficiency and system capacity.

2D Active Antenna System

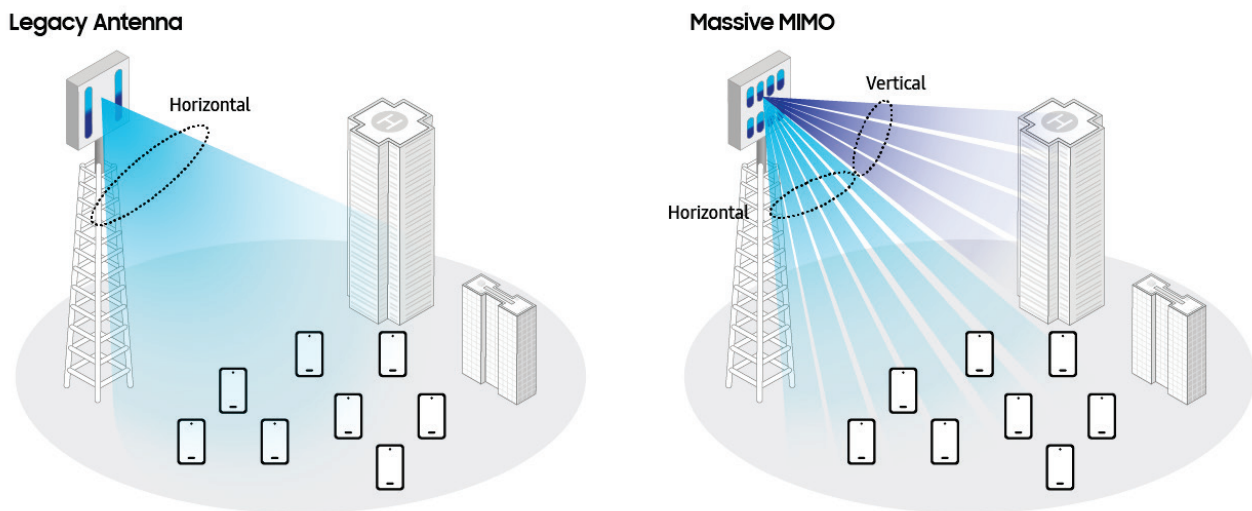

Figure 2. Evolution from passive antenna to 2D active antenna system

An interesting aspect of the massive MIMO system is the active antenna that features a 2D planar array. A benefit that rises from the use of a 2D AAS is the ability to accommodate a large number of antennas without having to increase the deployment space. For example, when a uniform linear array system with 64 antenna elements is deployed on the ground, under the common assumption that the antenna spacing is half the wavelength and that the system is using 3.5 GHz carrier frequency, an installation area of nearly 3 meter is required. Due to the limited space on a rooftop or a mast, this sort of space requirement is hard to come by on

most cell sites. In contrast, if antenna elements are arranged in a 2D array, a much smaller space suffices. For example, if a 2D array has 64 antenna elements arranged in an 8 by 8 square, less than 0.4 meter of height and width is required under the same assumptions mentioned above.

The array pattern generated by 2D planar array sharpens the width and height of a beam, improves the antenna gain further, and is able to control the boresight of beam in both vertical and horizontal directions.

In densely populated environments such as an urban area with high-rise buildings or a stadium holding sporting events, subscribers are spread over various heights in a vertical direction. As shown in Figure 2, 2D planar array is able to generate a user-specific beam according to the azimuth and elevation angles of each user [5].

Form Factor of Massive MIMO

The antenna array in a base station consists of three components as follows:

A pair of dual-polarized antenna elements

In general, an antenna element is comprised of a micro-strip (patch) antenna. When such antenna elements are co-polarized, they are capable of simultaneously transmitting and receiving two mutually orthogonal signals without generating additional array gain. The co-polarization created by the antenna element acts as a pair of well-isolated spatial paths for diversity and spatial multiplexing, without the increase in the size of the antenna.

Subarray

In terms of development cost and cell's angular coverage, it is inefficient to apply independent digital beamforming (BF) to every antenna element. Even under the assumption that one were to operate a 2D AAS using many antenna elements, the azimuth and elevation angles would be limited to a certain range according to the geometric distribution of the users. Moreover, because base station antennas are typically installed on high locations such as a rooftop or a mast, its elevation angle does not need to have the full-range of $-90^\circ \sim 90^\circ$ in the vertical direction which would cause unnecessary transmission power loss.

Hence, just a few adjacent antenna elements (typically in a vertical direction) are arranged into a group and only a single RF transmit/receive chain - including a power amplifier and a low noise amplifier - is connected to the group, which is called a subarray. A subarray in a 32T32R massive MIMO radio, depicted in Figure 3-(a), consists of three antenna elements ($N_{\text{sub}} = 3$). Because only one digital BF weight is applied within a subarray, the adjustment of a subarray's steering angle requires an additional RF element such as a phase shifter.

Array (of subarrays)

A 2D array has multiple subarrays as its array element. Four vertical columns of subarrays and four horizontal rows of subarrays create a 2D array of ($N_V = 4, N_H = 4$). Although a dual polarized pair of antenna elements does not contribute any array gain, it is counted as two horizontal array elements. As a result, the massive MIMO radio's form factor in Figure 3-(a) is called 4 vertical 8 horizontal (4V8H in short). Similarly the form factor in Figure 3-(b) is called 2V16H.

A user-specific beam is transmitted toward the individual receive antenna of the user through a BF weight vector, which is defined as a steering vector toward the user's direction in line-of-sight (LOS) condition or a maximal ratio transmission vector in a non-LOS environment. In the case of LOS, the array gain is equal to the number of subarrays.

Various form factors of massive MIMO radios are defined according to their 2D array structure. Since 64T64R massive MIMO radio with 4V16H has a higher 2D array than that of 32T32R massive MIMO radio, a user-specific beam of 64T64R massive MIMO radio with 4V16H has half width and 3dB higher gain than that of 32T32R massive MIMO radio.

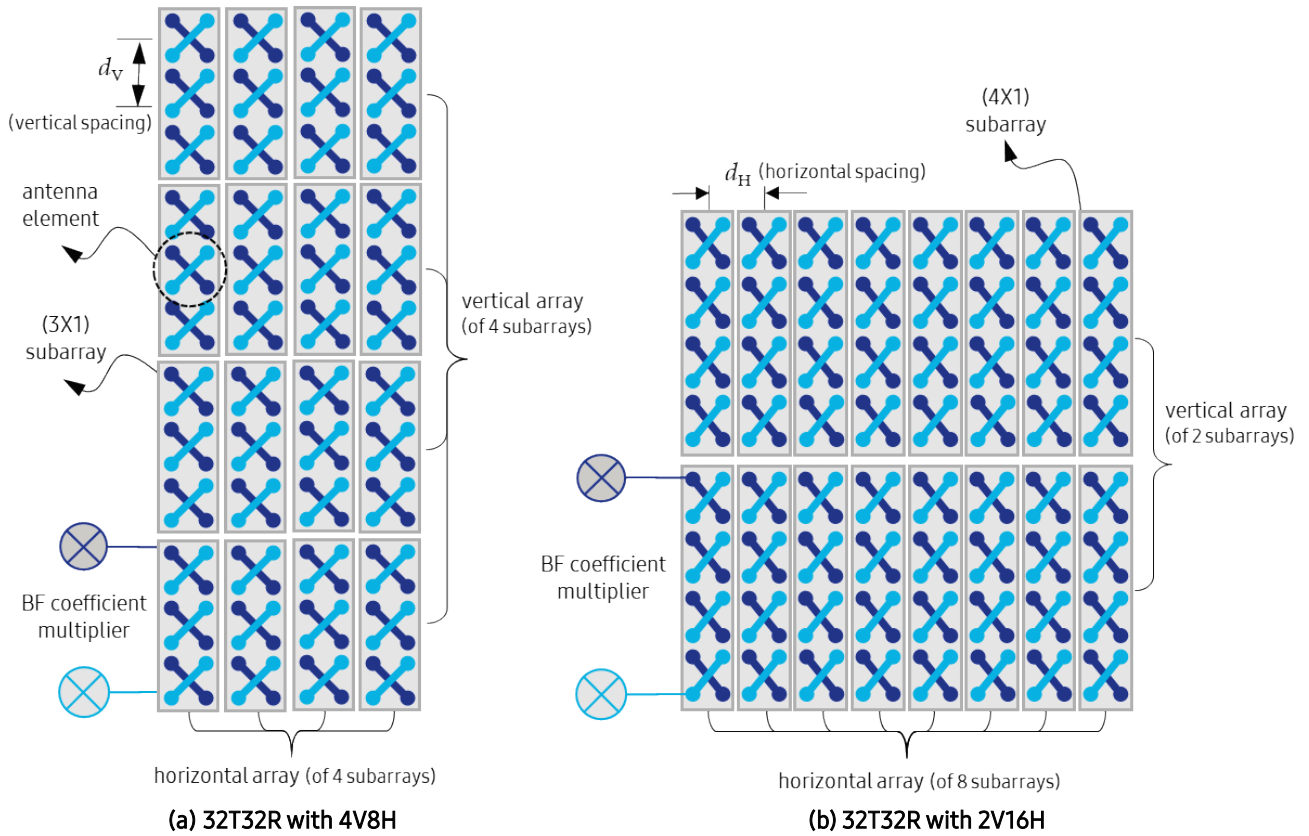

Figure 3. An example of massive MIMO radio configuration (32T32R with 4V8H and 96 antenna elements)

Based on the three array components above, three major characteristics that determine the massive MIMO radio performance are defined as follows. In addition, these three characteristics can be used as criteria to evaluate massive MIMO radios of varying form factors.

User-specific Beam gain

The maximum antenna gain of a user-specific beam is expressed in dB by the sum of its array gain and subarray gain. Array gain is proportional to the number of subarrays in an array (N_V and N_H) and subarray gain is approximately proportional to the number of antenna elements within a subarray (N_{sub}) and the spacing between adjacent antenna elements (d_V and d_H), both of which are assumed to be normalized to the wavelength. The antenna gain (toward the boresight) of the whole antenna system is decided by the antenna aperture of the massive MIMO radio regardless of its form factor.

User-specific Beamwidth

Rather than improving the signal strength of the desired user, a narrower beamwidth causes a smaller interference on other users. Hence, it mainly affects the performance of DL MU-MIMO. The beamwidth is inversely proportional to the length of the massive MIMO antenna in vertical and horizontal directions, respectively.

Vertical Angular coverage

Unless an additional RF device like a phase shifter is added, the subarray pattern does not change dynamically. Therefore, the operational range of vertical steering angle for the massive MIMO radio system is limited to the subarray's beamwidth, which can be referred to as the 'angular coverage' of the massive MIMO radio system. Because a subarray usually has a form of single vertical column, the vertical angular coverage is inversely proportional to the height of the subarray.

Figure 4 demonstrates the concept and relationship of the antenna gain, beam width in vertical direction, and angular coverage. Among the three features, a (vertical) angular coverage has significant influence on the deployment environment where both vertical and horizontal BF gains can be achieved.

Dense urban area: Wide angular coverage is necessary, especially if:

- Cell density is high and inter-site distance is small due to crowded subscribers and high traffic demand in the cell, or
- There are high-rise buildings in the cell coverage area, (although the cell size is very small, the antenna down-tilt limits the coverage of tall buildings. It may even introduce a coverage hole just below the site antenna [6]), or
- The buildings have their own indoor coverage solutions such as repeaters or small cells.

Rural area: Narrow angular coverage is sufficient.

- This type of area usually only holds low-rise apartments, which are widely spread over a broader area. Because the base station antenna is usually mounted on a tall mast or placed on top of a hill, the subscribers' locations are undistinguished in the vertical direction if the base station antenna is properly down-tilted.
- Since there is no high traffic demand, high orders of MU-MIMO gain are not required. Instead of massive MIMO radios, 4T4R or 8T8R antennas with sharp vertical beamwidth might be a better fit in terms of cost.
- In case of fixed wireless access (FWA) where many residential subscribers demand high data-rate services simultaneously, massive MIMO radio can reap the benefit of beamforming and MU-MIMO even in a rural area.

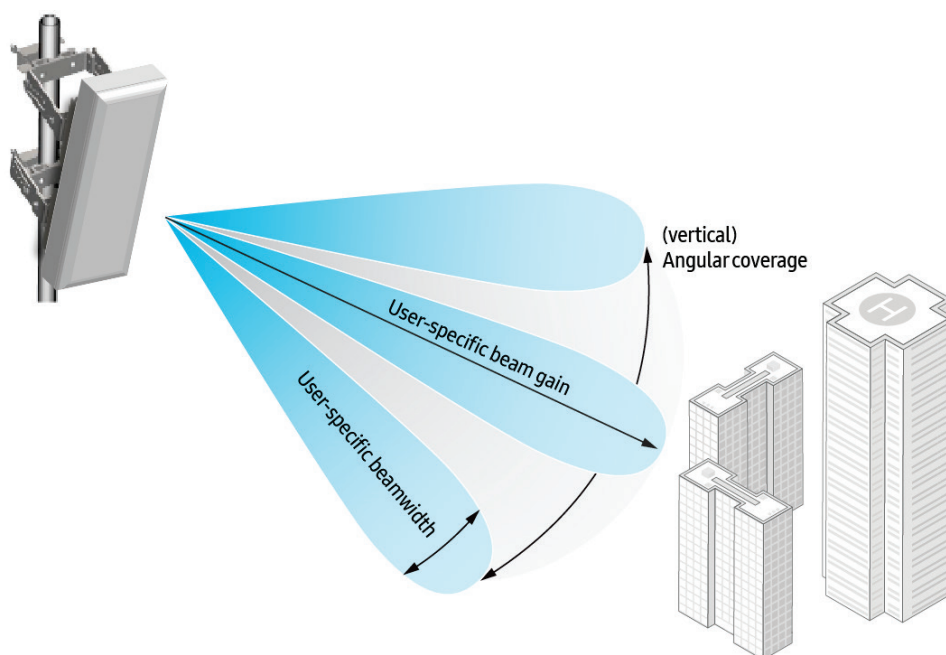

Figure 4. Conceptual plot for vertical beam characteristics

Air Technologies for Massive MIMO

In order to improve the network quality such as cell throughput and coverage, proper MIMO technologies should be provided for the massive MIMO radio hardware. According to the channel state information (CSI) acquisition method, MIMO schemes are categorized into sounding reference signal (SRS)-based SU-MIMO, precoding matrix indicator (PMI)-based SU-MIMO, and beamformed CSI-reference signal (RS) MIMO for low capability devices. The device's capability and radio field condition decide the best MIMO mode. In addition, when multiple users demand for high load traffic simultaneously in a TDD system, DL multi-user (MU)-MIMO solution, which allocates mutually orthogonal beams to the users, is able to enhance the cell throughput and users' experience.

Figure 5 depicts the MIMO channel model between M transmit antennas of massive MIMO base station and N receive antennas of the user device. If M is much larger than N , which is a general condition for massive MIMO, a massive MIMO base station has high degree of freedom of how to pre-code each layer's signal. Hence, the base station can decide the following three parameters to maximize its downlink throughput.

- **The number of layers L :** It is possible to think that a high value of L will lead to the increase in capacity from spatial multiplexing gain. However, since the system's total transmit power is limited, each transmit power per layer is reduced to $1/L$. Furthermore, if the rank of the channel matrix or its auto-correlation matrix is lower than L , the inter-layer interference may cause a throughput loss.
- **(Normalized) precoding vectors:** Mutually orthogonal L vectors are extracted from the composite channel of the precoding and wireless channel. Each layer is allocated with one of the corresponding L precoding vectors. From the base station's perspective, it means that L beams are assigned in a layer-specific way. The precoding vector represents the shape and orientation of the physical beam.
- **Transmit power per layer:** The received channel gain of each layer is not equal even after applying the best (normalized) precoding vector. According to the NR physical layer standard, only one transport block is used to transmit DL/UL data blocks for layers, if $L \leq 4$. In other words, all layers in a DL/UL data block should be transmitted in the same modulation order and channel code-rate. When the gap between received SNRs per layer is high, the received MIMO signal quality is bounded by the layer with the lowest SNR. Hence, adjusting the transmit power of each layer to make the received powers equal; can improve the link performance and throughput.

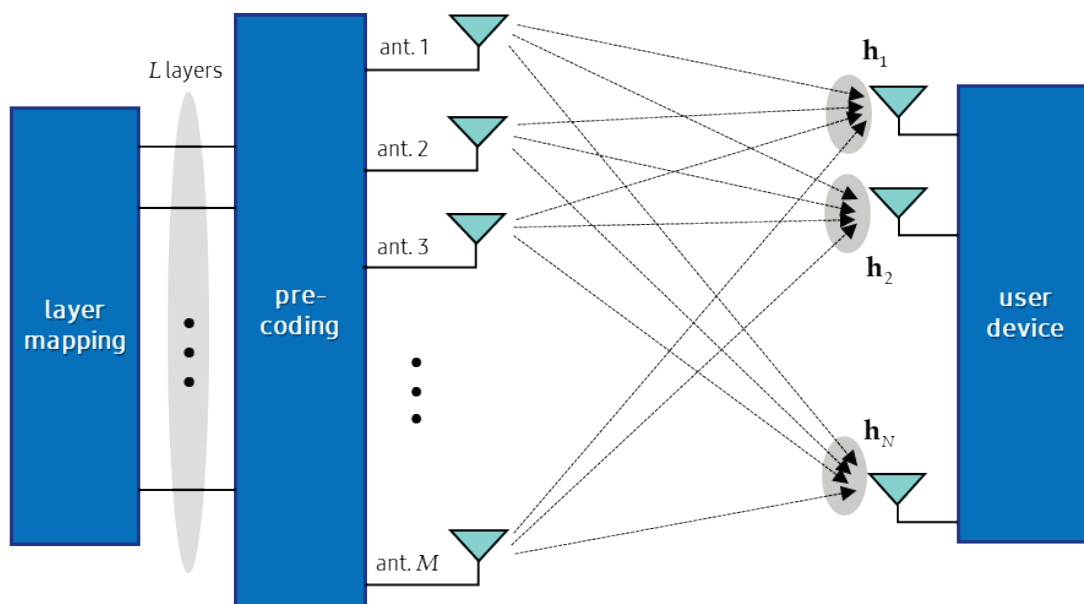

Figure 5. Downlink Channel model for single user MIMO

Based on how the base station acquires the channel state information between transmit antenna ports of massive MIMO system and receive antenna ports of the user device, DL MIMO schemes are classified into SRS-based SU-MIMO, PMI-based SU-MIMO, beamformed CSI-RS, and MU-MIMO.

SRS-based Single User MIMO

In TDD system where the DL and UL channels are considered reciprocal, a base station can calculate DL precoding weights based on the sounding reference signal that a user transmits in UL. In order to obtain the full MIMO channel, channels at N receive antenna should be distinguished and the user device is obligated to transmit SRS for its individual receive antenna.

SRS Transmit Antenna Switching

Although a user's device may have four or eight receive antennas, in general, the number of its uplink transmit antennas is smaller. The reasons are, first, UL transmission is more power-limited than DL transmission and it is more efficient not to increase the number of layers per device in power-limited conditions. Next, adding RF transmit chains to the device may cause several implementation issues such as excessive device power drainage, placement overlaps with cameras and sensors in smart phones, and mobile device radio wave's effect on human body (a.k.a. specific absorption rate [SAR]).

In order to avoid such problems, single transmit RF chain can be connected to one of the receive antennas through a switch when it transmits SRS, as shown in Figure 6. This is called 'SRS transmit antenna switching (TAS)'. A user's device transmits individual SRS for each receive antenna and a base station is able to construct directly a $(M \times N)$ channel matrix from received SRS responses. The base station can decide the best beamforming weight to maximize DL capacity without any quantization error as long as the received quality of SRS is high enough.

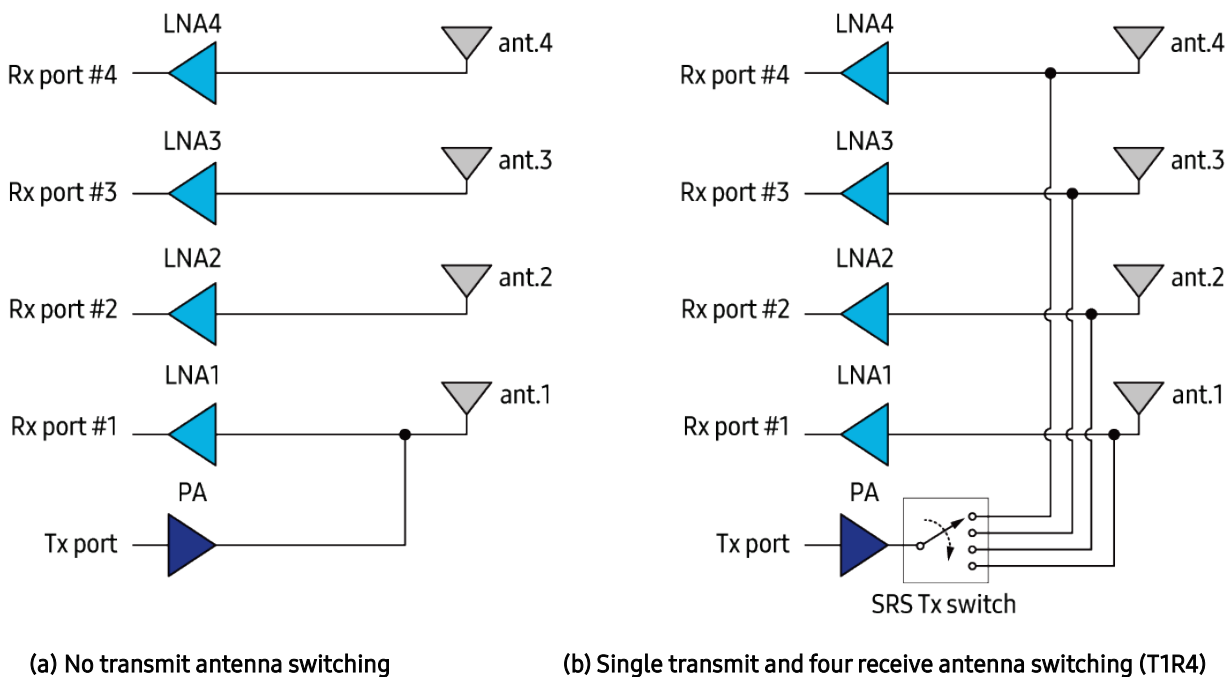

Figure 6. Conceptual diagram of SRS transmit antenna switching

However, since N SRS resources need be allocated per user, the number of users that can be allocated with the required SRS resources is reduced to $1/N$. In addition, because SRS TAS is an optional user capability, SRS-based SU-MIMO cannot be applied to a user device that does not support the optional capability.

(For simple and clear explanation, hereafter, both the number of user receive antenna N and the number of supported DL layers per user L_{MAX} are assumed to be four.)

Beamforming Weight based on SRS

The SRS channel response of the user's n -th antenna is estimated at M antenna ports in the base station. Through a number of mathematical manipulations with $(N \times M)$ MIMO channel matrix, the base station can find the number of layers and each layer's BF vector to maximize DL MIMO capacity.

One of the well-known mathematical operations is a compact singular value decomposition (SVD) of the channel matrix ($\mathbf{H} = \mathbf{U}\mathbf{\Lambda}\mathbf{V}^H$), where \mathbf{U} is an $(N \times N)$ unitary matrix, $\mathbf{\Lambda}$ is a square diagonal of size $(N \times N)$, and $\mathbf{V} = [\mathbf{v}_1, \mathbf{v}_2, \dots, \mathbf{v}_N]$ is a $(N \times M)$ matrix, such that $\mathbf{V}^H\mathbf{V} = \mathbf{I}_N$. Because the l -th diagonal element of $\mathbf{\Lambda}$ represents the l -th layer's channel magnitude, the system can decide the number of layers to maximize its MIMO capacity and choose \mathbf{v}_l , the l -th column vector of \mathbf{V} , as the BF weight for the l -th layer.

Due to the frequency selectivity of wireless channels, the channel response might be diverse at each resource block (RB). Because SRS can be transmitted over the entire bandwidth, each RB can use different BF weights to maximize MIMO capacity. However, since one SVD operation itself requires a very highly complex calculation, executing SVDs for all RBs might not be implementation-friendly in terms of computational load deciding when to apply BF weights to DL transmission. For example, the number of layers should be configured to be same for every RB within a DL/UL data channel although different L per RB is estimated through SVD. In a DL SU-MIMO with a massive MIMO system where the number of base station's antenna M is much greater than the number of user's antenna N , other suboptimal approaches which are much simpler than SVD can also provide the number of layers and the BF weights for each layer and each RB.

PMI-based Single User MIMO

Another method of DL SU-MIMO is for a user to report a set of CSI measurement results consisting of channel quality indicator (CQI), PMI, and rank indicator (RI) to the base station. In this method, the user device continuously monitors a set of M port reference signals at every receive antennas and constructs $(N \times M)$ MIMO channel matrix. Out of the given precoding matrix candidates, it selects the best precoding matrix which is best fitted to the MIMO channel and feedbacks the corresponding PMI through UL [7-9].

CSI reporting based on 32 port CSI-RS

In NR physical layer, contrary to LTE, which constantly transmits common cell-specific RS, CSI-RS is transmitted for user's channel state measurement in a periodic or aperiodic way. The base station is obligated to provide M CSI-RS ports so that the user can observe the full MIMO channel matrix.

NR physical layer defines (type I) PMI codebooks considering various forms of 2D antenna arrays. Figure 7 shows an example for how a group of 2D PMI vectors are generated assuming for a 2D array of $N_H (= 4)$ subarrays in the horizontal direction and $N_V (= 4)$ in the vertical direction. Based on the fact that the precoding weight pointing to a specific direction has a form of a DFT vector, candidate precoding matrices consist of orthogonal (N_H, N_V) digital Fourier transform (DFT) vectors in both directions and their (O_H, O_V) oversampled DFT vectors. The PMI codebook includes the oversampled DFT vectors and co-phasing between polarizations.

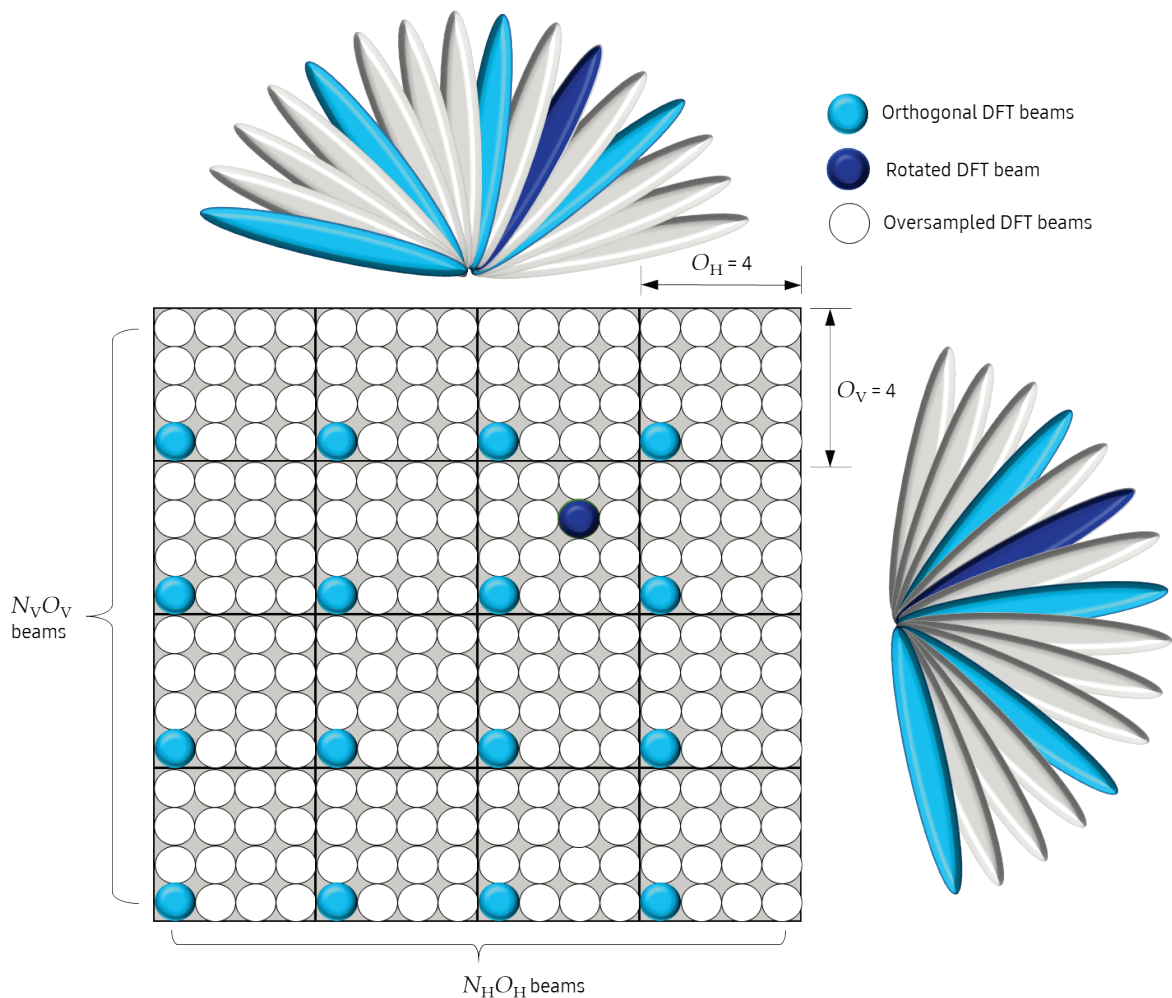

Figure 7. An example of rotated orthogonal beams expressed as oversampled DFT beams for 32 port CSI

Regardless of how the user-dedicated DL signal is pre-coded, the user is able to monitor consistently the given pattern of CSI-RS and thus reports other useful CSI such as RI and CQI along with PMI. As a result, the link adaptation is less sensitive to channel fading and signal strength change caused by user's mobility and relatively stable DL throughput can be achieved.

Comparison between SRS-based and PMI-based SU-MIMO

The signaling exchange procedures for SRS-based SU-MIMO using T1R4 SRS TAS and PMI-based SU-MIMO are depicted in Figure 8. In TDD system, SRS-based precoding has a couple of advantages over PMI-based precoding: First, the base station transmitter is able to acquire CSI without quantization error. Next, it is robust to channel frequency selectivity because each RB's BF weight can be calculated independently based on the SRS response. In order to achieve sufficient gain in commercial fields, however, the following technical challenges should be addressed:

- The number of available SRS resources in a cell is usually much smaller than the maximum number of RRC connected users in the cell. Thus, the system should choose carefully which users are to be allocated with the limited SRS resources. For example, if the number of SRS resources that the system can simultaneously configure is 128, only 32 users can be allocated with T1R4 TAS SRS resources regardless of the number of users communicating with the base station. Therefore, it is very important to build and operate a SRS allocation strategy that selects users who have most to gain from SRS-based precoding and where high DL traffic transmission is expected.

- In contrary to SRS, CSI feedback including PMI has a high degree of freedom when it comes to reducing its feedback overhead by specifying only essential information such as wideband PMI. In general, CSI feedback can be configured simultaneously to much more users than in SRS.
- The signal quality of SRS is easily contaminated by UL transmit power shortage at the cell's coverage edge. Because SRS channel response should be estimated individually at M base station antennas, unlike other uplink data/control channels, its receive performance cannot be recovered by antenna combining or error-correction code. If the user is located in the cell's coverage edge and the estimated SRS channel response is not accurate enough, the gain of SRS-based precoding is degraded accordingly.
- On the other hand, although poor receive quality of DL CSI-RS at cell edge might lower the accuracy of CSI measurement; the CSI feedback is transmitted without alteration and received in UL under the protection of channel coding and diversity gain.

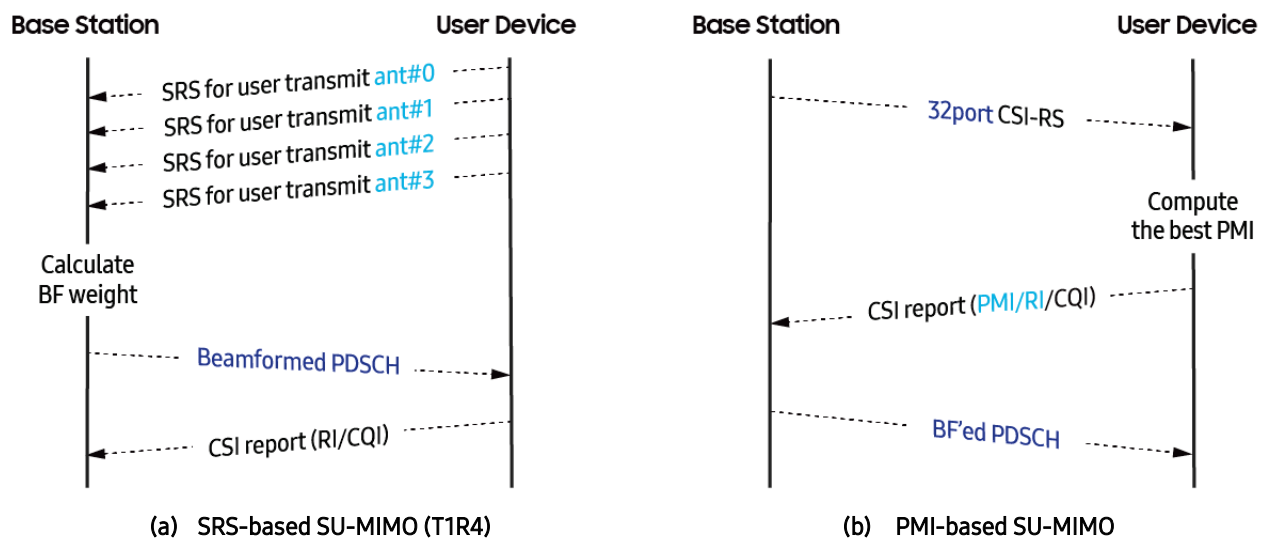

Figure 8. Comparison of signal exchange procedures for different DL MIMO modes

PMI-based DL SU-MIMO can be used in FDD, whereas SRS-based SU-MIMO is only available in TDD where channel reciprocity between DL and UL is guaranteed. The comparison between SRS-based and PMI-based SU-MIMO is summarized in Table 1.

Table 1. Summary of comparison between SRS-based and PMI-based SU-MIMO

Category	SRS-based SU-MIMO	PMI-based SU-MIMO
User capability	SRS transmit antenna switching (higher than T1R4)	CSI reporting on 32 port PMI
Associated resource overhead	Four SRS resources per users in UL	32 port CSI-RS in DL, CSI feedback overhead in UL
CSI quantization error	None	Relatively high
Coverage	Low	High
Supported duplex mode	TDD only	Both of TDD and FDD

SU-MIMO based on Beamformed CSI-RS

To enable one of the two SU-MIMO schemes mentioned above, the following device capabilities are necessary: 1T4R SRS TAS for up to four layer SRS-based SU-MIMO and 32 port PMI reporting capability for PMI-based SU-MIMO in massive MIMO, respectively. As of early 2020, some NR chipsets/devices that have been released in the initial stage of 5G NR commercialization do not support either capability options. In addition, the low-cost NR devices that are being introduced to the market are expected to support only the mandatory capabilities, including features for DL SU-MIMO. For these devices, the number of DL antenna ports for CSI measurement is limited to ≤ 8 . In such, the system needs to provide an alternative scheme where CSI of (32 X 4) MIMO channel can be captured based on four or eight port CSI-RS. To do so, the following two options may be considered:

- **Multiple CSI-RS resources:** The 32T32R system transmits four resources of eight port CSI-RS or eight resources of four port CSI-RS, which are beamformed to be mutually (semi-) orthogonal. Each CSI-RS resource is identified by a CSI-RS resource indicator (CRI). The user is expected to report the CRI of its best preferred CSI-RS resource along with other CSIs such as CQI, PMI, and RI, which are measured from the CSI-RS.
- **UE-specific beamformed CSI-RS:** The method mentioned above is not a user mandatory feature and some commercial devices do not offer this capability. For such devices, the system configures a (non-TAS) SRS resource to the user and estimates a decimation weight vector that makes 32 ports into 8 ports from the SRS responses. The weight vector turns a bundle of four ports into a single beamformed port CSI-RS. Hence, the scheme is called, 'beamformed CSI-RS.' Because the dedicated beamformed CSI-RS shall be configured to each user (or a group of users), this results in a considerable amount of resource overhead.

Both schemes decimate 32 ports into a possible subset of four or eight ports CSI-RS. The user is able to choose the best PMI and RI only within one of the down-selected CSI-RS resources. When the schemes are compared to a full 32 port CSI-RS, they have a limitation in that PMIs belonging to different CSI-RS resources cannot be jointly reported to increase the number of layers. Figure 9 shows the procedure for both SU-MIMO operations using eight port CSI-RS.

Since the maximum number of CSI-RS ports is limited to 32 according to NR physical layer standards, when the number of base station's transmit antennas is greater than 32 (e.g. 64T64R massive MIMO radio), it is inevitable to pre-process them into 32 port CSI-RS regardless of user capability.

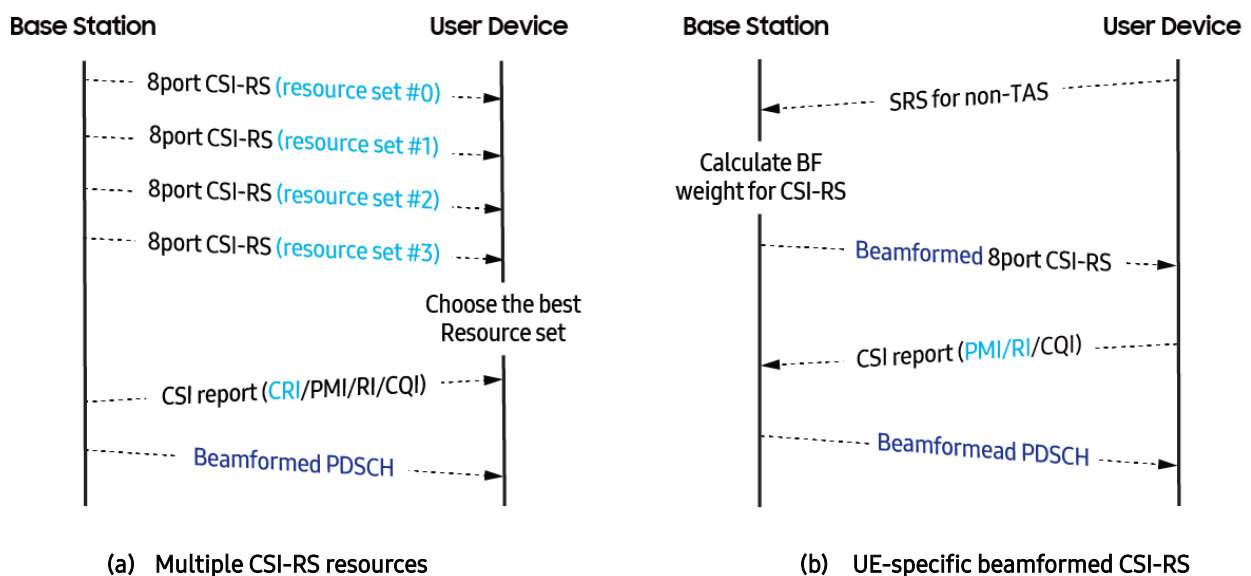

Figure 9. Comparison of signal exchange procedures for SU-MIMO based on beamformed 8 port CSI-RS

Downlink Multi-User MIMO

When the system needs to simultaneously provide multiple users with high DL traffic load services such as video streaming, its spectral efficiency and cell throughput can be increased by spatial division multiple access (or equivalently DL MU-MIMO) which allocates different sets of beams to the users.

DL MU-MIMO Beamforming

For DL SU-MIMO, the BF weight of each layer is determined from PMI feedback or SRS response in order to allocate multiple layers to the same user. Although the composite beams of DL SU-MIMO layers are not perfectly orthogonal to each other, all the layer signals are delivered to single user and the inter-layer interference can be mitigated by advanced receiver techniques.

In the case of DL MU-MIMO, imperfectly orthogonal beams cause multi-user interference and render it difficult for each user's receiver to eliminate the interference. Hence, as shown in Figure 10, the BF weight should be chosen carefully in order to not only maximize the beam gain toward the desired user, but also to minimize its leakage power toward other users who receive DL signals through the same time and frequency resource.

To understand this procedure in detail, we must first look at when one SRS resource is allocated to each user, instead of T1R4 TAS SRS resources, (because of limited user capability or insufficient SRS resources). The system tries to communicate with K users through the same time/frequency resources, the base station constructs a $(K \times M)$ MIMO channel matrix from the SRS channel response received at each M antenna port. The method of forcing the beams towards other users equal zero - using the given channel matrix - is called a zero-forcing precoding.

If a user supports SRS TAS (e.g., T1R4), in DL MU-MIMO, it is possible for the user to be allocated with multiple layers or for a user-specific precoding to be applied as to maximize the receive performance of the user. With this assumption, the channel matrix size increases as $(4K \times M)$. The number of layers per user and the BF weights are determined to minimize the interference to the other users and to maximize the MIMO capacity to the desired user.

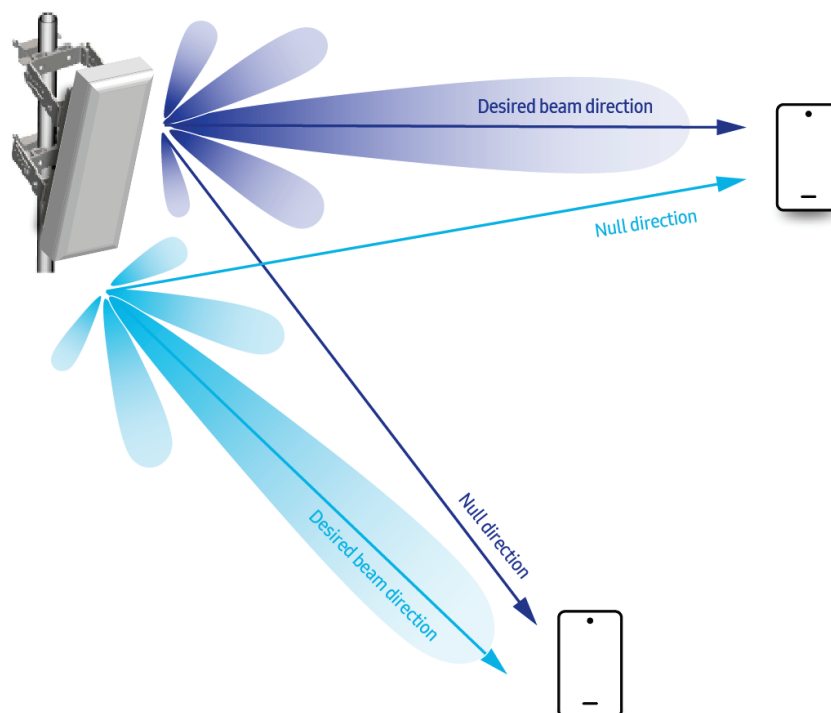

Figure 10. Beam Relation for DL MU-MIMO

In FDD, where channel reciprocity is not guaranteed, PMI should be used for channel acquisition of DL MU-MIMO instead of SRS. The NR physical layer standard has defined an expanded codebook, the type-II CSI, to include linear combinations of multiple oversampled DFT vectors. To achieve this, however, the maximum number of layers has been which is limited to 2. In order to reduce CSI quantization error in frequency selective channels, the sub band PMI can be configured in addition to the existing wideband PMI. Those CSIs with higher resolutions significantly increase the amount of feedback overhead. Despite of their reduced quantization errors, PMI-based MU-MIMO still needs to be further studied to improve its performance because of the MU-MIMO requirement of eliminating interferences to other users when using the CSI of a specific user.

User Selection of Downlink Multi-User MIMO

Allocating as many users and layers as possible does not always maximize the entire cell throughput. Due to the limited transmit power of the base station, when the number of MIMO layers increases, the transmit power per layer (or equivalently beam gain per layer) decreases. In the case of DL MU-MIMO that requires accurate inter-beam orthogonality to avoid multi-user interference, selecting the user group that shares the time and frequency resources can make a significant difference in the system performance. The typical methods of MIMO user selection are as follows:

Sum-rate maximization

This is a way to maximize the sum of data-rates expected from K layers of DL MU-MIMO. The channel vector of a newly added user/layer is expressed as the sum of two vectors: \mathbf{h}_k^{\parallel} , located on the subspace of the other users' channel vectors and \mathbf{h}_k^{\perp} , situated on the null space orthogonal to the other channel vectors. The k -th user's received SNR in the given DL-MIMO user group is proportional to \mathbf{h}_k^{\perp} . By mapping the SNR to the corresponding data rate, the user's expected data-rate can be directly acquired. Hence, the maximization of a sum-rate is achieved by creating a group of users, whose channels are as mutually orthogonal as possible. The procedure of selecting K users out of K_{total} candidate users demands significant complexity as both variable K and K_{total} , become larger. As a remedy, a variety of suboptimal solutions, with relatively low complexity and minimum performance loss, such as greedy user selection or semi-orthogonal user selection have been proposed for actual implementation algorithm.

Sum-PF maximization

To simply maximize the sum of the expected throughputs might ruin scheduling fairness of the system. For example, a certain user whose channel is ill-matched with other users' might miss scheduling opportunities consecutively regardless of its priority. In order to secure quality-of-service and fair opportunities for subscribers, a general scheduler chooses which users to be scheduled based on proportional fairness (PF) metric, which is defined as a ratio of an expected throughput based on the channel quality estimated for the instance and a served average data rate. Since the expected throughput of a specific user depends on how other members of the MU-MIMO group are chosen, maximizing the sum of PF metric is an alternative approach of meeting both requirements of throughput and fairness.

Performance Comparison by Simulation

The effectiveness, and ultimately the performance gain, of each DL MIMO scheme is verified by SLS. The simulation parameters used in SLS are summarized in Table 2.

The evaluation and standardization of MIMO in 3GPP was based on 2D model, which did not capture the elevation characteristics, the benefits, and the use cases of massive MIMO. 3D spatial channel models (3D-SCM)

are defined in [10] as a way to evaluate horizontal and vertical beamforming performance. According to the deployment condition of base station antennas, cell coverage radius, and the heights of buildings' in the cell coverage, a few channel models are defined. Of the different channel models, the 3D urban macro channel model – which closely resembles the high power massive MIMO radio deployment environment of a typical city area – was used in simulations to compare performances.

In the channel model, 80% of the users are assumed to be located inside of the buildings, which have eight floors including the ground floor. Assuming that the height of each floor (3 meters) and human (1.5 meters) are included, the effective heights of the users are uniformly distributed between 1.5 m to 22.5 m above ground by means of 3D extension of user distribution models. All indoor users experience additional propagation loss caused by outdoor-to-indoor penetration.

Since the NR physical layer has a very high degree of freedom in system configuration options that significantly affect the resource overhead and detailed link performance, the specific number of system throughput in bit-per-second does not have important physical meaning. Instead, to observe the massive MIMO radio performance improvements, the relative gains of DL-MIMO schemes over the cell average throughput using a legacy 4T4R sector antenna are compared, as shown in Figure 11 and Figure 12.

Table 2. Parameters for system level simulation

Category	Parameter	Value
System configuration	Carrier frequency	3.5 GHz
	Channel bandwidth	100 MHz
Spatial channel model	Channel model	3D Urban Macro
	Inter-site distance	500 m
	Base station antenna height	25 m
	UE antenna configuration	4 Rx with cross-polarization (+/-45°)
	UE antenna height	1.5 m ~ 22.5 m for indoor UE (80%) 1.5 m for outdoor UE (20%)
	Base-station Transmit power	100 Watt for all types of radios
User configuration	Velocity	3 km/h
	SRS periodicity	40 msec to hop over the entire bandwidth
	PMI feedback	Wideband PMI with 40 msec periodicity
	DL traffic model	Full buffer traffic

Several interesting points are observed from the results:

- DL SU-MIMO with a 32T32R massive MIMO radio system shows a gain from 23% to 64% in terms of average cell throughput compared with 4T4R legacy antenna system according to different CSI acquisition and beamforming methods.
- SU-MIMO using four port beamformed CSI-RS has a relatively lower gain than the other MIMO schemes, but still, 23% gain over 4T4R is expected.
- It appears that the expected relative throughput of (T1R4 TAS) SRS-based SU-MIMO is higher than that of PMI-based SU-MIMO. The result is based on the assumption that both periodicities of PMI report and SRS are 40 msec and that the user mobility speed is 3 km/h. If PMI report periodicity is set to be lower or the user is moving faster, PMI-based SU-MIMO might show a higher gain.

- DL SU-MIMO modes with a 64T64R massive MIMO system are expected to increase gains over the average throughput of 4T4R legacy antenna system by a range of 78% to 90%. The user-specific beam gain of the 64T64R massive MIMO radio is enhanced by 3 dB over that of the 32T32R's. Such gain results in about 22% additional throughput gain for the 64T64R massive MIMO radio of PMI-based SU-MIMO mode over the 32T32R massive MIMO radio of PMI-based SU-MIMO, and 26% gain for the 64T64R massive MIMO radio of SRS-based SU-MIMO mode over the 32T32R massive MIMO radio of SRS-based SU-MIMO.
- Since the standard only defines up to 32 port codebooks, applying PMI-based SU-MIMO with 64T64R massive MIMO radios requires a procedure that decimates 64 physical antenna ports into 32 ports. Here, it is assumed that 32 port (user-specifically) beamformed CSI-RS is used. On the contrary, for SRS-based SU-MIMO, the base station is able to estimate SRS responses at 64 receive antenna ports and calculate the corresponding user-specific beam of 64 transmit ports without any standard limitation.
- The maximum numbers of DL MU-MIMO layers are assumed to be limited to eight layers for the 32T32R massive MIMO radio and 16 layers for the 64T64R massive MIMO radio in order to guarantee the minimum beam gain. Their relative gains are 77% and 136%, which are higher than those of other SU-MIMO schemes. The throughput gain of 16 layer MU-MIMO by 64T64R massive MIMO radio has nearly twice the throughput gain of the eight layer MU-MIMO by 32T32R massive MIMO radio. The gain is based on the assumption of heavy user traffic model (full buffer) and user distribution for good orthogonality between user radio channels. The value can be interpreted as an expected peak capacity of the cell, but it does not necessarily mean there will be an increase of data volume in commercial field.

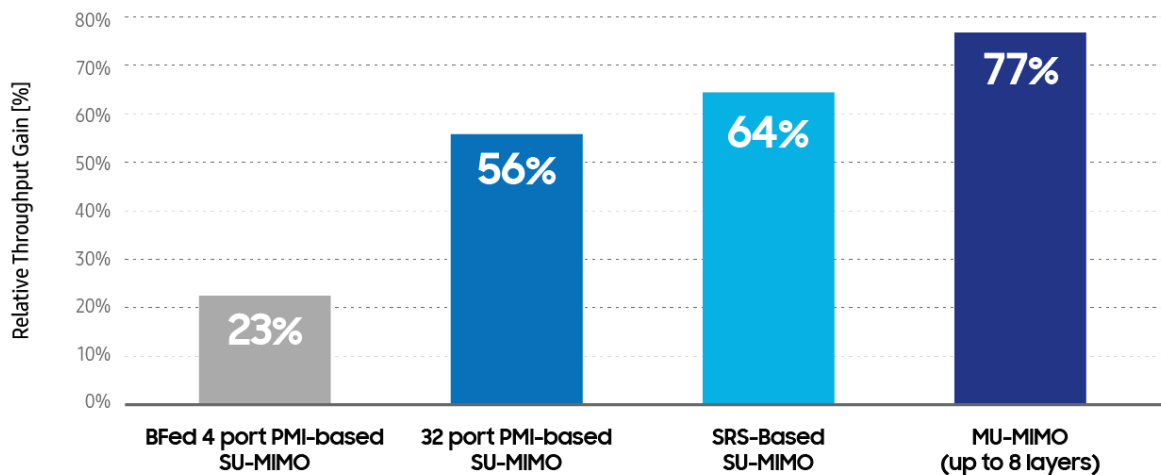

Figure 11. Comparison of average cell throughput gains of 32T32R's various DL MIMO modes over 4T4R's

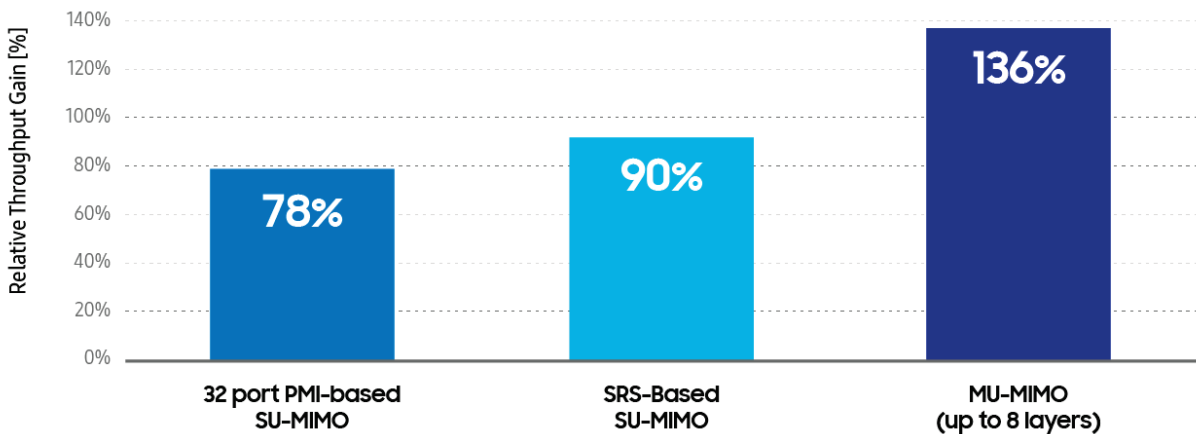

Figure 12. Comparison of average cell throughput gains of 64T64R's various DL MIMO modes over 4T4R's

Samsung's View on Massive MIMO

Hardware Plan for Massive MIMO Radio

Samsung's plans for future massive MIMO radio hardware model release is summarized below in Figure 13. Both 8T8R and 4T4R products are excluded in the figure as they do not belong to the massive MIMO radio hardware group. Subsequent massive MIMO radio products will evolve with the following specifications:

- In the earliest stages, products have relatively simple functionalities to allow for quick deployment. In terms of their weight and size, the products have configurations that allow easy installation and high reusability of the existing infrastructure. At the request of MNOs, each of the products supports various frequency bands.
- Although early products are mainly in 32T32R, once 5G NR commercialization becomes mature and their traffic demands explosively increase, new 64T64R products will be released to expand the capacity especially for dense urban areas. They will support transmit power sufficient for RAN sharing.
- By the third stage, in order to support MNO's various conditions of spectrum allocation, products with wide instantaneous bandwidth (IBW) will be released.

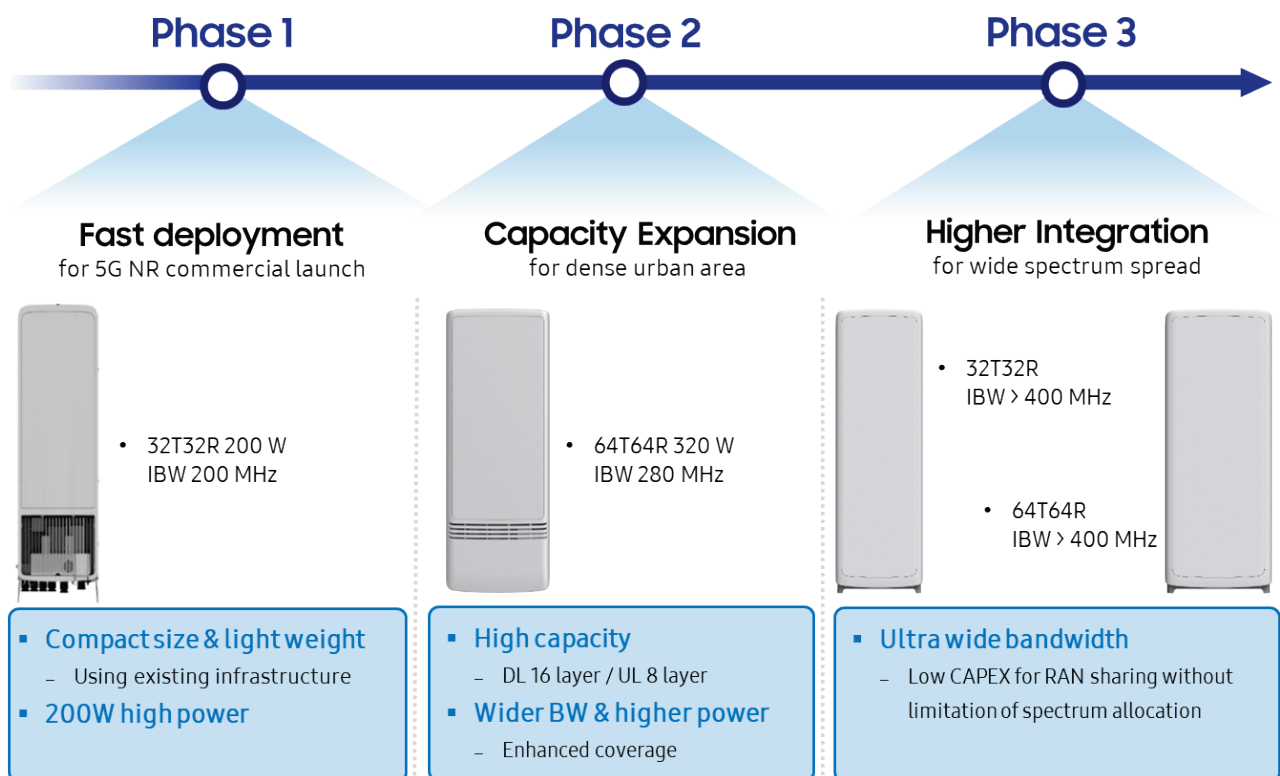

Figure 13. Samsung's plan for massive MIMO radio hardware evolution

Software Plan for Massive MIMO

Figure 14 shows Samsung's RAN software plan for massive MIMO radio. Various DL MIMO schemes such as SRS-based SU-MIMO for devices equipped with TAS capability 'T1R4', 32 port PMI-based SU-MIMO, DL SU-MIMO based on 'beamformed CSI-RS' for devices without TAS capability or 32 port PMI report, and DL MU-MIMO with maximum 8 layers are already available or to be released soon.

The best DL MIMO scheme in maximizing the user experience and cell performance might change according to user capability, mobility, received signal strength, availability of limited SRS resources, and traffic load condition. Samsung's software solution for massive MIMO provides not just individual DL MIMO modes but dynamically switches the serviced MIMO mode to the best fit one for the given conditions.

In the case of path-failures in a massive MIMO radio, which introduces a reduced cell-coverage and distorted common beam pattern, self-healing feature recovers the common beam to minimize the loss of antenna gain.

The maximum number of DL/UL MU-MIMO layers will be increased according to the release of 64T64R massive MIMO radio hardware. Long-term enhancement features such as FDD massive MIMO and MIMO enhancement in 3GPP release 16 and 17 are to be released in coming years.



Figure 14. Samsung's roadmap for massive MIMO software

Summary

This paper highlights the basic principles and technologies of massive MIMO in 5G NR system. Utilizing a large number of antennas generates sharp user-specific beams and strengthens the received signal power. In addition, it reduces the amount of interference toward other users. As a result, massive number of antennas are able to improve the overall signal quality.

Depending on how antenna elements are placed, the massive MIMO system can take on various form factors. By breaking down the massive MIMO radio hardware into their individual components, features of the massive MIMO radio hardware can be evaluated. Angular coverage is one of the major features that determine the performance of a massive MIMO system, especially when it is set up in skyscrapers or stadiums and the connected users are spread across in horizontal and vertical orientations.

Software to support the various MIMO schemes is necessary for massive MIMO hardware to improve the overall system performance in commercial fields. Depending on the CSI acquisition methods, MIMO schemes are categorized into SRS-based SU-MIMO, PMI-based SU-MIMO, and beam formed CSI-RS MIMO for low capability devices. Based on the device's capability and electric field condition, Samsung's solution decides the best MIMO mode. In addition, when multiple users demand high load traffic simultaneously in a TDD system, DL MU-MIMO solution, which allocates mutually orthogonal beams to the users, is able to enhance the cell throughput and user experience.

3GPP standard plans to further make MIMO enhancements for massive MIMO such as DL MU-MIMO operation in FDD and CSI feedback reduction. Consequently, performance of the massive MIMO system in 5G NR is expected to evolve over time.

References

- [1] Y. H. Nam et al., "Full-Dimension MIMO (FD-MIMO) for Next Generation Cellular Technology," *IEEE Communication Magazine*, vol. 51, issue 6, Jun. 2013.
- [2] Y. Kim et al., "Full Dimension MIMO (FD-MIMO): The Next Evolution of MIMO in LTE Systems," *IEEE Trans. Wireless Communications*, vol. 21, issue 3, Apr. 2014.
- [3] E. Björnson, E. G. Larsson and T. L. Marzetta, "Massive MIMO: Ten myths and One critical question," *IEEE Communications Magazine*, vol. 54, no. 2, pp. 114-123, Feb. 2016,
- [4] T. L. Marzetta, "Non-cooperative Cellular Wireless with Unlimited Numbers of Base Station Antennas," *IEEE Trans. Wireless Communications*, vol. 9, No. 11, Nov. 2010.
- [5] H. Ji, et al., "Overview of Full-Dimension MIMO in LTE-Advanced Pro," *IEEE Communication Magazine*, vol. 55, issue 2, Feb. 2017.
- [6] Samsung Electronics, "5G in Korea - Volume 2: Korea's 5G Continues Exceeding Expectations," 2020 [Online] Available: <https://www.samsung.com/global/business/networks/insights/?white-paper+case-study>.
- [7] 3GPP TS 38.212: "NR; Multiplexing and channel coding"
- [8] 3GPP TS 38.213: "NR; Physical layer procedures for control"
- [9] 3GPP TS 38.214: "NR; Physical layer procedures for data"
- [10] 3GPP TR 38.901: "5G; Study on Channel model for frequency 0.5 to 100 GHz "

SAMSUNG

About Samsung Electronics Co., Ltd.

Samsung inspires the world and shapes the future with transformative ideas and technologies.

The company is redefining the worlds of TVs, smartphones, wearable devices, tablets, digital appliances, network systems, and memory, system LSI, foundry and LED solutions.

Address : 129 Samsung-ro, Yeongtong-gu, Suwon-si Gyeonggi-do, Korea

2020 Samsung Electronics Co., Ltd.

All rights reserved. Information in this leaflet is proprietary to Samsung Electronics Co., Ltd. and is subject to change without notice.

No information contained here may be copied, translated, transcribed or duplicated by any form without the prior written consent of Samsung Electronics.